



IRIMO

Catálogo - Tarifa
2024



Visita nuestra
página web

90

MÁS DE

AÑOS DE HISTORIA SOLO ES EL INICIO

Todo comenzó en los años 30 en un pequeño pueblo del País Vasco, en el norte de España. Fabricábamos ejes para carros y bolas de molino para cementeras. Década tras década, fuimos forjando nuestro carácter creativo lanzando herramientas como la llave ajustable inglesa de moleta lateral, tan utilizada a lo largo de los años.

Hoy mantenemos nuestro compromiso con la mejora continua adaptándonos a las necesidades de los profesionales que aprecian su caja de herramientas.



IRIMO

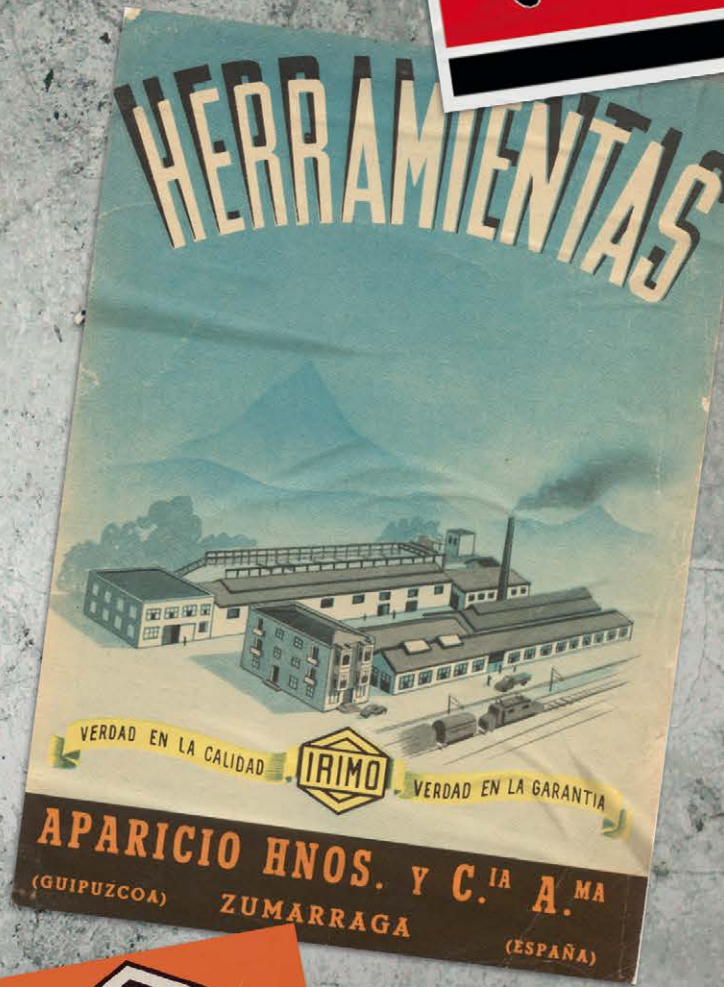

IRIMO

EL ORIGEN ES IMPORTANTE EL DESTINO, AÚN MÁS

QUEREMOS ESTAR DONDE NOS NECESITES.
POR ESO, NUESTRA PRESENCIA ES MAYOR CADA DÍA.

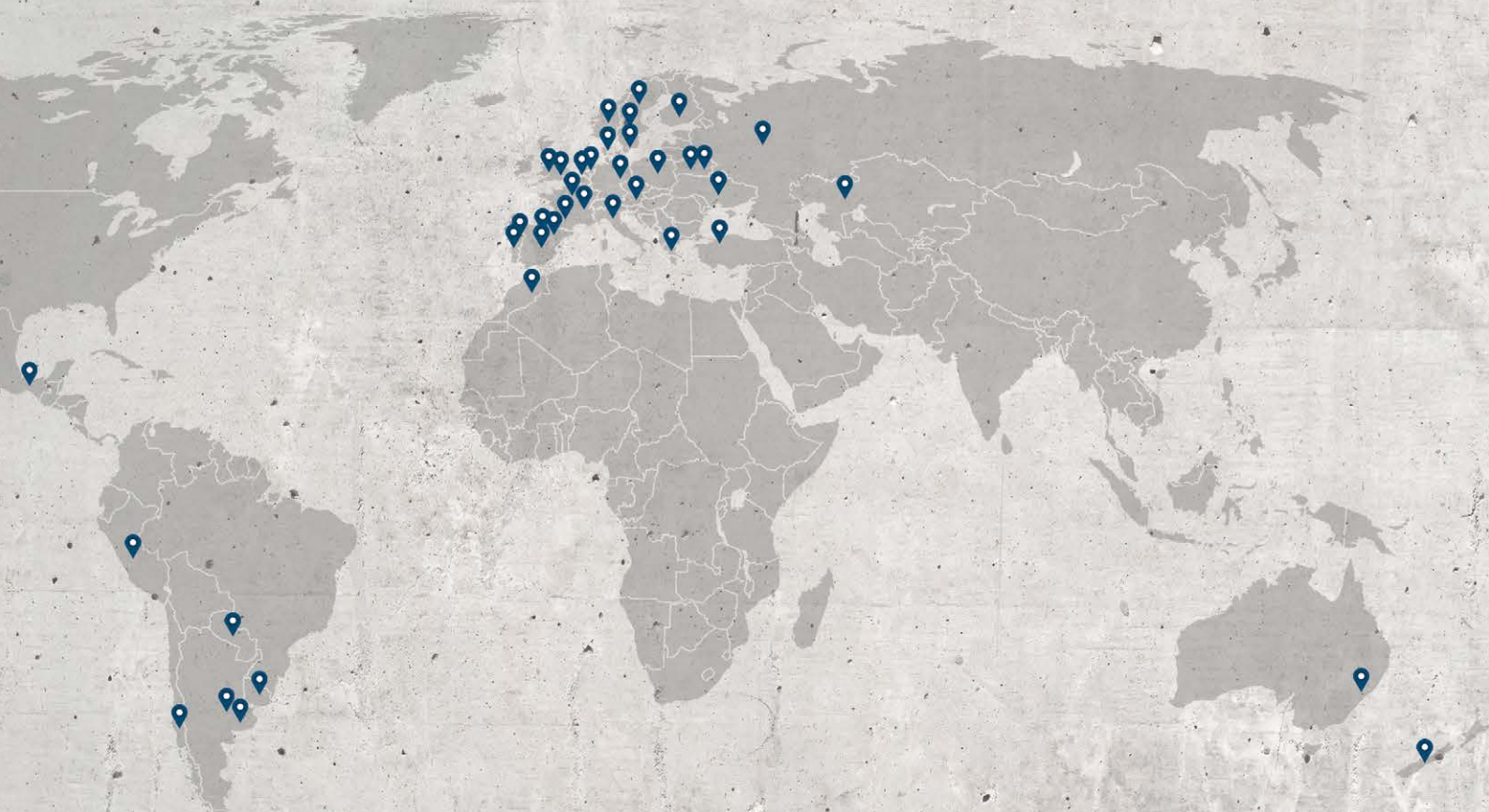

ALEMANIA

FINLANDIA

POLONIA

AUSTRALIA Y NUEVA ZELANDA

FRANCIA

PORTUGAL

BÉLGICA

GRECIA

RUSIA

CHILE

ITALIA

SUECIA

DINAMARCA

NORUEGA

SUIZA

ESPAÑA

PAÍSES BAJOS

TURQUÍA



VISITA NUESTRA WEB

WWW.IRIMO.COM

- TODO LO QUE NECESITAS SABER SOBRE NOSOTROS
- FOTOS EXPLICATIVAS DE PRODUCTO
- INFORMACIÓN COMPLETA DE NUESTROS NUEVOS PRODUCTOS
- DESCARGA CADA HOJA DE PRODUCTO EN PDF
- CONEXIÓN CON REDES SOCIALES
- DÓNDE COMPRAR

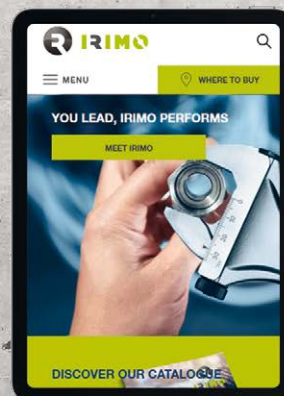
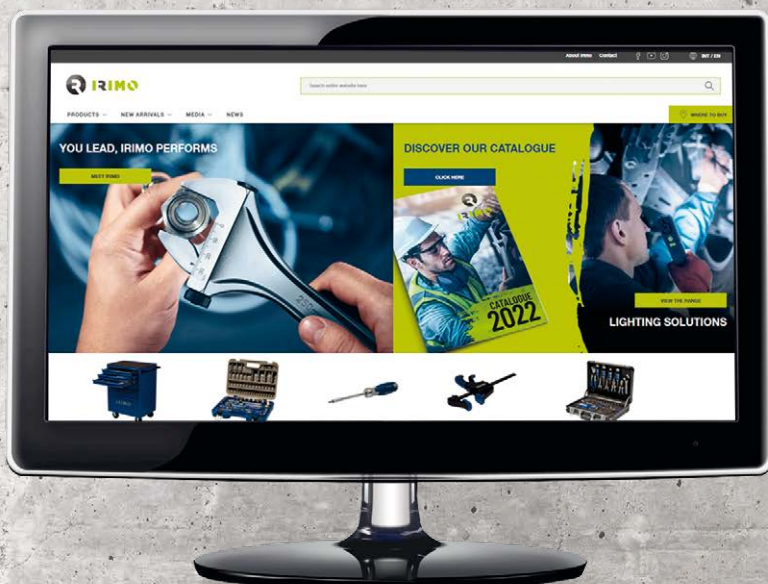

➔	ÍNDICE	9-12
➔	ÍNDICE ALFANUMÉRICO	194-206
➔	GARANTÍA	213
	CONDICIONES DE VENTA	214

ÍNDICE DE HERRAMIENTAS

1. ALMACENAMIENTO DE HERRAMIENTAS

13



2. LLAVES

35



3. HERRAMIENTAS DINAMOMÉTRICAS

51



4. VASOS Y ACCESORIOS

55



5. TORNILLOS DE BANCO

85



6. HERRAMIENTAS PARA TUBO

93



7. DESTORNILLADORES Y PUNTAS

99



DESTORNILLADORES



PUNTAS



8. HERRAMIENTAS DE GOLPEO

133



10. HERRAMIENTAS DE EXTRACCIÓN

163



11. HERRAMIENTAS DE CORTE Y MEDICIÓN

169



HERRAMIENTAS DE CORTE



MEDICIÓN



9. ALICATES - TIJERAS Y CUCHILLOS

145



ALICATES



TIJERAS Y CUCHILLOS



12. ILUMINACIÓN Y HERRAMIENTAS NEUMÁTICAS Y A BATERÍA

183





A

Accesorios 1/4"	58
Accesorios 3/8"	62
Accesorios 1/2"	67
Accesorios 3/4"	75
Accesorios Impacto 3/8"	78
Accesorios Impacto 1/2"	81
Accesorios Impacto 3/4"	82
Accesorios Impacto 1"	84
Adaptador Puntas 3/8"	63
Adaptador Puntas 1/2"	70
Ajustables	36
Alicate Pelacables	149
Alicates (1000V)	151
Alicates Arandelas	155
Alicates para Terminales Aislados	150
Aprietos	90
Arco Tronzador	170
Arcos para Metales	171
Atornillador a Batería	189

B

Banco de trabajo de acero resistente	26
Banco de Trabajo Plegable	27
Barras para Desencofrador	138
Bolsa para Transporte Herramienta	30
Botadores	134
Buriles	134
Buscapolos	111

C

Cabeza Intercambiable Dinamométrica	52
Caja Herramientas de Plástico	29

Caja Metálica	27
Calibres	179
Carraca 1/4"	58
Carraca 3/8"	62
Carraca 1/2"	67
Carraca 3/4"	75
Carraca Neumática	188
Carros	14
Carro con Cajas Apilables	24
Carro Dos Bandejas	25
Cinta Métrica	177
Cofre 4 Cajones	14
Corta Cables	149
Cortafrios	134
Cortatubos	96
Cortatubos de Plástico Auto-retráctil	96
Cortavarillas	154
Cuchillo Electricista	161
Cuchillo Multiusos con Funda	161
Cutters	160

D

Destornilladores	100
Destornilladores Aislados (1000V)	104
Destornilladores de Carraca	103
Destornillador Mango T	108
Destornilladores Precisión	111
Destorgolpe 5/16"	129
Destornillador Reversible	110
Destornilladores Stecker	103
Dinamométricas	52
Destornillador Portapuntas Carraca	103

E

Escuadras	178
Espátulas Carrocero	180
Espátulas Pintor	180
Estuches Porta-herramientas	32
Expositores Destornilladores	107
Extractores	164
Extractor Espárragos	166
Extractor Magnético	167

F

Filtros	189
Flexómetros	176
Foams para Carros	18
Formones	144

G

Galgas	178
Granetes	135
Grapadoras	181
Grips	156

H

Hoja Bimetal	171
Hojas de Tronzar	170

I

Iluminación	184
-------------	-----

J

Juego Alicates (1000V)	152
Juego Alicates para Engastar con Mordazas Intercambiables	151

Juego Botadores	136
Juego Coronas	172
Juego Destorgolpe	129
Juego Destornilladores	105
Juego Destornilladores (1000V)	108
Juego Espátulas Carrocero	180
Juego Formones	144
Juego Ganchos	162
Juego Granetes	135
Juego Gubias para Talla	144
Juego Limas	173
Juego Llaves Ajustables Inglesas	37
Juego Llaves Combinadas	40
Juego Llaves Combinadas con Carraca	41
Juego Llaves Estrella	44
Juego Llaves Fijas	38
Juego Llaves Pipa Abiertas	46
Juego Llaves Tubo	47
Juego Mordazas Grip	158
Juego Palancas	168
Juego Puntas Tablets 4 mm	127
Juego Puntas 1/4"	126
Juego Puntas 10 mm	132
Juego Remachadora Manual	159
Juego Sacabocados	97
Juego Terminales Aislados y Conectores de Enchufe	151
Juego Vasos 1/4"	60
Juego Vasos 3/8"	63
Juego Vasos 1/2"	70
Juego Vasos 3/4"	76
Juego Vasos Impacto 1/2"	79
Juego Vasos Impacto 3/4"	81
Juego Vasos Impacto 1"	82

L

Lámparas de Bolsillo	184
Lámparas de Inspección	185
Lámparas de Trabajo	186
Lámparas Frontales	186
Limas	172
Linterna de Aluminio	185
Lubricadores	188
Llave Cadena	95
Llaves Acodadas	112
Llaves Ajustables Inglesas	36
Llaves Combinadas	39
Llaves con Carraca	41
Llaves de Gancho	49
Llaves de Golpe	48
Llaves Dinamométricas	52
Llaves Estrella Plana	44
Llaves Fijas	37
Llaves Tipo Allen	112
Llaves Tipo Allen Serie Larga	113
Llaves Impacto	187
Llaves Pipa	46
Llaves Stillson	94
Llaves Tubo Mod. Sueco	95
Llaves Tubulares	47
Llaves Universales	49

M

Maceta Albañil	142
Magnetizador/Desmagnetizador	110
Martillo Antirrebote	143
Martillo Boca Nylon	143
Martillos	139
Material de Punto de Venta	191

Maza Goma	142
Mini Alicates	148
Mini Arco	172
Mini Cortatubos	96
Mochilas Porta-herramientas	31
Mordazas Ajuste Rápido	91
Mordazas Grip	156
Multiherramientas	161

N

Neumática	187
Niveles	174

P

Palanca	167
Pelacables (1000V)	153
Perforadores Chapa	168
Pistola de Cola Termofusible	180
Pistola de Silicona	180
Pistolas Impacto	187
Pistola de Calor	181
Porta Herramientas	30
Portapuntas Magnético 1/4"	102
Punta 10 mm	130
Punta Trazadora	138
Puntas 1/4"	119
Puntas 5/16"	128

R

Rasquetas	160
Regulador	189
Remachadoras	159
Repuestos de Tornillos Banco	87
Revólver Sacabocados	97

S

Sacabocados	97
Sargentos	90
Serruchos	170
Sopladora	188
Stillson	94

T

Tenacilla (1000V)	153
Tenaza Ajuste Rápido	147
Tenaza Carpintero	153
Tenaza Rusa	153
Termómetro Infrarrojos	179
Tijeras Cortachapas	156
Tijeras Electricista	162
Tornillos Banco	86
Tornillos Banco Sobremesa	89
Transportador	25
Trazador	138
Tronzatuercas	166

V

Vasos 1/4"	56
Vasos 3/8"	61
Vasos 1/2"	64
Vasos 3/4"	74
Vasos con Punta 1/4"	57
Vasos con Punta 1/2"	66
Vasos Impacto 3/8"	77
Vasos Impacto 1/2"	79
Vasos Impacto 3/4"	82
Vasos Impacto 1"	83
Volvedor	166



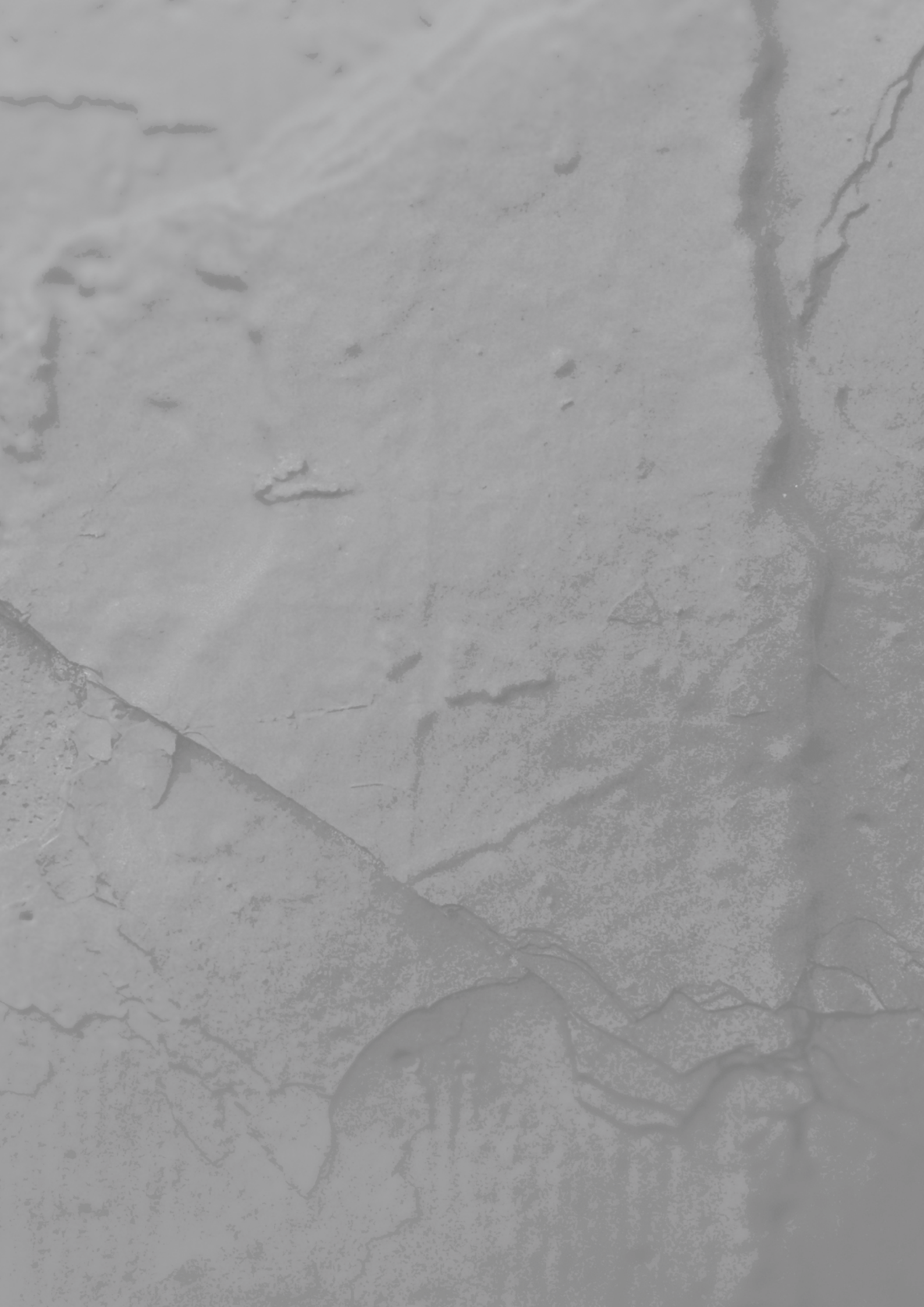



01. ALMACENAMIENTO DE HERRAMIENTAS





CARROS

CARRO DE 5 CAJONES



CARRO DE 6 CAJONES



CARRO DE 7 CAJONES



- Carro 5 cajones robusto
 - Dimensiones interiores de los cajones:
 - (1 x) 543 x 445 x 50 mm
 - (2 x) 543 x 445 x 116 mm
 - (2 x) 543 x 445 x 182 mm
 - Gran capacidad
 - Chasis doble pared que protege los laterales para no dañar los cajones ante golpes
 - Reforzado en sitios claves para evitar puntos débiles
 - Guías de rodamientos de bolas en los cajones con 100% de apertura
 - Sistema 'click' de apertura y cierre de cajones
 - Sistema de cierre seguro y robusto
 - Ruedas de 125 x 30 mm con rodamientos de bola y goma que no marca:
 - 2 fijas y 2 giratorias con freno
- Carro 6 cajones robusto
 - Dimensiones interiores de los cajones:
 - (3 x) 543 x 445 x 50 mm
 - (2 x) 543 x 445 x 116 mm
 - (1 x) 543 x 445 x 246 mm
- Carro 7 cajones robusto
 - Dimensiones interiores de los cajones:
 - (5 x) 543 x 445 x 50 mm
 - (1 x) 543 x 445 x 116 mm
 - (1 x) 543 x 445 x 246 mm

R	Icono	Altura (mm)	Profundidad (mm)	Anchura (mm)	Capacidad (kg)	Ruedas (mm)	Peso (kg)	€		
9066K5	1	677	501	954	400	543 x 445 x h	25	125 x 30	48	798,42
9066K6	1	677	501	954	400	543 x 445 x h	25	125 x 30	51	830,00
9066K7	1	677	501	954	400	543 x 445 x h	25	125 x 30	52	856,89

COFRE DE 4 CAJONES



REPUESTOS

Repuesto	Descripción	€
9066K-01	Guías (2x) - 30 kg de capacidad	18,85
9066K-02	Dos ruedas giratorias de 125 x 30 mm	29,68
9066K-03	Dos ruedas fijas de 125 x 30 mm	24,63
9066K-05	Asa lateral para serie 9066K	28,38
9066K-06	Encimera de goma	13,71
9064-15	Asas laterales para cofre	18,95
9064AC01	Set 7 alfombrillas protectoras para los cajones	18,29

- Cofre 4 cajones robusto
- Gran capacidad
- Chasis doble pared que protege los laterales para no dañar los cajones ante golpes
- Reforzado en sitios claves para evitar puntos débiles
- Guías de rodamientos de bolas en los cajones con 100% de apertura
- Sistema 'click' de apertura y cierre de cajones
- Sistema de cierre seguro y robusto
- Dimensiones interiores de los cajones:
 - (3 x) 543 x 445 x 50 mm
 - (1 x) 543 x 445 x 116 mm

R	Icono	Altura (mm)	Profundidad (mm)	Anchura (mm)	Capacidad (kg)	Peso (kg)	€		
9065K4	1	677	501	420	250	543 x 445 x h	25	38	587,33

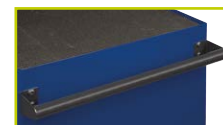
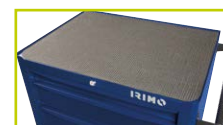



CARRO DE 6 CAJONES CON FOAMS Y HERRAMIENTAS, 206 piezas



IFF1A001



IFF1A002



IFF1A003

9066K6FF100	1	677 x 501 x 954	80	1.235,34

IFF1A001

045001, 045011, 045021	
101-04-1, 101-045-1, 101-05-1, 101-055-1, 101-06-1, 101-07-1, 101-08-1, 101-09-1, 101-10-1, 101-11-1, 101-12-1, 101-13-1, 101-14-1	
103-04-1, 103-05-1, 103-06-1, 103-07-1, 103-08-1, 103-09-1, 103-10-1, 103-11-1, 103-12-1, 103-13-1	
105-22-1, 105-24-1	
105-40-1	
105-42-1	
105-48-1	
105-50-1	
105-70-1	
106-04-1, 106-05-1, 106-06-1, 106-07-1, 106-08-1	
121-10-1, 121-11-1, 121-12-1, 121-13-1, 121-14-1, 121-15-1, 121-16-1, 121-17-1, 121-18-1, 121-19-1, 121-20-1, 121-21-1, 121-22-1, 121-24-1, 121-27-1, 121-30-1, 121-32-1	
125-23-1, 125-25-1	
125-40-1	
125-42-1	
125-48-1	
125-53-1, 125-54-1	
124-14-1, 124-15-1, 124-17-1, 124-19-1, 124-22-1	
125-70-1	
126-10-1, 126-11-1, 126-12-1, 126-14-1, 126-16-1, 126-18-1, 126-20-1, 126-24-1	
475-4-1, 475-5.5-1, 475-6.5-1	
475-H3-1, 475-H4-1, 475-H5-1, 475-H6-1	
475-PH1-1, 475-PH2-1	
475-PZ1-1, 475-PZ2-1	
475-T8-1, 475-T10-1, 475-T15-1, 475-T20-1, 475-T25-1, 475-T27-1, 475-T30-1	

IFF1A002

529171	
475-61-1	
48-9-H	
511-105-1	
515-002-1, 515-003-1, 515-004-1, 515-005-1, 515-006-1	
5-250C-1	
527-61-2	
601-180-1	
612-160-1	
625-180-1	
634-250-1	
666-156-1	
980-38-1	

IFF1A003

25-06-2, 25-07-2, 25-08-2, 25-09-2, 25-10-2, 25-11-2, 25-12-2, 25-13-2, 25-14-2, 25-15-2, 25-16-2, 25-17-2, 25-18-2, 25-19-2, 25-21-2, 25-22-2, 25-24-2, 25-27-2, 25-30-2, 25-32-2	
407-4-100, 407-5.5-125, 407-6.5-150, 407-8-175	
409-1-100, 409-2-125, 409-3-150	
9066K6	





CARROS

CARRO DE 6 CAJONES CON FOAMS Y HERRAMIENTAS, 178 piezas



IFF1A004



IFF1A005



IFF1A006

9066K6FF101	1	677 x 501 x 950	80	1.418,83

IFF1A004

101-04-1, 101-045-1, 101-05-1, 101-055-1, 101-06-1, 101-07-1, 101-08-1, 101-09-1, 101-10-1, 101-11-1, 101-12-1, 101-13-1		$\frac{1}{4}$
103-04-1, 103-05-1, 103-06-1, 103-07-1, 103-08-1, 103-09-1, 103-10-1, 103-11-1, 103-12-1, 103-13-1		$\frac{1}{4}$
105-22-1, 105-24-1		
105-40-1		
105-42-1		
105-48-1		
105-50-1		
105-70-1		
121-10-1, 121-11-1, 121-12-1, 121-13-1, 121-14-1, 121-15-1, 121-17-1, 121-19-1, 121-22-1, 121-24-1, 121-27-1, 121-30-1, 121-32-1		$\frac{1}{2}$
125-23-1, 125-25-1		
125-40-1		
125-42-1		
125-48-1		
125-54-1		
125-70-1		
407-4-100, 407-5.5-125, 407-6.5-150, 407-8-175		
408-6.5-25		
409-1-100, 409-2-125, 409-3-150		
409-2-25		
413-1-100, 413-2-125		

IFF1A005

529171	
527-61-2	
475-61-1	
48-9-H	
501-250-1	
511-105-1	
515-002-1, 515-003-1, 515-004-1, 515-005-1, 515-006-1	
5-150C-1, 5-250C-1	
601-180-1	
612-160-1	
625-180-1	
634-250-1	
665-200-1	
980-3B-1	

IFF1A006

25-06-2, 25-07-2, 25-08-2, 25-09-2, 25-10-2, 25-11-2, 25-12-2, 25-13-2, 25-14-2, 25-15-2, 25-16-2, 25-17-2, 25-18-2, 25-19-2, 25-21-2, 25-22-2, 25-24-2, 25-27-2, 25-30-2, 25-32-2	
10-0607-1, 10-0809-1, 10-1011-1, 10-1213-1, 10-1415-1, 10-1617-1, 10-1819-1, 10-2022-1, 10-2123-1, 10-2427-1, 10-3032-1	
9066K6	



CARRO DE 7 CAJONES CON FOAMS Y HERRAMIENTAS, 222 piezas



IFF1A004



IFF1A005



IFF1A006



IFF1A007

9066K7FF102	1	677 x 501 x 954	90	1.649,29

IFF1A004

101-04-1, 101-045-1, 101-05-1, 101-055-1, 101-06-1, 101-07-1, 101-08-1, 101-09-1, 101-10-1, 101-11-1, 101-12-1, 101-13-1		
103-04-1, 103-05-1, 103-06-1, 103-07-1, 103-08-1, 103-09-1, 103-10-1, 103-11-1, 103-12-1, 103-13-1		
105-22-1, 105-24-1		
105-40-1		
105-42-1		
105-48-1		
105-50-1		
105-70-1		
121-10-1, 121-11-1, 121-12-1, 121-13-1, 121-14-1, 121-15-1, 121-17-1, 121-19-1, 121-22-1, 121-24-1, 121-27-1, 121-30-1, 121-32-1		
125-23-1, 125-25-1		
125-40-1		
125-42-1		
125-48-1		
125-54-1		
125-70-1		
407-4-100, 407-5-5-125, 407-6-5-150, 407-8-175		
408-6-5-25		
409-1-100, 409-2-125, 409-3-150		
409-2-25		
413-1-100, 413-2-125		

IFF1A005

529171	
527-61-2	
475-61-1	
48-9-H	
501-250-1	
511-105-1	
515-002-1, 515-003-1, 515-004-1, 515-005-1, 515-006-1	
5-150C-1, 5-250C-1	
601-180-1	
612-160-1	
625-180-1	
634-250-1	
665-200-1	
980-3B-1	

IFF1A006

25-06-2, 25-07-2, 25-08-2, 25-09-2, 25-10-2, 25-11-2, 25-12-2, 25-13-2, 25-14-2, 25-15-2, 25-16-2, 25-17-2, 25-18-2, 25-19-2, 25-21-2, 25-22-2, 25-24-2, 25-27-2, 25-30-2, 25-32-2	
10-0607-1, 10-0809-1, 10-1011-1, 10-1213-1, 10-1415-1, 10-1617-1, 10-1819-1, 10-2022-1, 10-2123-1, 10-2427-1, 10-3032-1	

IFF1A007

534261	
534291	
534321	
534351	
534381	
534411	
180-05-1, 180-06-1, 180-07-1, 180-08-1, 180-10-1, 180-12-1, 180-14-1, 180-17-1	
180-05X-1, 180-06X-1, 180-07X-1, 180-08X-1, 180-10X-1, 180-12X-1	
183-30-1, 183-40-1, 183-45-1, 183-50-1, 183-55-1, 183-60-1	
183-40X-1, 183-45X-1, 183-50X-1, 183-55X-1	
458-8-F	
716-M6-1, 716-M8-1, 716-M11-1, 716-M14-1, 716-M18-1,	
801-145-1	
9066K7	





BANDEJAS DE FOAM 3/3 PARA CARROS DE 26"

IFF1A001



- Foam 3/3 con vasos, carracas y puntas
- 94 piezas

R	Tray	€	
IFF1A001	1	445 x 543 x 40	172,07

045001, 045011, 045021

101-04-1, 101-045-1, 101-05-1, 101-055-1, 101-06-1, 101-07-1, 101-08-1, 101-09-1, 101-10-1, 101-11-1, 101-12-1, 101-13-1, 101-14-1

103-04-1, 103-05-1, 103-06-1, 103-07-1, 103-08-1, 103-09-1, 103-10-1, 103-11-1, 103-12-1, 103-13-1

105-22-1, 105-24-1

105-40-1

105-42-1

105-48-1

105-50-1

105-70-1

106-04-1, 106-05-1, 106-06-1, 106-07-1, 106-08-1

121-10-1, 121-11-1, 121-12-1, 121-13-1, 121-14-1, 121-15-1, 121-16-1, 121-17-1, 121-18-1, 121-19-1, 121-20-1, 121-21-1, 121-22-1, 121-24-1, 121-27-1, 121-30-1, 121-32-1

125-23-1, 125-25-1

125-40-1

125-42-1

125-48-1

125-53-1, 125-54-1

124-14-1, 124-15-1, 124-17-1, 124-19-1, 124-22-1

125-70-1

126-10-1, 126-11-1, 126-12-1, 126-14-1, 126-16-1, 126-18-1, 126-20-1, 126-24-1

475-4-1, 475-5.5-1, 475-6.5-1

475-H3-1, 475-H4-1, 475-H5-1, 475-H6-1

475-PH1-1, 475-PH2-1

475-PZ1-1, 475-PZ2-1

475-T8-1, 475-T10-1, 475-T15-1, 475-T20-1, 475-T25-1, 475-T27-1, 475-T30-1

IFF1A002



- Foam 3/3 con herramientas de golpeo, herramientas de corte, cinta métrica y alicates
- 85 piezas

R	Tray	€	
IFF1A002	1	445 x 543 x 40	175,93

529171

475-61-1

48-9-H

511-105-1

515-002-1, 515-003-1, 515-004-1, 515-005-1, 515-006-1

5-250C-1

527-61-2

601-180-1

612-160-1

625-180-1

634-250-1

666-156-1

980-3B-1

IFF1A003



- Foam 3/3 con destornilladores y llaves combinadas
- 27 piezas

R	Tray	€	
IFF1A003	1	445 x 543 x 40	181,17

25-06-2, 25-07-2, 25-08-2, 25-09-2, 25-10-2, 25-11-2, 25-12-2, 25-13-2, 25-14-2, 25-15-2, 25-16-2, 25-17-2, 25-18-2, 25-19-2, 25-21-2, 25-22-2, 25-24-2, 25-27-2, 25-30-2, 25-32-2

407-4-100, 407-5-5-125, 407-6-5-150, 407-8-175

















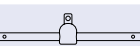







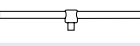

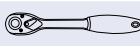

409-1-100, 409-2-125, 409-3-150

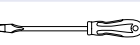

IFF1A004

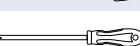















































































































































- Foam 3/3 con juego de vasos, destornilladores y carracas
- 60 piezas

R	1	445 x 543 x 40	€
IFF1A004	1	445 x 543 x 40	191,25
101-04-1, 101-045-1, 101-05-1, 101-055-1, 101-06-1, 101-07-1, 101-08-1, 101-09-1, 101-10-1, 101-11-1, 101-12-1, 101-13-1			
103-04-1, 103-05-1, 103-06-1, 103-07-1, 103-08-1, 103-09-1, 103-10-1, 103-11-1, 103-12-1, 103-13-1			
105-22-1, 105-24-1			
105-40-1			
105-42-1			
105-48-1			
105-50-1			
105-70-1			
121-10-1, 121-11-1, 121-12-1, 121-13-1, 121-14-1, 121-15-1, 121-17-1, 121-19-1, 121-22-1, 121-24-1, 121-27-1, 121-30-1, 121-32-1			
125-23-1, 125-25-1			
125-40-1			
125-42-1			
125-48-1			
125-54-1			
125-70-1			
407-4-100, 407-5-5-125, 407-6-5-150, 407-8-175			
408-6-5-25			
409-1-100, 409-2-125, 409-3-150			
409-2-25			
413-1-100, 413-2-125			

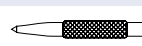
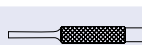
IFF1A005

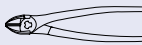

- Foam 3/3 con herramientas de golpeo, herramientas de corte y alicates
- 87 piezas

R	1	445 x 543 x 40	€
IFF1A005	1	445 x 543 x 40	218,39
529171			
527-61-2			
475-61-1	                                                                                                                                   		
48-9-H			
501-250-1			
511-105-1			
515-002-1, 515-003-1, 515-004-1, 515-005-1, 515-006-1			
5-150C-1, 5-250C-1			
601-180-1			
612-160-1			
625-180-1			
634-250-1			
665-200-1			
980-3B-1			

IFF1A006

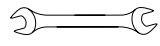

- Foam 3/3 con llaves combinadas y llaves fijas
- 31 piezas

R	1	445 x 543 x 40	€
IFF1A006	1	445 x 543 x 40	206,90
25-06-2, 25-07-2, 25-08-2, 25-09-2, 25-10-2, 25-11-2, 25-12-2, 25-13-2, 25-14-2, 25-15-2, 25-16-2, 25-17-2, 25-18-2, 25-19-2, 25-21-2, 25-22-2, 25-24-2, 25-27-2, 25-30-2, 25-32-2			
10-0607-1, 10-0809-1, 10-1011-1, 10-1213-1, 10-1415-1, 10-1617-1, 10-1819-1, 10-2022-1, 10-2123-1, 10-2427-1, 10-3032-1			

2



3



4



5



6



7



8



9



10



11



12





BANDEJAS DE FOAM 3/3 Y 1/3 PARA CARROS DE 26"

IFF1A007



- Foam 3/3 con juego de vasos, limas y herramientas de corte
- 44 piezas

			€
IFF1A007	1	445 x 543 x 40	169,73

534261		
--------	--	--

534291		
--------	--	--

534321		
--------	--	--

534351		
--------	--	--

534381		
--------	--	--

534411		
--------	--	--

180-05-1, 180-06-1, 180-07-1, 180-08-1, 180-10-1, 180-12-1, 180-14-1, 180-17-1		
--	--	--

180-05X-1, 180-06X-1, 180-07X-1, 180-08X-1, 180-10X-1, 180-12X-1		
--	--	--

183-30-1, 183-40-1, 183-45-1, 183-50-1, 183-55-1, 183-60-1		
---	--	--

183-40X-1, 183-45X-1, 183-50X-1, 183-55X-1		
---	--	--

458-8-F		
---------	--	--

716-M6-1, 716-M8-1, 716-M11-1, 716-M14-1, 716-M18-1,		
---	--	--

801-145-1		
-----------	--	--

IFF1E001

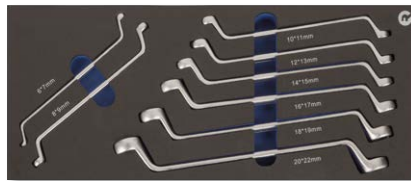

- Bandeja de foam 1/3 con llaves de estrella acodada
- 8 piezas

			€
IFF1E001	1	445 x 181 x 40	70,44

15-0607-1, 15-0809-1, 15-1011-1, 15-1213-1, 15-1415-1, 15-1617-1, 15-1819-1, 15-2022-1	
--	--

IFF1E002

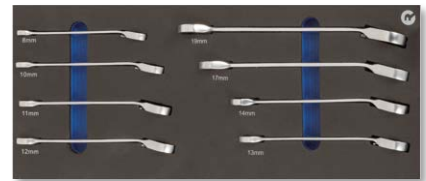

- Bandeja de foam 1/3 con llaves combinadas con carraca
- 8 piezas

			€
IFF1E002	1	445 x 181 x 40	86,11

18-08-1, 18-10-1, 18-11-1, 18-12-1, 18-13-1, 18-14-1, 18-17-1, 18-19-1	
---	--

IFF1E003



- Bandeja de foam 1/3 con llaves fijas
- 10 piezas

			€
IFF1E003	1	445 x 181 x 40	61,73

10-0607-1, 10-0809-1, 10-1011-1, 10-1213-1, 10-1415-1, 10-1617-1, 10-1819-1, 10-2022-1, 10-2427-1, 10-3032-1	
---	--

IFF1E004



- Bandeja de foam 1/3 con llaves combinadas
- 16 piezas

			€
IFF1E004	1	445 x 181 x 40	81,40

25-06-2, 25-07-2, 25-08-2, 25-09-2, 25-10-2, 25-11-2, 25-12-2, 25-13-2, 25-14-2, 25-15-2, 25-16-2, 25-17-2, 25-18-2, 25-19-2, 25-21-2, 25-22-2	
---	--

IFF1E005



- Bandeja de foam 1/3 con llaves de pipa abiertas hexagonales
- 11 piezas

			€
IFF1E005	1	445 x 181 x 40	157,42

52-08-1, 52-10-1, 52-11-1, 52-12-1, 52-13-1, 52-14-1, 52-15-1, 52-16-1, 52-17-1, 52-18-1, 52-19-1	
---	--

IFF1E006

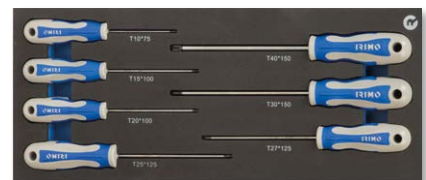

- Bandeja de foam 1/3 con destornilladores TORX®
- 7 piezas

			€
IFF1E006	1	445 x 181 x 40	49,42

414-10-75, 414-15-100, 414-20-100, 414-25-125, 414-27-125, 414-30-150, 414-40-150	
--	--



IFF1E007



- Bandeja de foam 1/3 con destornilladores rectos y planos
- 7 piezas

Q	Icon	Icon	€
IFF1E007	1	445 x 181 x 40	42,33

408-3-75, 408-3-5-100, 408-4-100, 408-5-5-125, 408-6-5-150	
407-8-150	
408-5.5-25	

IFF1E008

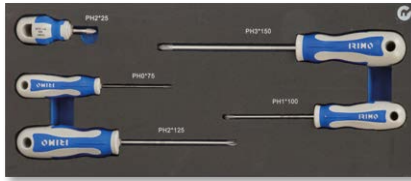

- Bandeja de foam 1/3 con destornilladores Phillips
- 5 piezas

Q	Icon	Icon	€
IFF1E008	1	445 x 181 x 40	35,87

409-0-75, 409-1-100, 409-2-125, 409-3-150	
409-2-25	

IFF1E009

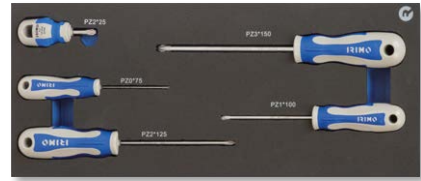

- Bandeja de foam 1/3" con destornilladores stubby y Pozidriv
- 5 piezas

Q	Icon	Icon	€
IFF1E009	1	445 x 181 x 40	36,65

413-0-75, 413-1-100, 413-2-125, 413-3-150	
413-2-25	

IFF1E010

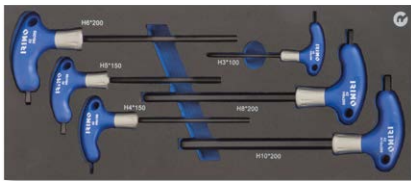

- Bandeja de foam 1/3 con destornilladores mango en "T" hexagonales
- 6 piezas

Q	Icon	Icon	€
IFF1E010	1	445 x 181 x 40	71,40

42-H3-100, 42-H4-150, 42-H5-150, 42-H6-200, 42-H8-200, 42-H10-200	
---	--

IFF1E011

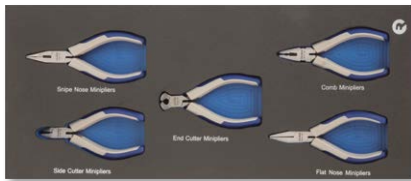

- Bandeja de foam 1/3 con mini alicates
- 5 piezas

Q	Icon	Icon	€
IFF1E011	1	445 x 181 x 40	63,78

601M-125-1	
612M-125-1	
624M-125-1	
626M-125-1	
604M-125-1	

IFF1E012

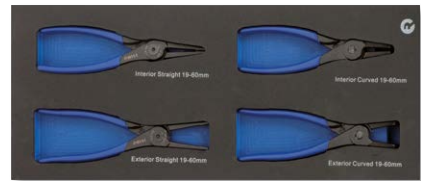

- Bandeja de foam de 1/3 con alicates para arandelas
- 4 piezas

Q	Icon	Icon	€
IFF1E012	1	445 x 181 x 40	94,19

621571	
621671	
621771	
621871	

2



3



4



5



6



7



8



9



10



11



12





BANDEJAS DE FOAM 1/3 PARA CARROS DE 26"

IFF1E013

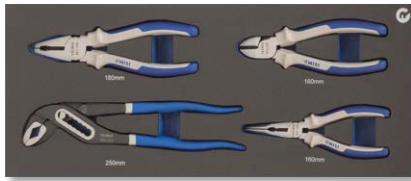

- Bandeja de foam 1/3 con alicates
- 4 piezas

€	Icon	Icon	Icon	€
IFF1E013	1	445 x 181 x 40		58,34

601-180-1	
624-160-1	
612-160-1	
634-250-1	

IFF1E014

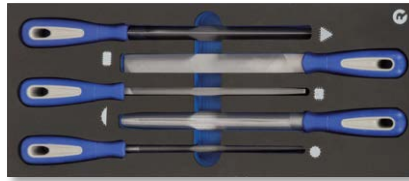

- Bandeja de foam 1/3 con limas
- 5 piezas

€	Icon	Icon	Icon	€
IFF1E014	1	445 x 181 x 40		59,02

534411	
534351	
534321	
534291	
534381	

IFF1E015



- Bandeja de foam 1/3 con vasos, carraca y extensiones de 1/2"
- 21 piezas

€	Icon	Icon	Icon	€
IFF1E015	1	445 x 181 x 40		145,30

121-10-1, 121-11-1, 121-12-1, 121-13-1, 121-14-1, 121-15-1, 121-16-1, 121-17-1, 121-18-1, 121-19-1, 121-21-1, 121-22-1, 121-23-1, 121-24-1, 121-27-1, 121-30-1, 121-32-1	
125-70-1	
125-42-1	
125-23-1	
125-25-1	

IFF1E016



- Bandeja de foam 1/3 con vasos y accesorios 1/4"
- 18 piezas

€	Icon	Icon	Icon	€
IFF1E016	1	445 x 181 x 40		91,47

101-04-1, 101-045-1, 101-05-1, 101-055-1, 101-06-1, 101-07-1, 101-08-1, 101-09-1, 101-10-1, 101-11-1, 101-12-1, 101-13-1, 101-14-1	
105-70-1	
105-42-1	
105-50-1	
105-22-1	
105-24-1	

IFF1E017

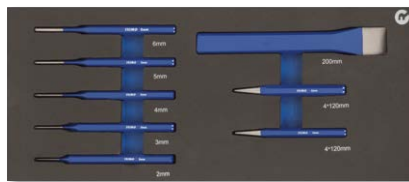

- Bandeja de foam 1/3 con cinceles y cortafíos
- 8 piezas

€	Icon	Icon	Icon	€
IFF1E017	1	445 x 181 x 40		52,91

504-200-1	
516-002-1, 516-003-1, 516-004-1, 516-005-1, 516-006-1	
512-010-1, 512-012-1	

IFF1E018



- Bandeja de foam 1/3 con herramienta de golpeo y corte
- 4 piezas

€	Icon	Icon	Icon	€
IFF1E018	1	445 x 181 x 40		49,54

529171	
527-51-2	
982-TOR-1	
668-150-1	



IFF1E019



- Bandeja de foam 1/3 con juego puntas, flexómetro, llaves hexagonales y linterna
- 72 piezas

Q	Icon	Icon	Icon	€
IFF1E019	1	445 x 181 x 40		62,48

475-61-1		
48-9-H		
980-3-1		
L14		

IFF1E024

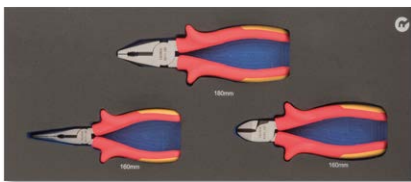

- Bandeja de foam 1/3 con alicates y cortante aislados
- 3 piezas

Q	Icon	Icon	Icon	€
IFF1E024	1	445 x 181 x 40		67,57

601V-180-1	
612V-160-1	
624V-160-1	

IFF1E021



- Bandeja de foam 1/3 con extractores
- 8 piezas

Q	Icon	Icon	Icon	€
IFF1E021	1	445 x 181 x 40		153,75

701-90-1	
702-40-1	
703-40-1	
716-5-1	

IFF1E025



- Bandeja de foam con destornilladores aislados
- 6 piezas

Q	Icon	Icon	Icon	€
IFF1E025	1	445 x 181 x 40		46,34

408V-3-100, 408V-4-100, 408V-5.5-125, 408V-6.5-150	
409V-1-150, 409V-2-175	

IFF1E023



- Bandeja de foam con llave ajustable y tenaza ajuste rápido
- 2 piezas

Q	Icon	Icon	Icon	€
IFF1E023	1	445 x 181 x 40		44,76

5-250C-1	
634Q-250-1	

2



3



4



5



6



7



8



9



10



11



12





CARROS

CARRO SOPORTE CON CAJAS APILABLES SOBRE RUEDAS



- Los múltiples compartimentos permiten almacenar de manera ordenada las herramientas para evitar pérdidas de tiempo
- Combinación de acero (proporcionando robustez) y polipropileno (ligereza)
- Apoyado en una base de ruedas y mango telescópico, que facilita el transporte aún cuando está muy cargado
- Ruedas goma: 125 x 35 mm
- Incluye candado para bloquear toda la torre
- Los 3 compartimentos se apilan gracias a sus pestañas metálicas laterales
- **Caja superior:** 485 x 225 x 210 mm
Se puede utilizar como caja independiente y se puede cerrar con el candado por separado
Asa grande de aluminio que permite un transporte fácil
Asas retraíbles laterales integradas que ayudan a levantar cuando la carga es elevada
Bandeja incluida 450 x 185 x 45 mm
- **Caja intermedia:** 390 x 215 x 60 mm
2 Cajones con sistema de rodamientos y apertura total
Se puede utilizar como caja independiente y se puede cerrar con el candado por separado
Asas retraíbles laterales integradas que ayudan a levantar cuando la carga es elevada
- **Compartimento inferior integrado:** 403 x 200 x 265 mm
Cajón de amplias dimensiones para alojar herramienta de mayor tamaño y accesorios
- Asa telescópica que conforma la estructura del carro en cuatro posiciones:
645 mm, 800 mm, 900 mm, 995 mm

R	Icono	mm	kg	€
9021FTW520	1	520 x 320 x 720	15	250,09

REPUESTOS

			€
9021FTW520-AC1	2 ruedas y husillo	125 x 35 mm	10,43
9021FTW520-AC2	Cierre para torre		3,72
9021FTW520-AC3	Torre con 4 cierres		8,14
9021FTW520-AC4	Mango telescópico		25,26
9021FTW520-AC5	Asa de aluminio caja superior		9,47

TORRE 3 CAJONES CON RUEDAS, 98 piezas



R	Icono	mm	kg	€
9021FTW520FF1	1	520 x 320 x 720	22.5	549,45

101-04-1, 101-045-1, 101-05-1, 101-055-1, 101-06-1, 101-07-1, 101-08-1, 101-09-1, 101-10-1, 101-11-1, 101-12-1, 101-13-1, 101-14-1	1/4"	
--	------	--

121-08-1, 121-10-1, 121-11-1, 121-12-1, 121-13-1, 121-14-1, 121-16-1, 121-17-1, 121-19-1, 121-21-1, 121-22-1	1/2"	
--	------	--

105-70-1		475-1/4-125	
----------	--	-------------	--

105-40-1		105-50-1	
----------	--	----------	--

105-22-1		105-24-1	
----------	--	----------	--

105-42-1		125-70-1	
----------	--	----------	--

125-40-1		125-43-1	
----------	--	----------	--

125-23-1		125-25-1	
----------	--	----------	--

46-8-F		475-32-1	
--------	--	----------	--

980-3B-1			
----------	--	--	--

407-5.5-125		409-1-100	
-------------	--	-----------	--

407-6.5-150		409-2-125	
-------------	--	-----------	--

612-160-1		601-180-1	
-----------	--	-----------	--

625-180-1		604-160-1	
-----------	--	-----------	--

5-250C-1		522-31-2	
----------	--	----------	--

634-250-1		665-200-1	
-----------	--	-----------	--

25-08-1, 25-09-1, 25-10-1, 25-11-1, 25-12-1, 25-13-1, 25-14-1, 25-17-1, 25-19-1			
---	--	--	--

9021FTW520			
------------	--	--	--

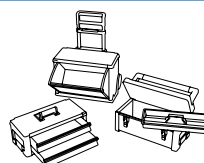

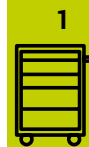

CARRO DOS BANDEJAS



- Fabricado y diseñado para un montaje muy fácil y rápido
- Dos estructuras en U de Aluminio
- Ruedas giratorias de 100 x 25 mm con rodamientos de bola y superficie de TPR que no marca: 2 fijas / 2 giratorias con freno
- Dimensiones de las bandejas: (2x) 750 x 425 x 77 mm

Artículo	Cant.	Longitud (mm)	Anchura (mm)	Alto (mm)	Alto (mm)	Alto (mm)	Peso (kg)	Peso (kg)	Peso (kg)	€		
9064K-02	1	759	432	1.025	300	759	432	x h	50	25 x 100	19	173,25
9064K-02T	1					757	425	x 77	50		3,25	47,62

TRANSPORTADORES

TRANSPORTADOR 90 KG



- Robusto
- Bandas elásticas para asegurar la carga
- Estructura de acero
- Base de aluminio, 250 x 450 mm
- Ruedas 170 mm
- Medidas: 480 x 420 x 740-100 mm
- Peso: 4,3 kg

Artículo	Cant.	Longitud (mm)	Anchura (mm)	Alto (mm)	Alto (mm)	Peso (kg)	€
9063FT90	1	250	450	90	170	4,3	75,78

TRANSPORTADOR



- Estructura de acero robusto
- Ruedas: 2 fijas y 2 giratorias para un fácil manejo
- Mango plegable para fácil almacenamiento y transporte
- Plataforma antideslizante
- Medidas transportador 150 kg:
 - Plegado: 730 x 470 x 225 mm
 - Sin plegar: 730 x 470 x 820 mm
- Medidas transportador 300 kg:
 - Plegado: 920 x 620 x 300 mm
 - Sin plegar: 920 x 620 x 870 mm

Artículo	Cant.	Longitud (mm)	Anchura (mm)	Alto (mm)	Alto (mm)	Peso (kg)	€
9063HT150	1	730	470	150	25 x 100	7,5	63,15
9063HT300	1	920	620	300	25 x 125	15,0	94,74



REPUESTOS

Artículo	Descripción	Artículo	Longitud (mm)	Anchura (mm)	Alto (mm)	Peso (kg)	€
9063HT150FI	(2x) ruedas fijas de 4"	9063TH150	130	100	30	0,30	8,24
9063HT150SW	(2x) ruedas giratorias de 4"	9063TH150	130	100	30	0,35	9,27
9063HT300FI	(2x) ruedas fijas de 5"	9063TH300	157	125	37	0,80	12,36
9063HT300SW	(2x) ruedas giratorias de 5"	9063TH300	157	125	37	0,90	14,32





BANCOS DE TRABAJO

BANCO DE TRABAJO DE ACERO RESISTENTE CON 4 PATAS



NOVEDAD

- Robusto banco de trabajo metálico
- 4 patas regulables en altura
- Patas con base roscada y goma antideslizante
- 4 ruedas opcionales (9062-CAST-1)
- Dos cajones con llave de bloqueo
- Igual grosor de chapa en la bandeja superior e inferior: 2 mm
- Pintura resistente antiarañazos
- Capacidad de carga máxima 500 kgs en la parte superior y 200 kgs en la bandeja inferior



R				kg	€
9062-1500-1	1	1500 x 640 x 865	500	56.9	513,97
9062-1800-1	1	1800 x 640 x 865	500	68.2	561,35

PANEL DE HERRAMIENTAS CON MARCO REFORZADO

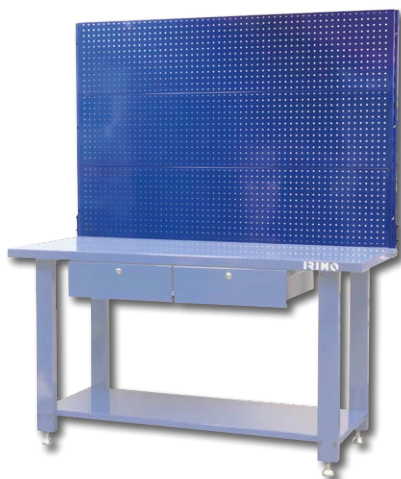

- Paneles metálicos con marco reforzado para bancos de trabajo 9062
- Agujeros estándar redondeados diam. 5 mm
- 2,5 mm de distancia entre agujeros
- Compuesto por tres planchas metálicas con dos postes de soporte
- Posibilidad de fijarlas a la pared si no se necesita el banco de trabajo
- Posibilidad de fijarlas al banco de trabajo con dos piezas de fijación (9062-FIX-1)

R			kg	€
9062-P1500-1	1	1500 x 990	14.7	110,00
9062-P1800-1	1	1800 x 990	17.6	130,00

KIT DE GANCHOS PARA ARMARIO Y PANEL 9062



- Kit de tres ganchos diferentes para paneles de agujeros redondeados

R		g	€
9062-HOOK-1	1	300	20,60

PACK DE 4 RUEDAS PARA BANCO DE TRABAJO



- Rueda 2 en 1 para bancos de trabajo 9062
- Convertible en patas fijas moviendo la rueda roja y el taco de goma bajará hasta dejarla fija
- La sencilla inserción del espárrago roscado en la pata facilitará el proceso para tener dos opciones para el banco de trabajo

R			kg	€
9062-CAST-1	1	140 x 202 x 90	2.6	55,00

ADAPTADORES DE PANELES DE HERRAMIENTAS

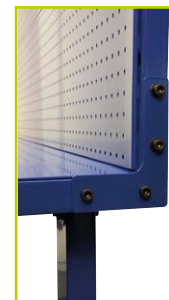
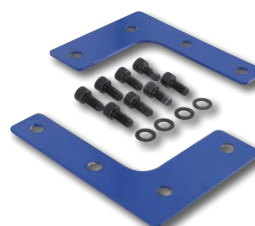

- Dos escuadras con pernos para fijar el panel al banco de trabajo 9062

R		g	€
9062-FIX-1	1	320	15,00





BANCO DE TRABAJO PLEGABLE



- Banco de trabajo plegable que soporta hasta 160 kg de peso
- Muy compacto: se pliega para facilitar su transporte y almacenamiento
- Los pasadores de pivote ajustables y las ranuras de retención de la mordaza brindan versatilidad de sujeción y retención segura del material
- Las manivelas de sujeción doble aumentan la fuerza de sujeción y la versatilidad
- Bases de las patas de goma antideslizantes
- Estructura de acero resistente
- Especialmente diseñado para una fácil instalación y limpieza
- Tamaño plegado: 150 x 610 x 900 mm

🔍	📦	📏	📏	📏	📊	€
9062FWB160	1	760 x 610 x 605	160	7.2	71,59	

2



3



4



5



CAJAS METÁLICAS

CON DOS ASAS



902021 / 902031



902131

- Caja porta herramientas con asas tubulares fijas que facilita la apertura y su transporte cuando está muy cargada
- Divisores en bandejas superiores para almacenar objetos pequeños
- El sistema de cierre bisagra impide la entrada de suciedad en la caja
- La caja se puede bloquear utilizando los agujeros de las tapas y el candado
- Todas las esquinas están redondeadas para evitar dañar al usuario
- Fabricada en chapa metálica tratada, de gran durabilidad

🔍	📦	📏	📏	📏	📊	€
902021	1	400 x 210 x 190	3	8	3.4	42,61
902031	1	500 x 210 x 190	3	10	4.1	46,32
902131	1	500 x 210 x 245	5	12	5.4	59,02

6



7



8



9



10



11



12





CAJAS METÁLICAS

CAJA RÍGIDA DE ALUMINIO, 97 piezas



R	📦	📏	kg	€
9024-1TS1	1	460 x 115 x 365	8.8	368,82
101-04-1, 101-045-1, 101-05-1, 101-055-1, 101-06-1, 101-07-1, 101-08-1, 101-09-1, 101-10-1, 101-11-1, 101-12-1, 101-13-1, 101-14-1				
121-08-1, 121-10-1, 121-11-1, 121-12-1, 121-13-1, 121-14-1, 121-16-1, 121-17-1, 121-19-1, 121-21-1, 121-22-1				
25-08-2, 25-09-2, 25-10-2, 25-11-2, 25-12-2, 25-13-2, 25-14-2, 25-17-2, 25-19-12				
407-5.5-125		409-1-100		358,08
407-6.5-150		409-2-125		
105-70-1		105-50-1		
105-40-1		105-42-1		
105-22-1		105-24-1		
125-70-1		125-40-1		
125-23-1		125-25-1		
125-43-1				
46-8-F		475-32-1		
5-250C-1		604-160-1		
612-160-1		601-180-1		
625-180-1		634-250-1		
522-31-2		665-200-1		
980-3B-1				

CAJA RÍGIDA DE ALUMINIO, 145 piezas



R	📦	📏	kg	€
9024-1TS145	1	450 x 115 x 290	12.5	489,21
101-04-1, 101-045-1, 101-05-1, 101-055-1, 101-06-1, 101-07-1, 101-08-1, 101-09-1, 101-10-1, 101-11-1, 101-12-1, 101-13-1, 101-14-1				
121-08-1, 121-10-1, 121-11-1, 121-12-1, 121-13-1, 121-14-1, 121-15-1, 121-16-1, 121-17-1, 121-18-1, 121-19-1, 121-21-1, 121-22-1, 121-24-1, 121-27-1, 121-30-1, 121-32-1				
25-08-2, 25-09-2, 25-10-2, 25-11-2, 25-12-2, 25-13-2, 25-14-2, 25-15-2, 25-16-2, 25-17-2, 25-18-2, 25-19-2				
105-70-1		105-50-1		
105-22-1		105-24-1		
105-40-1		105-42-1		
105-48-1		5-250C-1		
125-23-1		125-25-1		
125-70-1		125-40-1		
125-43-1		125-53-1, 125-54-1		
46-8-F		475-61-1		
801-041-1		980-5-1		
666-156-1		665-200-1		
520-43-2		L-ALUM-1		
634-250-1		632-220-1		
624-160-1		601-180-1		
612-160-1		604-160-1		
984-6D-1		475-5-1		





CAJA DE HERRAMIENTAS DE PLÁSTICO, 48 piezas



€	📦	📦	kg	€	
9023PT565TS1	1	170 x 565 x 302	10	295,83	
408V-3-100	⓪		408V-4-100	⓪	
408V-5.5-125	⓪		408V-6.5-150	⓪	
409V-1-150	⊕		409V-2-175	⊕	
601V-180-1			612V-160-1		
624V-160-1			629V-160-1		
634V-250-1			429-03-1		
5-200C-1			661051		
801-145-1			666-156-1		
980-3-1			475-32-1		
9023PT565					

CAJA DE HERRAMIENTAS DE PLÁSTICO



- Caja de plástico para herramientas con dos niveles
- Parte superior: 18 compartimentos para almacenar pequeñas piezas
- Resistente tapa transparente
- Con sistema de bloqueo con dos cierres metálicos
- Asa de acero tubular con empuñadura de plástico para mayor confort y fácil transporte

€	📦	📦	kg	€
9023PT565	1	170 x 565 x 320	2.4	65,74

2



3



4



5



6



7



8



9



10



11



12





BOLSAS DE TRANSPORTE DE HERRAMIENTA

BOLSA PORTA-HERRAMIENTAS ABIERTA



- Bolsa porta herramientas de fácil transporte y accesibilidad
- Fondo flexible reforzado en plástico duro
- 11 bolsillos verticales para una buena organización
- Mango de aluminio que refuerza toda la estructura con asa de foam para un mejor agarre
- Cinta para colgar del hombro ajustable en altura
- Fibra 600 x 300 que le proporciona resistencia y durabilidad
- Se entrega plegada

€	Icono	mm	kg	kg	€	
9022-1-16SB	1	440 x 210 x 310	21	15	1.5	27,25

BOLSA PORTA-HERRAMIENTAS ABIERTA



- Bolsa porta herramientas de fácil transporte y accesibilidad
- Base reforzada resistente al agua
- 12 bolsillos verticales en el lateral interiores y exteriores para una buena organización de la herramienta
- Panel interno despegable con 10 bolsillos y gomas para sujeción de la herramienta
- Velcro específico para el transporte de niveles y/o barras
- Mango de aluminio que refuerza toda la estructura con asa de foam para un mejor agarre
- Cinta para colgar del hombro ajustable en altura
- Fibra 600 x 300 que le proporciona resistencia y durabilidad
- Se entrega plegada

€	Icono	mm	kg	kg	€	
9022-1-19HB	1	490 x 240 x 350	32	20	1.5	65,71

BOLSA PORTA-HERRAMIENTAS CERRADA



- Bolsa con cremallera porta herramientas de fácil transporte y accesibilidad
- Base reforzada resistente al agua
- 10 bolsillos exteriores de diversos tamaños, algunos con tapa protectora y con clip para colocar flexómetros
- 14 bolsillos interiores para una mejor organización de la herramienta
- Cinta para el hombro ajustable para facilitar su transporte
- Fibra 600 x 300 que le proporciona resistencia y durabilidad

€	Icono	mm	kg	kg	€	
9022-2-16HB	1	420 x 240 x 300	24	18	1.2	32,12

BOLSA PORTA-HERRAMIENTAS CERRADA



- Bolsa con cremallera porta herramientas de fácil transporte y accesibilidad
- Base reforzada resistente al agua
- 17 bolsillos exteriores de diversos tamaños, algunos con tapa protectora y con clip para colocar flexómetros
- 14 bolsillos interiores para una mejor organización de la herramienta
- Cinta para el hombro ajustable para facilitar su transporte
- Fibra 600 x 300 que le proporciona resistencia y durabilidad

€	Icono	mm	kg	kg	€	
9022-2-19HB	1	490 x 240 x 370	35	20	1.5	38,66



MOCHILA PORTA HERRAMIENTAS



* La mochila viene sin herramientas



- Alta capacidad de almacenaje con diferentes bolsillos y organizador de herramientas desmontable. 20 L, 16 kg
- Compartimento para portátil
- Organizador desmontable: 10 bolsillos para una mejor organización
- Bolsillo para smartphone en el compartimento frontal
- Poliéster 600D. Resistente y duradera

Q	U	D	L	C	P	P	€
9022-BP1	1	300 x 450 x 175	20	16	1.93		60,85

MOCHILA PORTA HERRAMIENTAS CON RUEDAS



* La mochila viene sin herramientas



- Mango telescópico y 2 ruedas fijas para un fácil transporte
- Alta capacidad de almacenaje con diferentes bolsillos y organizador de herramientas desmontable. 26 L, 20 kg
- Compartimento para portátil
- Organizador desmontable con 2 asas: 51 bolsillos para una mejor organización
- Poliéster 600D. Resistente y duradera
- Dos soportes delanteros para estabilizar el peso

Q	U	D	L	C	P	P	€
9022-BPW	1	360 x 440 x 220	26	20	4		102,28

PORTAHERRAMIENTAS Y MALETINES

ESTUCHE PORTA HERRAMIENTAS



- Gomas elásticas en base y tapa para una mejor distribución de las herramientas
- Doble cremallera
- Asa de goma suave
- Compartimento para documentación
- Medidas: 258 x 55 x 258 mm

Q	U	D	P	€
9022-4-26	1	258 x 55 x 258	810	15,15

ESTUCHE PORTA HERRAMIENTAS



- Gomas elásticas en base y tapa para una mejor distribución de las herramientas
- Doble cremallera
- Asa de goma suave
- Compartimento para documentación
- Medidas: 353 x 50 x 310 mm

Q	U	D	P	€
9022-4-35	1	353 x 50 x 310	810	20,21

2



3



4



5



6



7



8



9



10



11



12





PORTAHERRAMIENTAS Y MALETINES

JUEGO DE 18 HERRAMIENTAS EN ESTUCHE



R	Icon	Icon	kg	€
9022-4-26TS1	1	258 x 55 x 258	1.5	63,15
475R-1/4-110		5-200C-1		
624-140-1		601-160-1		
982-TOR-1		980-3-1		
9022-4-26				

JUEGO 28 HERRAMIENTAS EN ESTUCHE



R	Icon	Icon	kg	€
9022-4-35TS1	1	353 x 50 x 310	3	119,99
475R-1/4-110		46-9-H		
5-200C-1		624-160-1		
601-160-1		520-43-2		
668-150-1		980-5-1		
9022-4-35				

PORTA MARTILLOS



R	Icon	Icon	g	€
9022-3-20	1	170 x 70 x 120	120	10,32

MARTILLO CON SOPORTE PARA CINTURÓN



R	Icon	g	€
9022-3-20TS1	1	790	21,92

9022-3-20		520-43-2	
-----------	--	----------	--

MARTILLO CON SOPORTE PARA CINTURÓN



R	Icon	g	€
9022-3-20TS2	1	790	25,79

9022-3-20		520-41-2	
-----------	--	----------	--





BOLSA PARA ALICATE



R	Icon	mm	g	€
9022-3-30	1	260 x 95	40	9,03

SET CON 4 HERRAMIENTAS PARA ELECTRICISTA CON ALICATE UNIVERSAL



R	Icon	mm	g	€	
9022-3-30TS1	1	260 x 95 x 30	580	36,10	
407-4-100	①		409-1-100	⊕	
601-180-1		668-150-1			
9022-3-30					

SET CON 4 HERRAMIENTAS PARA ELECTRICISTA



R	Icon	mm	g	€	
9022-3-30TS2	1	260 x 95 x 30	550	37,40	
407-4-100	①		409-1-100	⊕	
624-160-1		668-150-1			
9022-3-30					

BOLSA DE HERRAMIENTAS



R	Icon	mm	g	€
9022-3-40	1	290 x 10 x 150	60	14,18

BOLSA CON 7 HERRAMIENTAS PARA MANTENIMIENTO GENERAL



R	Icon	mm	g	€	
9022-3-40TS1	1	290 x 60 x 150	1000	65,77	
407-6.5-150	①		409-2-125	⊕	
624-140-1		601-160-1			
665-200-1		5-150C-1			
9022-3-40		980-3-1			

BOLSA CON 7 HERRAMIENTAS DE SEGURIDAD



R	Icon	mm	g	€	
9022-3-40TS2	1	290 x 60 x 150	1000	83,82	
408V-4-100	①		409V-1-150	⊕	
624V-160-1		612V-160-1			
665-200-1		5-150C-1			
9022-3-40		980-3-1			

2



3



4



5



6



7



8



9



10



11



12





PORTAHERRAMIENTAS Y MALETINES

BOLSA CON 10 COMPARTIMENTOS



€				€
9022-3-50	1	260 x 70 x 355	480	24,51

CINTURÓN AJUSTABLE



€				€
9022-3-10	1	1500 x 10 x 75	200	11,60

BOLSA CON 9 HERRAMIENTAS PARA MANTENIMIENTO GENERAL



€				€
9022-3-50TS1	1	260 x 95 x 355	2400	88,96

407-5.5-125		409-1-100	
407-6.5-150		409-2-125	
520-43-2		634-250-1	
624-160-1		982-TOR-1	
9022-3-50		980-5-1	



A full-page photograph of a male mechanic with a beard, wearing a blue work uniform, looking upwards while working on a car engine. He is holding a silver adjustable wrench in his left hand. The background is dark and industrial, with a blurred car part visible in the lower left. A yellow, textured horizontal band is overlaid across the middle of the image.

02. LLAVES



LLAVES AJUSTABLES INGLESAS

MOLETA LATERAL

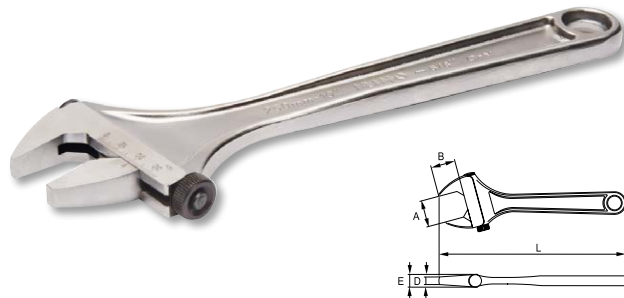

- Material: CrV; Acabado: Mate
- Dureza: 40-45 HRc
- Ángulo de cabeza 15° que proporciona mayor accesibilidad en espacios confinados
- UNE 16532, ISO 6787, DIN 3117

R	Envase	Longitud	A mm	B mm	D mm	E mm	L mm	g	€
001021	5	150 mm - 6"	21	18.5	6.5	12	155	140	27,40
001031	5	200 mm - 8"	29	26	8	14	205	290	31,24
001041	5	250 mm - 10"	34	32	9	17	255	510	37,07
001051	3	300 mm - 12"	39	36	10	20	305	795	47,37
001061	1	400 mm - 16"	49	44	14	26	405	1.620	79,28
001071	1	500 mm - 20"	62	53	17	30	500	2.860	150,69
001081	1	750 mm - 30"	78	70	23	37	750	5.550	294,45

MOLETA CENTRAL

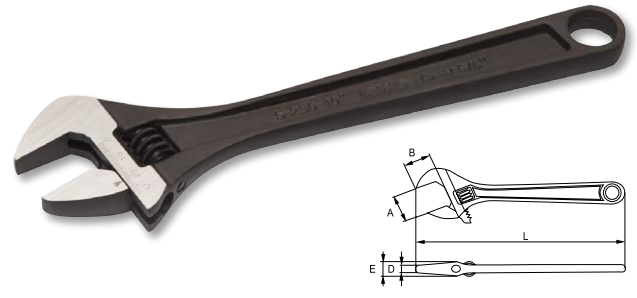

- Material: CrV; Acabado: Fosfatada
- Dureza: 40-45 HRc
- Ángulo de cabeza 15° que proporciona mayor accesibilidad en espacios confinados
- UNE 16532, ISO 6787, DIN 3117
- -1 Envase individual
- -2 Envase industrial

R	Envase	Longitud	A mm	B mm	D mm	E mm	L mm	g	€
5-100-1	5	100 mm - 4"	13	13.5	3.5	9	115	60	11,34
5-150-1	5	150 mm - 6"	20	21	5.5	12	160	130	11,97
5-200-1	5	200 mm - 8"	24	26	7.5	13.5	205	250	13,77
5-250-1	5	250 mm - 10"	29	29.5	9	16	260	405	16,93
5-300-1	5	300 mm - 12"	36	36	11	19	310	650	22,31
5-100-2	60	100 mm - 4"	13	13.5	3.5	9	115	60	10,18
5-150-2	50	150 mm - 6"	20	21	5.5	12	160	130	11,35
5-200-2	40	200 mm - 8"	24	26	7.5	13.5	205	250	12,96
5-250-2	30	250 mm - 10"	29	29.5	9	16	260	405	16,21
5-300-2	20	300 mm - 12"	36	36	11	19	310	650	21,65
5-375-2	1	375 mm - 15"	43	45	13	24	385	1.230	43,97
5-450-2	1	450 mm - 18"	57	53	15	27.5	465	2.000	70,99

MOLETA CENTRAL



- Material: CrV; Acabado: Cromada
- Dureza: 40-45 HRc
- Ángulo de cabeza 15° que proporciona mayor accesibilidad en espacios confinados
- UNE 16532, ISO 6787, DIN 3117
- -1 Envase individual
- -2 Envase industrial

R	Envase	Longitud	A mm	B mm	D mm	E mm	L mm	g	€
5-100C-1	5	100 mm - 4"	13	13.5	3.5	9	115	60	9,03
5-150C-1	5	150 mm - 6"	20	21	5.5	12	160	130	9,47
5-200C-1	5	200 mm - 8"	24	26	7.5	13.5	205	250	10,89
5-250C-1	5	250 mm - 10"	29	29.5	9	16	260	405	13,25
5-300C-1	5	300 mm - 12"	36	36	11	19	310	650	17,54
5-375C-2	1	375 mm - 15"	43	45	13	24	385	1.230	34,45
5-450C-2	1	450 mm - 18"	57	53	15	27.5	465	2.000	57,48



JUEGO 4 LLAVES AJUSTABLES INGLESAS FOSFATADAS



- Material: CrV: Acabado: Fosfatada
- Dureza: 40-45 HRC
- Ángulo de cabeza 15° que proporciona mayor accesibilidad en espacios confinados
- UNE 16532, ISO 6787, DIN 3117

Q	📦	📏	📏	📏	g	€
5-4-W	1	4	50 x 330 x 110		1.500	72,20
5-150-2, 5-200-2, 5-250-2, 5-300-2						

LLAVES FIJAS

LLAVES FIJAS

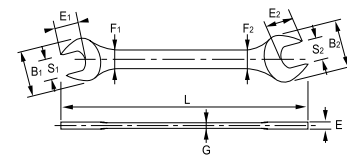

- Acero aleado de alto rendimiento cromado acabado mate
- Dureza: 42-50 HRC
- DIN 3110, ISO 10102, ISO 1085, ISO 1711, ISO 691, ISO 3318
- -1 Envase individual

Q	📦	S1 x S2 mm	L mm	B1 mm	B2 mm	F1 mm	F2 mm	E1 mm	E2 mm	E mm	G mm	g	€
10-0405-1	1	4 x 5	105	13	15	6.5	7.5	7.2	7	3.2	2.5	15	2,78
10-0607-1	1	6 x 7	122	17.4	19.4	7.5	8.5	8.1	9	4.1	2.8	21	2,78
10-0809-1	1	8 x 9	137	20.4	22.4	8.5	9.5	10.5	11.2	4.6	3.3	30	2,85
10-1011-1	1	10 x 11	151.4	24.2	27.2	10.5	11.5	11.6	13.3	5.4	3.8	46	3,08
10-1013-1	1	10 x 13	151.4	24.2	37.2	10.5	11.5	11.6	13.3	5.4	3.8	46	3,75
10-1213-1	1	12 x 13	166.5	29.4	31.4	12.5	13.5	13.6	15.3	6.1	4	66	3,77
10-1415-1	1	14 x 15	182	32.4	35.4	13.5	14.5	16	17.5	6.5	4.4	95	3,98
10-1617-1	1	16 x 17	196.5	36.4	38.4	15.5	16.5	18.5	19.6	6.9	4.8	124	4,61
10-1719-1	1	17 x 19	221	40.4	42.4	16.5	18.5	20.8	22.4	7.4	5.1	160	5,20
10-1819-1	1	18 x 19	211.9	40.4	42.4	16.5	18.5	20.8	21.2	7.4	5.1	157	5,20
10-2022-1	1	20 x 22	226.9	43.4	47.4	18.5	19.5	23.3	24.5	8.6	5.6	188	6,10
10-2123-1	1	21 x 23	241.9	46.4	50.4	18.5	20.5	23.6	26	9.2	5.8	211	6,66
10-2224-1	1	22 x 24	241.9	46.4	50.4	18.5	20.5	23.6	26	9.2	5.8	208	6,71
10-2426-1	1	24 x 26	261.9	50.4	54.4	21.5	23.5	27.9	29.8	10	6.2	293	8,23
10-2427-1	1	24 x 27	261.9	50.4	54.4	21.5	23.5	27.9	29.8	10	6.2	284	8,85
10-2528-1	1	25 x 28	281.9	54.4	59.4	23.5	24.5	28.6	30.7	10.6	6.6	366	11,24
10-2729-1	1	27 x 29	282.4	54.6	59.6	23.5	24.5	28.6	30.7	10.6	6.6	362	12,19
10-3032-1	1	30 x 32	302.9	61.4	68.4	24.5	26.5	33.4	35.5	11	7	481	13,40

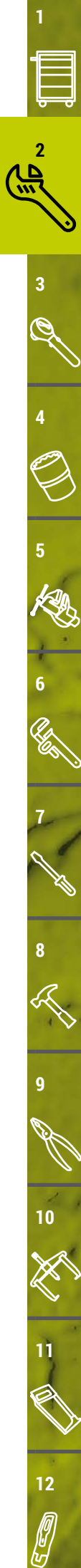



LLAVES FIJAS

JUEGO 8 LLAVES FIJAS



- Acero aleado de alto rendimiento cromado acabado mate
- Dureza: 42-50 HRc
- DIN 3110, ISO 10102, ISO 1085, ISO 1711, ISO 691, ISO 3318

€					€
10-8-H	1	8	250 x 120 x 50	870	32,64

10-0607-1, 10-0809-1, 10-1011-1, 10-1213-1, 10-1415-1, 10-1617-1, 10-1819-1, 10-2022-1

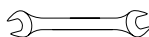

JUEGO 12 LLAVES FIJAS



- Acero aleado de alto rendimiento cromado acabado mate
- Dureza: 42-50 HRc
- DIN 3110, ISO 10102, ISO 1085, ISO 1711, ISO 691, ISO 3318

€					€
10-12-H	1	12	350 x 150 x 70	2.975	67,83

10-0607-1, 10-0809-1, 10-1011-1, 10-1213-1, 10-1415-1, 10-1617-1, 10-1819-1, 10-2022-1, 10-2123-1, 10-2426-1, 10-2528-1, 10-3032-1

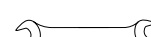

JUEGO 12 LLAVES FIJAS



- Acero aleado de alto rendimiento cromado acabado mate
- Dureza: 42-50 HRc
- DIN 3110, ISO 10102, ISO 1085, ISO 1711, ISO 691, ISO 3318

€					€
10-12-W	1	12	400 x 140 x 100	2.975	71,77

10-0607-1, 10-0809-1, 10-1011-1, 10-1213-1, 10-1415-1, 10-1617-1, 10-1819-1, 10-2022-1, 10-2123-1, 10-2426-1, 10-2528-1, 10-3032-1

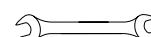



LLAVES COMBINADAS

LLAVES COMBINADAS EN MILÍMETROS

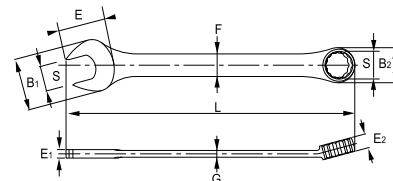

- Acero aleado de alto rendimiento cromado acabado mate
- Dureza: 42-50 HRc
- DIN 3113, ISO 1711-1, ISO 3318, ISO 691, ISO 7738
- -1 Envase individual
- -2 Envase industrial

Q	Icon	S mm	L mm	B1 mm	B2 mm	F mm	E mm	E1 mm	E2 mm	G mm	g	€
25-06-1	1	6	103	15.7	10.6	6.2	7.9	3.7	5.2	3	15	2,84
25-07-1	1	7	109	18	12.1	6.8	8.2	3.7	5.5	3	17	2,89
25-08-1	1	8	119	18.8	13.6	6.8	9.9	4.0	6	3.3	21	2,96
25-09-1	1	9	124	21	15.1	7.9	10.4	4.0	6.8	3.4	26	3,52
25-10-1	1	10	134	22.8	16.2	8.6	10.7	4.8	7	3.6	38	3,54
25-11-1	1	11	143	25.8	17.1	9.1	12.6	4.8	7.5	3.6	39	3,87
25-12-1	1	12	154	27.8	18.9	10	13.2	5.2	8	4.2	51	4,08
25-13-1	1	13	164	29.8	20.2	11.5	14.6	5.2	8.3	4.2	63	4,32
25-14-1	1	14	174	29.8	21.2	11.4	15.8	5.8	8.9	4.6	68	4,49
25-15-1	1	15	183	34.1	22.3	12.2	16.9	5.8	8.9	4.6	85	4,62
25-16-1	1	16	194	35.1	23.8	13.2	17.6	6.3	9.5	5	107	4,91
25-17-1	1	17	203	37.2	25.3	14.4	18.6	6.3	10	5	118	5,24
25-18-1	1	18	214	39.2	26.8	14.4	20.5	6.7	10.5	5.2	137	5,52
25-19-1	1	19	228	41.4	28.3	15.8	21.1	7.0	11.2	5.2	163	6,30
25-20-1	1	20	240	42.4	29.7	17.3	22.8	7.5	11.4	5.5	186	6,37
25-21-1	1	21	249.5	45.4	32.4	17.3	22.8	8.6	12.6	6	210	7,29
25-22-1	1	22	249.5	45.4	32.4	17.3	22.8	8.6	12.2	6	202	7,35
25-23-1	1	23	270	49.7	36.1	20.3	25	9.2	13.6	6.4	281	7,77
25-24-1	1	24	270	49.7	36.1	20.3	25	9.2	13.6	6.4	276	8,14
25-25-1	1	25	289.5	53.4	39.6	22.5	27.6	9.6	14.2	6.8	346	8,83
25-26-1	1	26	289.5	53.4	39.6	22.5	27.6	9.6	14.2	6.8	345	10,48
25-27-1	1	27	310	58.4	41.6	23.3	29.5	10.0	14.6	7.2	382	11,59
25-28-1	1	28	310	58.4	41.6	23.3	29.5	10.0	14.6	7.2	402	12,32
25-29-1	1	29	330	60.4	45.6	23.3	32.1	10.6	15.6	7.6	476	12,63
25-30-1	1	30	330	60.4	45.6	23.3	32.1	10.6	15.6	7.6	468	14,03
25-32-1	1	32	349	67.4	48.8	25.3	35.6	11.2	17.8	8	567	15,13
25-34-1	1	34	350	67.4	48.8	25.3	35.6	11.2	17.8	8	541	18,98

Q	Icon	S mm	L mm	B1 mm	B2 mm	F mm	E mm	E1 mm	E2 mm	G mm	g	€
25-06-2	1	6	103	15.7	10.6	6.2	7.9	3.7	5.2	3	15	2,84
25-07-2	1	7	109	18	12.1	6.8	8.2	3.7	5.5	3	17	2,89
25-08-2	1	8	119	18.8	13.6	6.8	9.9	4.0	6	3.3	21	2,96
25-09-2	1	9	124	21	15.1	7.9	10.4	4.0	6.8	3.4	26	3,52
25-10-2	1	10	134	22.8	16.2	8.6	10.7	4.8	7	3.6	38	3,54
25-11-2	1	11	143	25.8	17.1	9.1	12.6	4.8	7.5	3.6	39	3,87
25-12-2	1	12	154	27.8	18.9	10	13.2	5.2	8	4.2	51	4,08
25-13-2	1	13	164	29.8	20.2	11.5	14.6	5.2	8.3	4.2	63	3,85
25-14-2	1	14	174	29.8	21.2	11.4	15.8	5.8	8.9	4.6	68	3,99
25-15-2	1	15	183	34.1	22.3	12.2	16.9	5.8	8.9	4.6	85	4,15
25-16-2	1	16	194	35.1	23.8	13.2	17.6	6.3	9.5	5	107	4,42
25-17-2	1	17	203	37.2	25.3	14.4	18.6	6.3	10	5	118	4,77
25-18-2	1	18	214	39.2	26.8	14.4	20.5	6.7	10.5	5.2	137	5,04
25-19-2	1	19	228	41.4	28.3	15.8	21.1	7.0	11.2	5.2	163	5,83
25-20-2	1	20	240	42.4	29.7	17.3	22.8	7.5	11.4	5.5	186	5,89
25-21-2	1	21	249.5	45.4	32.4	17.3	22.8	8.6	12.6	6	210	6,81
25-22-2	1	22	249.5	45.4	32.4	17.3	22.8	8.6	12.2	6	202	6,88
25-23-2	1	23	270	49.7	36.1	20.3	25	9.2	13.6	6.4	281	7,30
25-24-2	1	24	270	49.7	36.1	20.3	25	9.2	13.6	6.4	276	7,67
25-25-2	1	25	289.5	53.4	39.6	22.5	27.6	9.6	14.2	6.8	346	8,33
25-26-2	1	26	289.5	53.4	39.6	22.5	27.6	9.6	14.2	6.8	345	10,01
25-27-2	1	27	310	58.4	41.6	23.3	29.5	10.0	14.6	7.2	382	11,09
25-28-2	1	28	310	58.4	41.6	23.3	29.5	10.0	14.6	7.2	402	11,83
25-29-2	1	29	330	60.4	45.6	23.3	32.1	10.6	15.6	7.6	476	12,14
25-30-2	1	30	330	60.4	45.6	23.3	32.1	10.6	15.6	7.6	468	13,55
25-32-2	1	32	349	67.4	48.8	25.3	35.6	11.2	17.8	8	567	14,66
25-34-2	1	34	350	67.4	48.8	25.3	35.6	11.2	17.8	8	541	18,51
25-36-2	1	36	401	74	54	31	62	10.4	17	8	787	28,28
25-41-2	1	41	436	82	61	34	70	12	19.5	8	1.070	39,64
25-46-2	1	46	556	92	66	33.6	79.8	15	23	11	1.750	51,17
25-50-2	1	50	602	100	73	36.6	86.7	17	26	12	2.200	59,53
25-55-2	1	55	612	113	84	42	94	18	28	14.5	3.070	133,98
25-60-2	1	60	660	125	90	47	100	20	30	16	3.500	177,90
25-65-2	1	65	710	132	98	52	110	21	34	18	4.750	237,05
25-70-2	1	70	760	140	102	52	110	22	35	18	5.550	281,87
25-75-2	1	75	810	150	108	55	120	25	38	19	6.800	355,35
25-80-2	1	80	820	179	131	60	120	30	38	20	10.000	480,21
25-85-2	1	85	820	179	131	60	120	30	38	20	10.000	598,78
25-90-2	1	90	790	179	131	60	120	30	38	20	10.000	598,78
25-95-2	1	95	860	187	145	62	120	32	43	20	12.000	598,78
25-100-2	1	100	860	187	145	62	120	32	43	20	12.000	741,07





JUEGO 12 LLAVES COMBINADAS



- Acero aleado de alto rendimiento cromado acabado mate
- Dureza: 42-50 HRC
- DIN 3113, ISO 1711-1, ISO 3318, ISO 691, ISO 7738

E		X		g	€
25-12-W	1	12	400 x 140 x 100	2.975	117,17
25-10-1, 25-11-1, 25-12-1, 25-13-1, 25-14-1, 25-17-1, 25-19-1, 25-22-1, 25-24-1, 25-27-1, 25-30-1, 25-32-1					

LLAVES COMBINADAS CON CARRACA

LLAVE COMBINADA CON CARRACA FIJA



- Acero aleado de alto rendimiento cromado acabado mate
- Dureza: 40-50 HRC
- -1 Envase individual

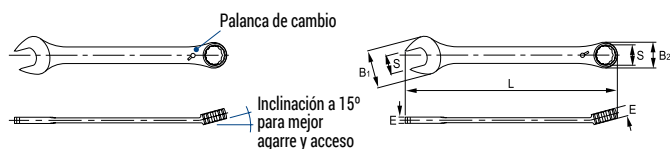

Carraca resistente sobrepasa ISO

E		S mm	B1 mm	B2 mm	E mm	L mm	g	€
18-06-1	1	6	15	14.3	4	128	27	7,55
18-07-1	1	7	16.4	16.8	4.4	138	35	7,55
18-08-1	1	8	18	18.3	4.8	140	38	7,55
18-09-1	1	9	20	20	4.8	150	48	7,73
18-10-1	1	10	22	21.5	5.1	160	57	7,73
18-11-1	1	11	24.5	23.5	5.5	165	67	8,18
18-12-1	1	12	26	25	5.9	170	82	8,56
18-13-1	1	13	28	26.4	6.4	180	95	9,62
18-14-1	1	14	30.8	28	6.7	190	113	10,32
18-15-1	1	15	33	30	7.3	200	130	10,76
18-16-1	1	16	24.5	31	7.8	210	158	11,77
18-17-1	1	17	37	33	8	225	180	12,58
18-18-1	1	18	39.5	35	8.2	235	213	13,21
18-19-1	1	19	40.8	36	8.4	245	233	13,77
18-21-1	1	21	44.8	42	9	290	343	16,67
18-22-1	1	22	44.8	42	9	290	345	18,22
18-24-1	1	24	52.8	48	9.7	332	503	20,73
18-27-1	1	27	56	53	10.8	359	550	27,25
18-30-1	1	30	62	58	11.2	404	750	32,16
18-32-1	1	32	65	62	12	424	900	41,47

JUEGO 8 LLAVES COMBINADAS CON CARRACA FIJA



- Acero aleado de alto rendimiento cromado acabado mate
- Dureza: 40-50 HRC

E		X		g	€
18-8-H	1	8	45 x 245 x 130	870	77,38
18-08-1, 18-10-1, 18-11-1, 18-12-1, 18-13-1, 18-14-1, 18-17-1, 18-19-1					

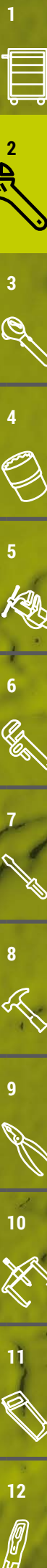



LLAVES COMBINADAS CON CARRACA

JUEGO 12 LLAVES COMBINADAS CON CARRACA FIJA



- Acero aleado de alto rendimiento cromado acabado mate
- Dureza: 40-50 HRc

Artículo	Paquete	Cantidad	Dimensiones	Peso	Precio
18-12-H	1	12	180 x 35 x 250	1.510	117,06
18-08-1, 18-09-1, 18-10-1, 18-11-1, 18-12-1, 18-13-1, 18-14-1, 18-15-1, 18-16-1, 18-17-1, 18-18-1, 18-19-1					

LLAVES COMBINADAS EXTRACORTAS CON CARRACA FIJA

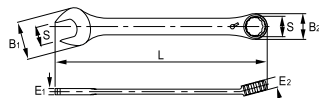

- Acero aleado de alto rendimiento cromado acabado mate
- Dureza: 40-50 HRc
- -1 Envase individual

Artículo	Paquete	S mm	B1 mm	B2 mm	E1 mm	E2 mm	L mm	Peso	Precio
18S-08-1	1	8	18	18.3	5.3	7.2	90	30	5,73
18S-10-1	1	10	22	22	6.0	7.8	96	48	5,90
18S-13-1	1	13	28	28	6.8	9.1	108	72	7,21
18S-17-1	1	17	37	37	8.1	10.5	128	125	9,33
18S-19-1	1	19	40.8	40.8	8.5	11.2	138	163	10,40

JUEGO 5 LLAVES COMBINADAS EXTRACORTAS CON CARRACA FIJA



- Acero aleado de alto rendimiento cromado acabado mate
- Dureza: 40-50 HRc

Artículo	Paquete	Cantidad	Dimensiones	Peso	Precio
18S-5-H	5	5	8-10-13-17-19 mm	462	38,60

JUEGO 5 LLAVES COMBINADAS DOBLES CON CARRACA FIJA



- Acero aleado de alto rendimiento cromado acabado mate
- Dureza: 40-50 HRc

Artículo	Paquete	Cantidad	Dimensiones	Peso	Precio
18D-5-H	5	5	8x9, 10x11, 12x13, 16x17, 18x19 mm	664	52,17



LLAVE COMBINADA CON CARRACA ARTICULADA

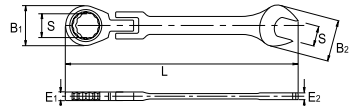

- Acero aleado de alto rendimiento cromado acabado mate
- Dureza: 40-50 HRc
- -1 Envase individual

R	Icono	S mm	B1 mm	B2 mm	E1 mm	E2 mm	L mm	g	€
19-08-1	1	8	18.3	18	7.2	4.8	140	35	9,62
19-10-1	1	10	21.5	22	7.8	5.1	160	55	9,88
19-11-1	1	11	23.5	24.5	8.4	5.5	165	63	10,39
19-12-1	1	12	25	26	8.8	5.9	170	83	10,82
19-13-1	1	13	26.4	28	9.1	6.4	180	93	12,21
19-14-1	1	14	28	30.8	9.4	6.7	190	113	13,21
19-17-1	1	17	33	37	10.5	8	225	173	15,98
19-19-1	1	19	36.5	40.8	11.2	8.4	245	233	17,49

JUEGO 8 LLAVES DE CARRACA CON CABEZA FLEXIBLE



- Acero aleado de alto rendimiento cromado acabado mate
- Dureza: 40-50 HRc

R	Icono	Icono X	Icono S	g	€
19-8-H	1	8	45 x 240 x 140	850	99,40
19-08-1, 19-10-1, 19-11-1, 19-12-1, 19-13-1, 19-14-1, 19-17-1, 19-19-1					

JUEGO 12 LLAVES DE CARRACA CON CABEZA FLEXIBLE



- Acero aleado de alto rendimiento cromado acabado mate
- Dureza: 40-50 HRc

R	Icono	Icono X	Icono S	g	€
19-12-H	1	12	35 x 180 x 250	1.724	144,31
19-08-1, 19-09-1, 19-10-1, 19-11-1, 19-12-1, 19-13-1, 19-14-1, 19-15-1, 19-16-1, 19-17-1, 19-18-1, 19-19-1					

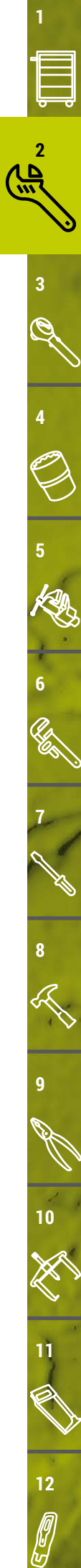
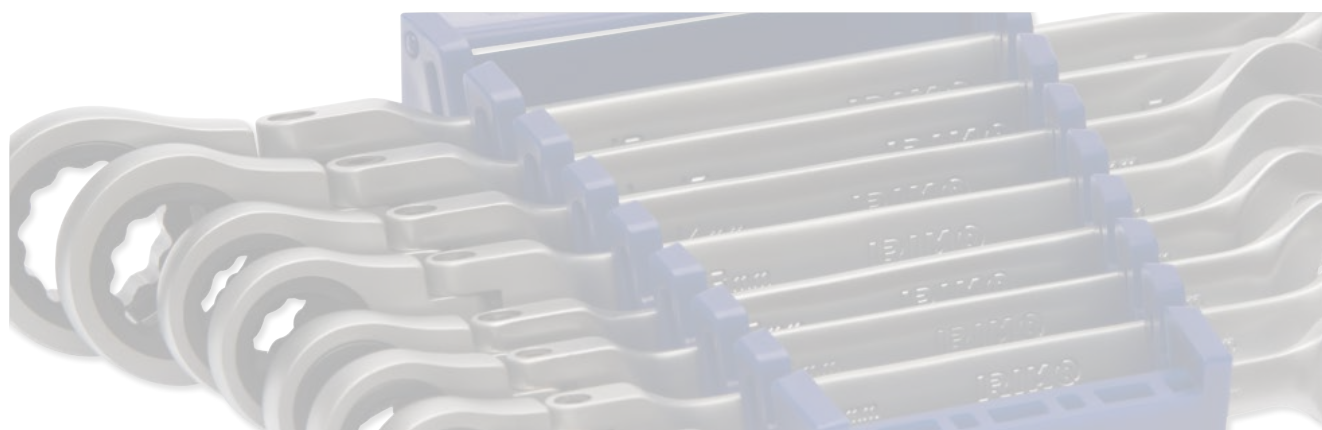



LLAVES DE ESTRELLA PLANA

LLAVE DE ESTRELLA

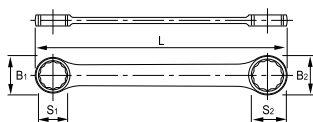

- Acero aleado de alto rendimiento cromado acabado mate
- Dureza: 42-48 HRc
- DIN 837, ISO 10103, ISO 1085

Q		S1 x S2 mm	B1 mm	B2 mm	E mm	L mm	g	€
020011	1	6x7	9.8	11	4.5	95	14	7,96
020031	1	8x9	12.5	14	5.5	110	22	8,23
020051	1	10x11	15	16.5	6	125	32	9,15
020071	1	12x13	18.5	20	6.5	140	46	9,99
020091	1	14x15	21	22.5	7	155	57	10,96
020121	1	16x17	24	25	7.5	170	73	11,78
020141	1	18x19	26.5	27.5	8	185	94	12,25
020171	1	20x22	29	32	9	205	125	14,14
020181	1	21x23	30	33	9.5	225	154	15,49
020201	1	24x26	35	37.8	11	250	210	17,38
020211	1	24x27	35	37.5	11	250	208	17,38
020221	1	25x28	37.5	41	11	275	280	19,64
020241	1	27x29	37.5	41	11	275	272	23,46
020251	1	30x32	43	45.5	12	300	367	24,76

JUEGO LLAVES DE ESTRELLA



- Acero aleado de alto rendimiento cromado acabado mate
- Dureza: 42-48 HRc
- DIN 837, ISO 10103, ISO 1085

Q				g	€
021221	1	8	6-7, 8-9, 10-11, 12-13, 14-15, 16-17, 18-19, 20-22 mm	500	91,45
021251	1	12	6-7, 8-9, 10-11, 12-13, 14-15, 16-17, 18-19, 20-22, 21-23, 24-27, 25-28, 30-32 mm	1.550	168,59



LLAVES DE ESTRELLA ACODADA

LLAVE DE ESTRELLA ACODADA



- Acero aleado de alto rendimiento cromado acabado mate
- Dureza: 42-48 HRc
- ISO 10104 y DIN 838
- -1 Envase individual
- -2 Envase industrial

E		S1 x S2	B1	B2	E1	E2	H	L	g	€
15-0607-1	1	6x7	10.8	12.5	4.9	5.6	20	170	45	5,55
15-0809-1	1	8x9	13.4	15.3	6.0	6.8	21	182	70	6,08
15-1011-1	1	10x11	16.0	17.8	7.4	7.9	23	197	90	6,45
15-1213-1	1	12x13	18.8	20.2	8.4	8.9	25	213	126	6,93
15-1415-1	1	14x15	20.8	22.5	9.4	9.9	26	228	155	7,34
15-1617-1	1	16x17	24.2	25.7	10.4	10.9	29	246	193	8,76
15-1719-1	1	17x19	27.6	28.7	11.4	11.9	31	265	243	10,22
15-1819-1	1	18x19	27.6	28.7	11.4	11.9	31	265	241	10,22
15-2022-1	1	20x22	29.7	32.5	12.4	12.9	33	288	315	11,75
15-2123-1	1	21x23	31.0	33.2	12.3	13.3	33	310	341	13,37
15-2426-1	1	24x26	34.8	39.2	13.7	14.3	34	330	478	16,54
15-2427-1	1	24x27	34.8	39.2	13.7	14.3	34	330	475	16,79
15-2528-1	1	25x28	36.6	40.5	14.2	14.7	35	348	548	19,29
15-2729-1	1	27x29	42.0	45.2	15.0	16.0	37	372	662	21,40
15-3032-1	1	30x32	42.2	45.5	14.8	15.8	37	372	635	23,52
15-3236-2	1	32x36	48.5	54.0	16.5	17.8	41	417	962	37,44
15-3641-2	1	36x41	53.5	62.0	17.3	19.2	48	450	1.037	46,84

JUEGO 8 LLAVES DE ESTRELLA ACODADAS



- Acero aleado de alto rendimiento cromado acabado mate
- Dureza: 42-48 HRc
- ISO 10104 y DIN 838

E				g	€
15-8-H	1	8	6-7, 8-9, 10-11, 12-13, 14-15, 16-17, 18-19, 20-22 mm	1.245	63,09

JUEGO DE LLAVES DE ESTRELLA ACODADAS



- Acero aleado de alto rendimiento cromado acabado mate
- Dureza: 42-48 HRc
- ISO 10104 y DIN 838

E				g	€
15-8-W	1	8	6-7, 8-9, 10-11, 12-13, 14-15, 16-17, 18-19, 20-22 mm	1.350	66,40
15-12-W	1	12	6-7, 8-9, 10-11, 12-13, 14-15, 16-17, 18-19, 20-22, 21-23, 24-27, 25-28, 30-32 mm	3.465	136,36

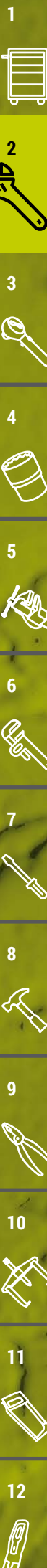



LLAVES DE PIPA

LLAVE DE PIPA ABIERTA

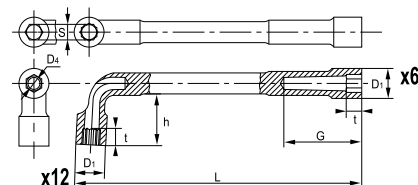

- Acero aleado de alto rendimiento cromado acabado mate
- Dureza: 40-50 HRc
- ISO 1711 / ISO 691 / ISO 2236
- -1 Envase individual

6x12		6x6		S	X	D1 mm	D4 mm	G mm	h mm	t mm	L mm	g	6x12		6x6	
E	R	€	€													
51-06-1	52-06-1	6	1	10	4.5	21.0	17	6.0	102	30	8,46	8,46				
51-07-1	52-07-1	7	1	11	4.5	22.0	17.5	7.0	106	40	8,84	8,84				
51-08-1	52-08-1	8	1	12.5	7.0	25.0	19.5	8.0	114	60	9,01	9,01				
51-09-1	52-09-1	9	1	13.5	7.0	26.0	20.0	9.0	122	70	9,80	9,80				
51-10-1	52-10-1	10	1	15.0	8.0	28.0	24.0	10.0	129	90	10,15	10,15				
51-11-1	52-11-1	11	1	16.5	8.0	30.0	26.5	11.0	136	120	10,62	10,62				
51-12-1	52-12-1	12	1	18.0	9.0	36.0	28.0	11.0	144	150	11,14	11,14				
51-13-1	52-13-1	13	1	19.5	9.0	38.6	30.0	12.0	152	160	12,16	12,16				
51-14-1	52-14-1	14	1	21.0	10.5	40.0	31.5	13.0	160	190	13,19	13,19				
51-15-1	52-15-1	15	1	22.5	10.5	42.0	34.0	14.0	169	200	14,21	14,21				
51-16-1	52-16-1	16	1	24.0	13.0	46.0	37.0	16.0	178	280	15,65	15,65				
51-17-1	52-17-1	17	1	25.5	13.0	48.0	39.0	17.0	187	300	15,97	15,97				
51-18-1	52-18-1	18	1	26.5	13.0	50.0	40.0	18.0	195	310	17,42	17,42				
51-19-1	52-19-1	19	1	28.5	15.0	51.0	41.0	19.0	204	420	18,05	18,05				
51-20-1	52-20-1	20	1	29.5	15.0	53.0	43.0	20.0	212	450	20,20	20,20				
51-21-1	52-21-1	21	1	30.5	15.0	55.0	46.0	21.0	221	470	22,38	22,38				
51-22-1	52-22-1	22	1	32.0	15.0	57.0	48.0	22.0	230	530	24,12	24,12				
51-23-1	52-23-1	23	1	33.5	18.0	64.0	50.5	23.0	240	650	27,54	27,54				
51-24-1	52-24-1	24	1	34.5	18.0	67.0	54.0	24.0	250	630	27,95	27,95				
51-25-1	52-25-1	25	1	36.0	20.0	69.0	56.0	25.0	260	830	30,71	30,71				
51-26-1	52-26-1	26	1	37.0	20.0	70.0	58.5	26.0	270	860	34,54	34,54				
51-27-1	52-27-1	27	1	38.0	22.0	73.0	58.0	27.0	280	990	37,62	37,62				
51-28-1	52-28-1	28	1	39.5	22.0	75.0	60.0	28.0	290	1.000	41,22	41,22				
51-29-1	52-29-1	29	1	41.0	22.0	76.0	62.0	29.0	300	1.080	44,01	44,01				
51-30-1	52-30-1	30	1	42.0	24.0	83.0	64.0	30.0	310	1.220	46,48	46,48				
51-32-1	52-32-1	32	1	44.5	24.0	88.0	70.0	31.0	330	1.380	48,24	48,24				

JUEGO DE LLAVES DE PIPA ABIERTAS



- Llave de pipa de dos bocas
- Acero aleado de alto rendimiento cromado acabado mate
- Dureza: 40-50 HRc
- ISO 1711 / ISO 691 / ISO 2236

E	R	S	X	g	€
51-8-W	52-8-W	1	8	8, 10, 11, 13, 14, 17, 19, 22 mm	1.980 117,50
51-8-W	52-8-W	1	8	8, 10, 11, 13, 14, 17, 19, 22 mm	1.980 117,50



LLAVES DE TUBO

LLAVES DE TUBO DOS BOCAS FORJADA

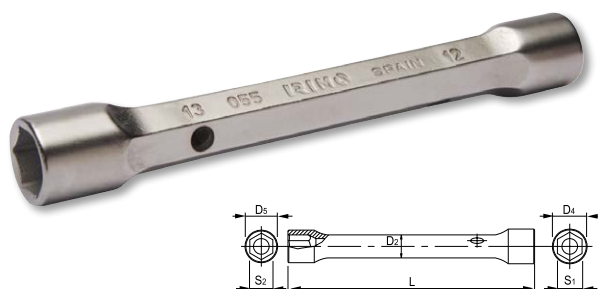

- Acero aleado de alto rendimiento cromado acabado mate
- A partir de la medida de 16, con agujero pasante longitudinal
- Dureza: 42-48 HRc
- UNE 16586

R	📦	S1x S2 mm	D4 mm	D5 mm	D2 mm	L mm	g	€
055011	10	6x7	10	11	7	103	31	11,47
055031	10	8x9	12.5	13.5	9	108	53	11,60
055051	10	10x11	15	16	11	120	78	12,39
055071	10	12x13	17	19	13	138	127	14,55
055091	10	14x15	20	21	14	143	152	16,38
055121	10	16x17	22	24	16	153	185	19,28
055141	10	18x19	25	26	18	163	235	22,68
055171	10	20x22	28	30	20	173	312	25,84
055181	5	21x23	29	31	21	183	359	28,71
055201	5	24x26	33	35	24	193	438	30,68
055211	5	24x27	33	37	24	193	466	31,20
055221	5	25x28	34	37	25	203	535	35,41
055241	5	27x29	37	39	27	208	592	40,37
055251	5	30x32	40	43	30	208	737	44,99

JUEGO LLAVES DE TUBO DOS BOCAS FORJADAS



- Acero aleado de alto rendimiento cromado acabado mate
- A partir de la medida de 16, con agujero pasante longitudinal
- Dureza: 42-48 HRc
- UNE 16586

R	📦	📦	🔧	g	€
056231	1	8	6-7, 8-9, 10-11, 12-13, 14-15, 16-17, 18-19, 20-22 mm	1.150	138,99
056271	1	12	6-7, 8-9, 10-11, 12-13, 14-15, 16-17, 18-19, 20-22, 21-23, 24-26, 25-28, 30-32 mm	3.200	280,58

MANGO ESCALONADO PARA LLAVE DE TUBO

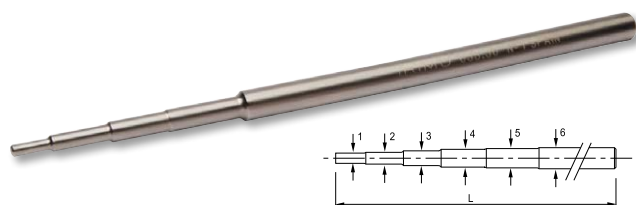

- Acero aleado de alto rendimiento
- Dureza: 42-48 HRc
- DIN 900

R	📦	1	2	3	4	5	6	L mm	g	€		
055301	1	3.1	4.3	5.3	5.8	8	-	6x7	14x15	175	54	9,91
055311	1	6.8	7.8	9.8	11.8	12.8	14	16x17	30x32	270	251	13,84



LLAVES DE GOLPE Y TRACCIÓN

LLAVE DE ESTRELLA DE GOLPE

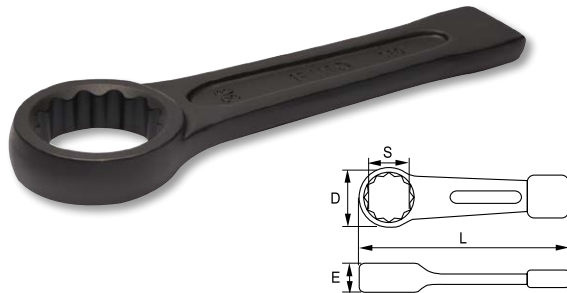

- Acero aleado de alto rendimiento
- Dureza: 24-46 mm, 34-40 HRc
50-100 mm, 30-36 HRc
- DIN 7444

R	📦	S mm	D mm	E mm	L mm	g	€
30-24-2	1	24	43	15	165	235	32,69
30-27-2	1	27	46	16	180	290	35,56
30-30-2	1	30	53	18	195	435	36,63
30-32-2	1	32	53	18	195	415	36,63
30-34-2	1	34	59	18	205	510	41,51
30-36-2	1	36	59	18	205	510	46,76
30-38-2	1	38	59	18	205	510	55,03
30-41-2	1	41	65	20	230	710	51,86
30-46-2	1	46	74	22.5	240	980	65,44
30-50-2	1	50	79	24	255	1.050	73,57
30-55-2	1	55	86	25	270	1.410	84,14
30-60-2	1	60	93	26	280	1.640	88,71
30-65-2	1	65	103	29	300	2.180	92,21
30-70-2	1	70	109	33	315	2.400	96,22
30-75-2	1	75	114	34	330	2.775	103,34
30-80-2	1	80	125	36	348	3.150	137,47
30-85-2	1	85	129	37	360	4.860	184,09
30-90-2	1	90	148	40	379	5.680	240,68
30-95-2	1	95	151	41	395	6.500	265,93
30-100-2	1	100	154	45	405	7.830	299,47

LLAVE FIJA DE GOLPE

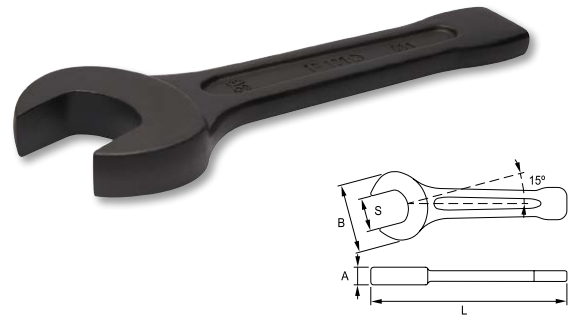

- Acero aleado de alto rendimiento
- Dureza: 30-46 mm, 34-40 HRc
50-85 mm, 30-36 HRc
- DIN 133

R	📦	S mm	A mm	B mm	L mm	g	€
31-30-2	1	30	17	65	190	550	21,40
31-32-2	1	32	17	67	195	560	22,71
31-36-2	1	36	18	77	210	845	29,25
31-41-2	1	41	19	88	230	1.040	35,87
31-46-2	1	46	20	96	250	1.375	48,31
31-50-2	1	50	21	106	275	1.670	55,03
31-55-2	1	55	24	116	305	2.175	64,19
31-60-2	1	60	24	125	315	2.455	76,43
31-65-2	1	65	28	136	345	3.550	95,77
31-70-2	1	70	30	148	370	4.075	115,16
31-75-2	1	75	30	158	385	5.170	123,31
31-80-2	1	80	33	170	400	5.785	172,53
31-85-2	1	85	33	174	410	6.870	205,43

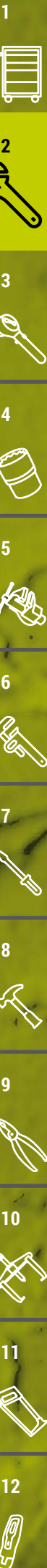

LLAVES DE GANCHO

PIVOTE FIJO

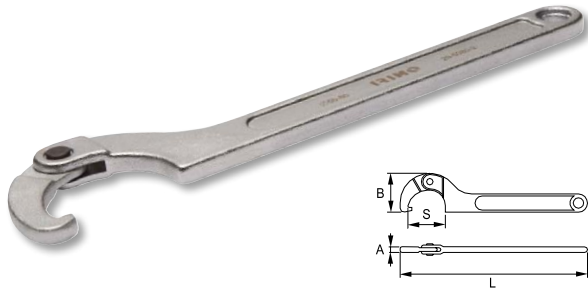

- Acero aleado de alto rendimiento cromado acabado mate
- Dureza: 40 HRc
- DIN 137-B

R	📦	S mm	A mm	B mm	L mm	g	€
29-3550-2	1	35-50	6	38	202	186	24,08
29-5080-2	1	50-80	8	55	280	382	32,83
29-80120-2	1	80-120	9	75	345	642	45,93

PIVOTE REEMPLAZABLE



- Acero aleado de alto rendimiento cromado acabado mate
- Dureza: 40 HRc
- DIN 137-B

R	📦	S mm	A mm	B mm	L mm	g	€
29P-3550-2	1	35-50	11	38	202	186	26,27
29P-5080-2	1	50-80	14	55	280	382	35,69
29P-80120-2	1	80-120	18	75	345	642	49,85

REPUESTO PIVOTE REEMPLAZABLE



- Acero aleado de alto rendimiento cromado

R	📦	🔧	D mm	g	€
29P-3550-A	1	29P-3550-2	4	5	5,21
29P-5080-A	1	29P-5080-2	5	9	5,91
29P-80120-A	1	29P-80120-2	6	19	6,49

LLAVE UNIVERSAL

LLAVE UNIVERSAL 7 EN 1



- Llave universal adecuada para todas las cerraduras más comunes
- 1 llave para 7 aplicaciones diferentes
- Llave para liberación del aire de los radiadores en la parte central
- Para sistemas de electricidad, calefacción, ventilación y aire acondicionado además de aplicaciones de construcción
- Hecho en fundición de zinc, con cadena, adaptador y punta (1,2x7 mm y PH2)
- Dimensiones: 72x72 mm
- Embalaje en blíster

R	📦	🕒	⊕	⊖	⚙️	📏	📦	€	
71-UN7-1	1	1.2	PH-2	3-5	9	3-5	72x72	89	16,89

LLAVE UNIVERSAL 9 EN 1



- Llave universal para las formas más comunes
- 1 llave para 9 aplicaciones diferentes
- Cuadrado: 5,6,7-8 mm, Triangular: 9-10 mm
- Llave de dos sentidos: 6-9 mm
- Para sistemas de electricidad, calefacción, ventilación y aire acondicionado además de aplicaciones de construcción
- Hecho en fundición de zinc, con cadena, adaptador y punta (1,2x7 mm y PH2)
- Dimensiones: 90x62 mm
- Embalaje en blíster

R	📦	🕒	⊕	⊖	⚙️	📏	📦	€	
71-UN9-1	1	1.2	PH-2	5-7-8	9-10	9-10	90x62	87	15,67





03. HERRAMIENTAS DINAMOMÉTRICAS



LLAVES DINAMOMÉTRICAS

DINAMOMÉTRICA DE DISPARO AJUSTABLE CON CARRACA FIJA

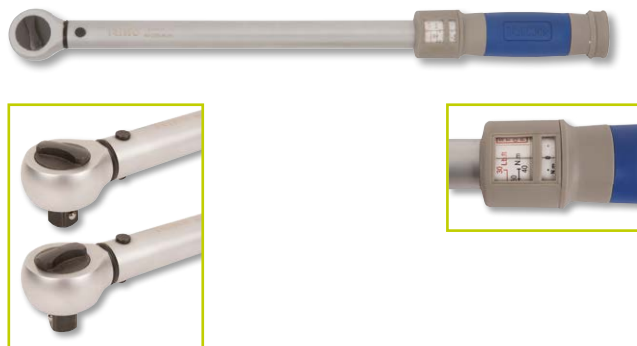

DINAMOMÉTRICA DE DISPARO AJUSTABLE CON CABEZA INTERCAMBIABLE



- Precisión: $\pm 4\%$
- Cabeza fija
- Carraca reversible de 45 dientes con ángulo de acción 8°
- Mango de plástico para mayor confort
- ISO 6789

R	📦	Ø	N-m	Δ N-m	L mm	kg	€
070411	1	1/4"	4-20	0.050	275	0.5	148,82
070421	1	3/8"	10-60	0.125	360	0.8	148,82
070431	1	1/2"	25-125	0.25	420	0.9	153,97
070441	1	1/2"	40-200	0.5	460	1.0	161,66
070451	1	1/2"	65-335	0.5	520	1.2	177,06
070461	1	3/4"	65-335	0.5	520	1.2	184,75
070471	1	3/4"	150-800	2	1.040	4.9	642,70
070481	1	1"	300-1500	3	1.250	8.2	1.280,81

- Precisión: $\pm 4\%$
- Cabezas intercambiables 9x12 y 14x18 mm
- Mango de plástico para mayor confort
- ISO 6789

R	📦	🔗	N-m	Δ N-m	L mm	kg	€
7309-30	1	9x12	6-30	0.050	298	0.6	130,95
7309-60	1	9x12	10-60	0.125	367	0.7	130,95
7309-125	1	9x12	25-125	0.25	422	0.8	149,33
7314-200	1	14x18	40-200	0.5	455	0.9	164,80
7314-335	1	14x18	65-335	0.5	515	1.1	178,37

CABEZA INTERCAMBIABLE DE BOCA ABIERTA 9x12 MM

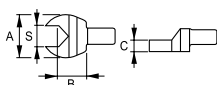
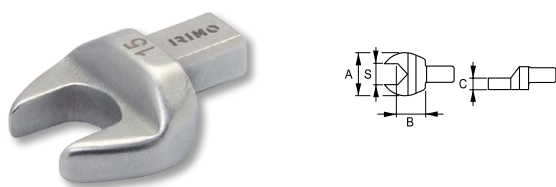

CABEZA INTERCAMBIABLE DE BOCA ESTRELLA 9x12 MM

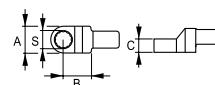
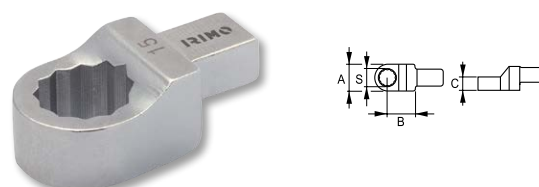

- Cabeza intercambiable de boca abierta 9x12 mm
- Acero forjado cromado

R	📦	S mm	A mm	B mm	C mm	g	€
7309-1-10	1	10	25	17.5	5.7	40	25,49
7309-1-11	1	11	26	17.5	5.7	40	25,49
7309-1-12	1	12	28	17.5	5.7	45	25,49
7309-1-13	1	13	29	17.5	5.7	45	25,49
7309-1-14	1	14	32	20.0	7.7	50	25,49
7309-1-17	1	17	38	20.0	7.7	60	25,49
7309-1-19	1	19	42	20.0	7.7	70	25,49

- Cabeza intercambiable de boca estrella 9x12 mm
- Acero forjado cromado

R	📦	S mm	A mm	B mm	C mm	g	€
7309-2-10	1	10	18	17.5	8	40	27,63
7309-2-11	1	11	19	17.5	8	40	27,63
7309-2-12	1	12	20	17.5	12	50	27,63
7309-2-13	1	13	21	17.5	12	50	27,63
7309-2-14	1	14	23	17.5	12	50	27,63
7309-2-17	1	17	27	17.5	13	50	27,63
7309-2-19	1	19	31	17.5	13	60	27,63
7309-2-22	1	22	35	17.5	15	80	27,63



CABEZA INTERCAMBIABLE DE CABEZA DE CARRACA 9x12 Y 14x18 MM

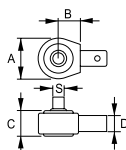

- Inserto cuadrado carraca de 1/4", 3/8" y 1/2" para 9x12 mm
- Inserto cuadrado carraca de 1/2" para 14x18 mm
- Número de dientes 45 con ángulo de acción 8°
- Acero forjado cromado

E		S mm	A mm	B mm	C mm	D mm	Max Nm	g	€
7309-1/4	1	1/4"	37	18	20	9x12	25	135	58,07
7309-3/8	1	3/8"	38	18	20	9x12	160	160	60,41
7309-1/2	1	1/2"	38	18	20	9x12	160	160	61,66
7314-1/2	1	1/2"	40	25	20	14x18	420	265	65,08

CABEZA INTERCAMBIABLE DE BOCA ABIERTA 14x18 MM

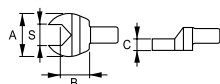

- Cabeza intercambiable de boca abierta 14x18 mm
- Acero forjado cromado

E		S mm	A mm	B mm	C mm	g	€
7314-1-13	1	13	30	25.0	7	130	29,06
7314-1-14	1	14	31	25.0	7	130	29,06
7314-1-17	1	17	37	25.0	9	135	29,06
7314-1-19	1	19	41	25.0	9	140	29,06
7314-1-22	1	22	47	25.0	11	170	34,92
7314-1-24	1	24	51	25.0	11	180	34,92
7314-1-27	1	27	59	32.5	14	220	39,55
7314-1-30	1	30	63	32.5	14	240	39,55
7314-1-32	1	32	65	32.5	14	240	39,55

CABEZA INTERCAMBIABLE DE BOCA ESTRELLA 14x18 MM

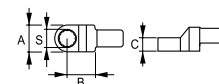

- Cabeza intercambiable de boca estrella 14x18 mm
- Acero forjado cromado

E		S mm	A mm	B mm	C mm	g	€
7314-2-13	1	13	21	25	12	120	30,24
7314-2-14	1	14	23	25	12	120	30,24
7314-2-17	1	17	28	25	13	130	30,24
7314-2-19	1	19	30	25	13	140	30,24
7314-2-22	1	22	35	25	15	145	34,92
7314-2-24	1	24	38	25	15	145	34,92
7314-2-27	1	27	42	31	18	170	34,92
7314-2-30	1	30	45	31	18	180	39,55
7314-2-32	1	32	48	31	18	180	39,55
7314-2-36	1	36	53	31	19	205	43,05
7314-2-41	1	41	59	31	19	235	43,05



FUERZAS DE PRETENSADO Y PARES DE APRIETE RECOMENDADOS

	paso mm			sección mm ²	coeficiente de rozamiento	CALIDAD DE TORNILLO											
						4,8		5,8		6,8		8,8		10,9		12,9	
						Pretensado N	Apriete Nm	Pretensado N	Apriete Nm	Pretensado N	Apriete Nm	Pretensado N	Apriete Nm	Pretensado N	Apriete Nm	Pretensado N	Apriete Nm
M2	040	40	15	207	0,10 0,14	4480 4495	0,15 0,19	610,6 561,9	0,19 0,23	732,7 674,3	0,23 0,28	976,9 899,0	0,31 0,37	1373,8 1264,3	0,43 0,52	1648,6 1517,1	0,52 0,63
M2,5	045	50	20	3,39	0,10 0,14	813,5 749,9	0,31 0,38	1016,9 937,4	0,39 0,48	1220,2 1124,9	0,47 0,58	1627,0 1499,8	0,63 0,77	2288,0 2109,1	0,88 1,08	2745,6 2531,0	1,06 1,30
M3	050	55	25	5,03	0,10 0,14	1219,9 1125,9	0,54 0,60	1524,9 1407,4	0,68 0,83	1829,9 1688,9	0,82 1,00	2439,9 2251,9	1,09 1,34	3431,0 3166,7	1,53 1,88	4117,2 3800,0	1,84 2,26
M3,5	060	60	-	6,78	0,10 0,14	1638,2 1511,3	0,84 1,03	2047,8 1889,2	1,05 1,28	2457,3 2267,0	1,26 1,54	3276,4 3022,6	1,68 2,05	4607,5 4250,6	2,36 2,89	5528,9 5100,7	2,84 3,47
M4	070	70	30	8,78	0,10 0,14	2115,4 1950,9	1,25 1,53	2644,3 2438,7	1,56 1,91	3173,1 2926,4	1,88 2,29	4230,8 3901,9	2,50 3,06	5949,6 5487,0	3,52 4,30	7139,5 6584,4	4,22 5,16
M5	080	80	40	14,20	0,10 0,14	34616 31968	2,46 3,02	4327,0 3996,0	3,08 3,78	5192,3 4795,2	3,70 4,53	6923,1 6393,7	4,93 6,04	9735,7 8991,1	6,93 8,50	11682,8 10789,3	8,32 10,20
M6	100	100	50	20,10	0,10 0,14	48747 44991	4,24 5,19	6093,4 5623,9	5,30 6,48	7312,1 6748,6	6,35 7,78	9749,4 8998,2	8,47 10,37	13710,1 12653,7	11,92 14,59	16452,2 15184,4	14,30 17,51
M7	100	110	-	28,90	0,10 0,14	71345 65996	6,97 8,60	8918,2 8249,5	8,71 10,76	10701,8 9899,4	10,45 12,90	14269,1 13199,2	13,94 17,21	20065,9 18561,4	19,60 24,20	24079,1 22273,6	23,52 29,04
M8	125	130	60	36,60	0,10 0,14	89471 82656	10,20 12,54	11183,9 10332,0	12,75 15,67	13420,7 12398,4	15,30 18,80	17894,2 16531,2	20,41 25,07	25163,7 23247,0	28,70 35,26	30196,5 27896,5	34,44 42,31
M10	150	160	80	58,00	0,10 0,14	142445 131674	20,11 24,76	17805,6 16459,2	25,14 30,95	21366,8 19751,1	30,16 37,14	28489,0 26334,8	40,22 49,52	40062,7 37033,3	56,56 69,64	48075,3 44439,9	67,87 83,56
M12	175	180	100	84,30	0,10 0,14	207666 192040	34,43 42,42	25958,3 24005,0	43,03 53,03	31149,9 28806,0	51,64 63,63	41533,2 38408,0	68,86 84,84	58406,1 54011,2	96,83 119,31	70087,3 64813,5	116,20 143,17
M14	200	210	120	115,00	0,10 0,14	283899 262612	54,77 67,56	35487,4 32826,5	68,46 84,45	42584,9 39391,8	82,15 101,34	56779,8 52522,4	109,53 135,13	79846,6 73859,6	154,03 190,02	95816,0 88631,5	184,84 228,03
M16	200	240	140	157,00	0,10 0,14	392421 363642	85,14 105,80	49052,7 45455,3	106,43 132,26	58863,2 54546,3	127,72 158,71	78484,3 72728,5	170,29 211,61	110368,5 102274,4	239,47 297,58	132442,2 122729,3	287,36 357,09
M18	250	270	140	192,00	0,10 0,14	47533,0 43986,1	117,48 145,16	59416,3 54982,7	146,85 181,45	71299,6 65979,2	176,22 217,74	95066,1 87972,3	234,96 290,32	133686,7 123711,0	330,41 402,26	160424,1 148453,2	396,49 489,92
M20	250	300	170	245,00	0,10 0,14	61238,0 56747,1	166,08 206,39	76547,5 70933,9	207,61 257,98	91857,0 85120,6	249,13 309,58	122476,0 113494,2	332,17 412,78	172231,9 159601,2	467,11 580,47	206678,2 191521,5	560,54 696,56
M22	250	340	170	303,00	0,10 0,14	76305,2 70791,9	227,22 283,79	95381,5 88489,8	284,02 354,74	114457,8 106187,8	340,82 425,69	152610,4 141583,7	454,43 567,58	214608,3 199102,1	639,05 798,16	257530,0 238922,5	766,85 957,80
M24	300	360	190	353,00	0,10 0,14	88232,4 81761,8	287,16 356,84	110290,5 102202,2	358,94 446,05	132348,6 122642,7	430,73 535,26	176646,9 163523,6	574,31 713,68	248153,7 229955,1	807,63 1003,61	297784,4 275921,3	969,15 1204,33
M27	300	410	190	459,00	0,10 0,14	115778,8 107441,5	420,04 525,08	144723,5 134301,9	525,05 656,35	173668,2 161162,2	306,06 387,62	231557,6 214883,0	840,08 1050,16	325627,9 302179,2	1181,36 1476,79	390753,4 362615,0	1417,63 1772,15
M30	350	460	220	561,00	0,10 0,14	140999,5 130770,6	572,83 714,49	176249,4 163463,3	716,03 893,11	211499,3 196155,9	859,24 1071,73	281999,0 261541,2	1145,65 1428,97	396561,1 367792,3	1611,08 2009,49	475873,4 441350,8	1933,29 2411,39
M33	350	500	220	694,00	0,10 0,14	175618,1 163058,0	774,65 970,43	219522,6 203822,5	968,32 1213,03	263427,1 24587,0	1161,98 1455,64	351236,2 326115,9	1549,31 1940,86	493925,8 458600,5	2178,72 2729,33	592711,0 550320,6	2614,46 3275,19
M36	400	550	240	817,00	0,10 0,14	206081,7 191241,8	998,60 1248,41	257602,2 239052,3	1248,25 1560,51	309122,6 286862,7	1497,89 1872,61	412163,5 382483,6	1997,19 2496,81	579604,8 537867,6	2808,55 3511,14	695525,8 645441,1	3370,26 4213,37
M39	400	600	270	976,00	0,10 0,14	247520,0 229902,6	1291,81 1620,96	309400,0 287378,3	1614,77 2026,20	371279,9 344853,9	1937,72 2431,44	495039,9 459805,2	2583,63 3241,92	696149,8 646601,0	3633,23 4558,96	835379,8 775921,3	4359,88 5470,75
M42	450	650	-	1120,00	0,10 0,14	283225,0 262939,0	1601,25 2005,46	354031,2 328673,8	2001,57 2506,83	424837,4 394408,5	2401,88 3008,20	566449,9 525878,0	3202,51 4010,93	796570,1 739516,0	4503,53 5640,37	955884,2 887419,2	5404,23 6768,44
M45	450	700	320	1310,00	0,10 0,14	332751,5 309151,8	2005,51 2519,55	415939,4 386439,7	2506,89 3149,43	499127,3 463727,7	3008,26 3779,32	665503,0 618303,6	4011,02 5039,09	935863,6 869489,3	5640,50 7086,23	1123036,0 1043387,0	6768,60 8503,47
M48	500	750	-	1470,00	0,10 0,14	372429,3 345862,9	2406,51 3018,11	465536,6 432328,7	3008,14 3772,64	558644,0 518794,4	3609,77 4527,17	744858,6 691725,8	4813,03 6036,23	1047457,0 972739,4	6768,32 8488,45	1256949,0 1167287,0	8121,98 10186,14
M52	500	800	360	1760,00	0,10 0,14	448108,9 416499,0	3099,96 3900,52	560136,1 520623,8	3874,95 4875,65	672163,4 624748,5	4649,93 5850,78	896217,8 832998,0	6199,91 7801,04	1260306,0 1171404,0	8718,63 10970,21	1512368,0 1405684,0	10462,36 13164,25
M56	550	850	410	2030,00	0,10 0,14	516202,9 479683,4	3838,14 4824,40	645253,6 599604,2	4797,68 6030,50	774304,4 719525,1	5757,21 7236,60	1032406,0 959366,8	7676,29 9648,80	1451821,0 1349110,0	10794,78 13568,63	1742185,0 1618931,0	12953,73 16282,36
M60	550	900	-	2360,00	0,10 0,14	602498,5 560267,5	4754,64 5992,71	753123,1 700334,4	5943,30 7490,88	903747,8 840401,2	7131,96 8989,06	1204997,0 1120535,0	9509,28 11985,42	1694527,0 1575752,0	13372,43 16854,49	2033432,0 1890903,0	16046,91 20225,39
M64	600	950	460	2680,00	0,10 0,14	683339,5 635299,9	5746,17 7235,13	854174,4 794124,9	7182,71 9043,92	1025009,0 952949,8	8619,25 10852,70	1366679,0 1270600,0	11492,34 14470,27	1921892,0 1786781,0	16161,10 20348,82	2306271,0 2144137,0	19393,32 24418,58
M68	600	1000	-	3060,00	0,10 0,14	782799,9 728201,8	6939,64 8758,24	978499,8 910252,2	8674,55 10947,80	1174200,0 1092303,0	10409,46 13137,36	1565600,0 1456404,0	13879,28 17516,48	2201625,0 2048068,0	19517,74 24632,55	2641950,0 2457681,0	23421,29 29559,06

A woman wearing safety glasses and black gloves is working on a ceiling fixture. She is using a screwdriver with a blue handle and a flashlight to illuminate the work area. The background is a blurred industrial or workshop setting.

04. VASOS Y ACCESORIOS



VASOS 1/4"

VASOS 1/4" HEX

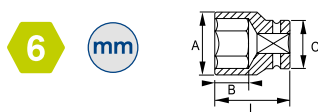

- Vasos en milímetros, diseño hexagonal
- Acero aleado Cromo Vanadio
- Acabado cromado brillante
- Perfil NPP
- DIN 3120, DIN 3124

R			A mm	B mm	C mm	L mm	g	€
101-04-1	5	4	6.9	9.0	12.0	25.0	11	3,55
101-045-1	5	4.5	7.5	9.0	12.0	25.0	11	3,55
101-05-1	5	5	8.2	9.0	12.0	25.0	11	3,55
101-055-1	5	5.5	8.8	9.0	12.0	25.0	12	3,55
101-06-1	5	6	9.4	9.0	12.0	25.0	11	3,55
101-07-1	5	7	11.0	9.0	12.0	25.0	13	3,55
101-08-1	5	8	12.0	12.0	12.0	25.0	13	3,55
101-09-1	5	9	13.0	12.0	13.0	25.0	15	3,55
101-10-1	5	10	14.0	12.0	12.6	25.0	21	3,55
101-11-1	5	11	16.0	12.0	14.0	25.0	24	3,55
101-12-1	5	12	17.0	12.0	14.8	25.0	26	3,55
101-13-1	5	13	18.0	12.0	15.8	25.0	28	3,55
101-14-1	5	14	20.0	12.0	17.4	25.0	39	3,55



R			A mm	B mm	C mm	L mm	g	€
101A-05-1	5	5/32"	6.9	8.5	12.0	25.0	10	3,62
101A-06-1	5	3/16"	7.5	8.5	12.0	25.0	10	3,62
101A-07-1	5	7/32"	8.8	9.5	12.0	25.0	11	3,62
101A-08-1	5	1/4"	9.4	9.5	12.0	25.0	11	3,62
101A-09-1	5	9/32"	11.0	10.5	12.0	25.0	13	3,62
101A-10-1	5	5/16"	12.0	10.5	12.0	25.0	12	3,62
101A-11-1	5	11/32"	13.0	10.5	12.0	25.0	14	3,62
101A-12-1	5	3/8"	14.0	10.5	12.6	25.0	18	3,62
101A-14-1	5	7/16"	16.0	11.5	14.0	25.0	23	3,62
101A-16-1	5	1/2"	18.0	11.5	15.8	25.0	29	3,62
101A-18-1	5	9/16"	20.0	11.5	17.4	25.0	37	3,62

VASOS 1/4" TORX®

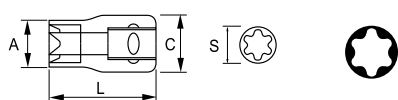

VASOS 1/4" HEX, SERIE LARGA

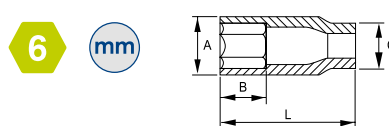

- Vasos en milímetros, diseño hexagonal
- Acero aleado Cromo Vanadio
- Acabado cromado brillante
- Perfil NPP
- DIN 3120

R			A mm	B mm	C mm	L mm	g	€
103-04-1	5	4	6.9	12.0	12.0	50.0	21	8,37
103-045-1	5	4.5	7.5	12.0	12.0	50.0	20	8,37
103-05-1	5	5	8.2	12.0	12.0	50.0	21	8,37
103-055-1	5	5.5	8.8	12.0	12.0	50.0	22	8,37
103-06-1	5	6	9.4	12.0	12.0	50.0	22	8,37
103-07-1	5	7	11.0	24.0	12.0	50.0	26	8,37
103-08-1	5	8	12.0	24.0	10.9	50.0	29	8,37
103-09-1	5	9	13.0	24.0	11.6	50.0	30	8,37
103-10-1	5	10	14.0	24.0	13.0	50.0	39	8,37
103-11-1	5	11	16.0	24.0	14.2	50.0	44	8,37
103-12-1	5	12	17.0	24.0	15.0	50.0	49	8,37
103-13-1	5	13	18.0	24.0	16.0	50.0	55	8,37
103-14-1	5	14	20.0	24.0	17.0	50.0	65	8,37



R			A mm	B mm	C mm	L mm	g	€
103A-06-1	5	3/16"	8.2	12.0	12.0	50.0	21	8,53
103A-08-1	5	1/4"	9.7	12.0	12.0	50.0	22	8,53
103A-09-1	5	9/32"	11.2	24.0	12.0	50.0	26	8,53
103A-10-1	5	5/16"	12.0	24.0	12.0	50.0	29	8,53
103A-11-1	5	11/32"	13.0	24.0	12.0	50.0	30	8,53
103A-12-1	5	3/8"	13.7	24.0	12.0	50.0	39	8,53
103A-14-1	5	7/16"	16.1	24.0	14.2	50.0	44	8,53
103A-16-1	5	1/2"	18.0	24.0	16.0	50.0	55	8,53

- Acero aleado Cromo Vanadio
- Acabado cromado brillante
- DIN 3120

R			S mm	A mm	B mm	L mm	g	€
106-04-1	5	E-4	3.8	6.0	12.0	25.0	10	3,79
106-05-1	5	E-5	4.7	7.0	12.0	25.0	11	3,79
106-06-1	5	E-6	5.7	8.0	12.0	25.0	11	3,79
106-07-1	5	E-7	6.2	8.6	12.0	25.0	11	3,79
106-08-1	5	E-8	7.5	10.3	12.0	25.0	12	3,79
106-10-1	5	E-10	9.4	12.3	13.0	25.0	21	3,79



VASOS CON PUNTA 1/4"

PUNTA PLANA



- Punta fabricada con acero especial S2
- DIN 3120

R			A mm	B mm	L mm	g	€
107-0840-1	5	0.8 x 4	11.8	20.0	37.5	15	3,23
107-1055-1	5	1 x 5.5	11.8	20.0	37.5	15	3,23
107-1280-1	5	1.2 x 8	11.8	20.0	37.5	16	3,23

PUNTA PHILLIPS



- Punta fabricada con acero especial S2
- DIN 3120

R			A mm	B mm	L mm	g	€
107-PH1-1	5	PH-1	11.8	20.0	37.5	15	3,36
107-PH2-1	5	PH-2	11.8	20.0	37.5	15	3,36
107-PH3-1	5	PH-3	11.8	20.0	37.5	16	3,36

PUNTA POZIDRIV



- Punta fabricada con acero especial S2
- DIN 3120

R			A mm	B mm	L mm	g	€
107-PZ1-1	5	PZ-1	11.8	20.0	37.5	15	3,36
107-PZ2-1	5	PZ-2	11.8	20.0	37.5	15	3,36
107-PZ3-1	5	PZ-3	11.8	20.0	37.5	16	3,36

PUNTA HEX



- Punta fabricada con acero especial S2
- DIN 3120

R			A mm	B mm	L mm	g	€
107-H3-1	5	3	11.8	20.0	37.5	15	3,09
107-H4-1	5	4	11.8	20.0	37.5	15	3,09
107-H5-1	5	5	11.8	20.0	37.5	16	3,09
107-H6-1	5	6	11.8	20.0	37.5	17	3,09
107-H8-1	5	8	11.8	20.0	37.5	19	3,09

R			A mm	B mm	L mm	g	€
107A-4-1	5	1/8"	11.8	20.0	37.5	15	3,13
107A-5-1	5	5/32"	11.8	20.0	37.5	15	3,13
107A-6-1	5	3/16"	11.8	20.0	37.5	16	3,13
107A-7-1	5	7/32"	11.8	20.0	37.5	17	3,13

PUNTA TORX®



- Punta fabricada con acero especial S2
- DIN 3120

R			S mm	A mm	C mm	L mm	g	€
107-T08-1	5	T8	2.3	11.8	20.0	37.5	15	4,01
107-T09-1	5	T9	2.5	11.8	20.0	37.5	15	4,01
107-T10-1	5	T10	2.7	11.8	20.0	37.5	15	4,01
107-T15-1	5	T15	3.3	11.8	20.0	37.5	15	4,01
107-T20-1	5	T20	3.8	11.8	20.0	37.5	15	4,01
107-T25-1	5	T25	4.4	11.8	20.0	37.5	15	4,13
107-T27-1	5	T27	5.0	11.8	20.0	37.5	16	4,13
107-T30-1	5	T30	5.5	11.8	20.0	37.5	16	4,13
107-T40-1	5	T40	6.6	11.8	20.0	37.5	16	4,13

1



2



3



4



5



6



7



8



9



10



11



12





ACCESORIOS 1/4"

CARRACA TIPO PERA

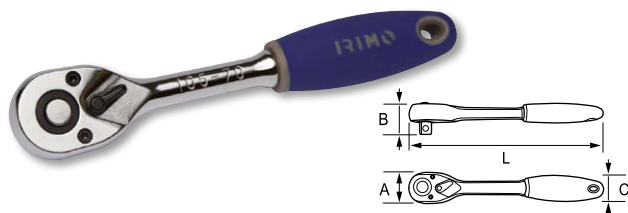

- 72 dientes / Ángulo de acción 5°
- Acabado cromado brillante
- Botón de rápida liberación
- Mango bicomponente
- DIN 3120, DIN 3122

R	📦	A mm	B mm	C mm	L mm	g	€
105-70-1	5	28	25	23	152	151	12,77

CARRACA REVERSIBLE REDONDA

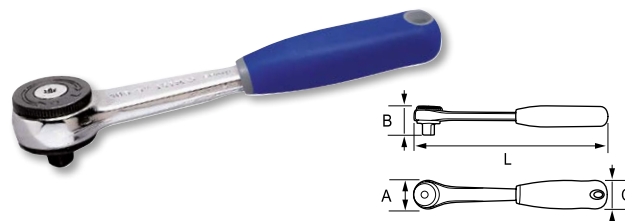

- 72 dientes / Ángulo de acción 5°
- Acabado cromado brillante
- DIN 3122/3120, ISO 3315, UNE 16512
- * Kit de reparación 105711

R	📦	A mm	B mm	C mm	L mm	g	€
105501	1	25	23	21	122	150	31,66

EXPOSITOR CON 12 CARRACAS DE 1/4"



- Carraca reversible
- 72 dientes / 5° de acción
- Acero de aleación de cromo vanadio
- Acabado cromado brillante
- Botón de rápida liberación
- Mango bicomponente
- Empuñadura acolchada de goma
- DIN 3122, DIN 3120
- Utilice el código 105-70-1 para hacer pedidos de carracas individuales

R	📦	X	📏	g	€
105-70-12DISP	1	12	160 x 150 x 230	2.590	153,24

JUEGO DE VASOS 1/4" EN RAIL, 11 piezas



- Juego de vasos de 1/4"
- Juego de vasos 11 piezas
- Vasos hexagonales, medidas métricas
- Acabado brillante cromado
- DIN 3120, DIN 3124, DIN 3122
- Presentación para colgar

R	📦	X	📏	g	€
109-11-4	5	11	232 x 60 x 15	250	41,28

101-04-1, 101-05-1, 101-06-1, 101-07-1, 101-08-1, 101-09-1, 101-10-1, 101-11-1, 101-12-1, 101-13-1, 101-14-1

JUEGO DE 1/4" CARRACA + 11 VASOS



- Juego de vasos 1/4", 13 piezas
- Vasos hexagonales, mm
- Acabado cromado brillante
- DIN 3120, DIN 3124, DIN 3122
- * Suministrado en display si se piden 12 unidades

R	📦	X	📏	g	€
109-13-4	8	13	254 x 70 x 30	460	31,27

105-70-1 105-24-1
 101-04-1, 101-05-1, 101-06-1, 101-07-1, 101-08-1, 101-09-1, 101-10-1, 101-11-1, 101-12-1, 101-13-1, 101-14-1



ALARGADERAS



• DIN 3120, DIN 3122

R	📦	A mm	B mm	L mm	g	€
105-22-1	5	8.1	12.2	50	20	4,02
105-24-1	5	8.1	12.2	100	38	5,46
105-26-1	5	8.1	12.2	150	65	5,77

MANGO CORREDIZO EN T

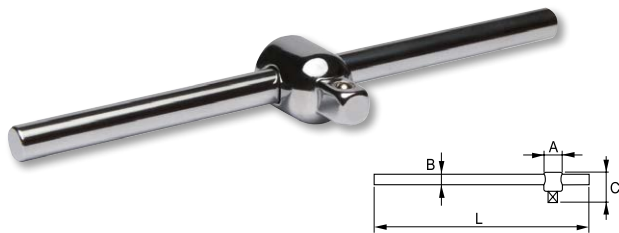

• DIN 3120, DIN 3122

R	📦	A mm	B mm	C mm	L mm	g	€
105-42-1	5	13.5	6.0	24	115	45	7,05

MANGO CUADRADO MACHO

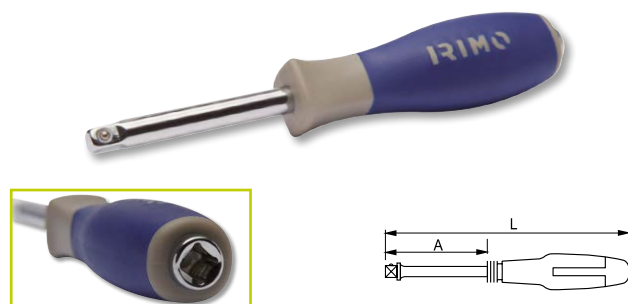

• Cuadrado hembra 1/4" en la cabeza
• DIN 3120

R	📦	A mm	L mm	□	□	g	€
105-50-1	5	61	150	1/4"	1/4"	88	8,01

AUMENTADOR

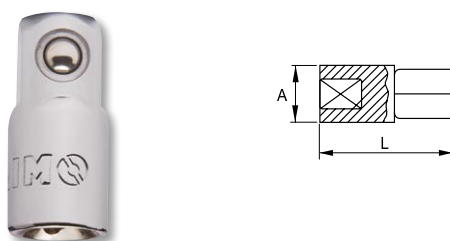

• Aumentador de 1/4" a 3/8"
• DIN 3120, DIN 3122

R	📦	A mm	L mm	g	€
105-46-1	5	12.0	26.0	31	5,46

ALARGADERA FLEXIBLE

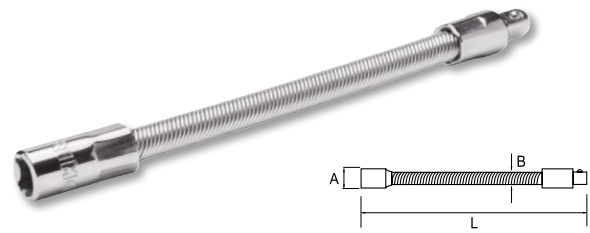

• DIN 3120

R	📦	A mm	B mm	L mm	g	€
105-28-1	5	12.5	8	148	57	9,13

ARTICULACIÓN UNIVERSAL

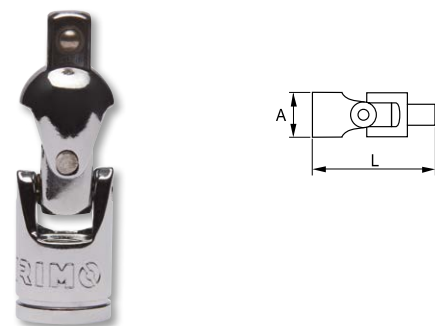

• DIN 3120, DIN 3122

R	📦	A mm	L mm	g	€
105-40-1	5	13.8	38.0	27	10,31

VASO PORTA PUNTAS 1/4"



• Hembra cuadrado 1/4" a hembra hex 1/4"
• DIN 3120

R	📦	A mm	L mm	g	€
105-48-1	5	11.9	25.0	12	4,24

1



2



3



4



5



6



7



8



9



10



11



12





JUEGO VASOS 1/4"

JUEGO DE VASOS Y PUNTAS DE 1/4", 23 piezas



- 23 vasos de 1/4" y conjunto de puntas DIN 3120 y DIN 3124
- Par de carraca según DIN 3122
- Carraca especial hexagonal de 1/4"; Reversible; 60 dientes; Longitud 90 mm
- Mango de carraca bi-material
- Caja de plástico ABS
- Incluye clip para el cinturón
- La carraca se vende como repuesto: SP121

€	Icono	Cantidad	Dimensiones	Peso	€	
109-23-4		1	23	110x75x45	340	31,19
101-06-1, 101-07-1, 101-08-1, 101-10-1, 101-11-1, 101-13-1						
475A-25-1						
475-PH1-1, 475-PH2-1						
475-PZ1-1, 475-PZ2-1						
475-4-1, 475-6.0-1						
475-H3-1, 475-H4-1, 475-H5-1, 475-H6-1						
475-T10-1, 475-T15-1, 475-T20-1, 475-T25-1, 475-T30-1						
SP121						

JUEGO VASOS 1/4", 35 piezas



- Juego vasos 35 piezas
- Vasos Hex mm
- Acabado cromado brillante
- DIN 3120, DIN 3124 y DIN 3122
- Caja fabricada en polietileno de alta densidad y resistente

JUEGO DE VASOS Y PUNTAS DE 1/4", 37 piezas



- Práctico juego de vaso y puntas hexagonales de 1/4", 37 piezas
- Portapuntas con sistema giratorio para un fácil acceso
- Práctica carraca reversible de 72 dientes. Longitud 105 mm
- Mangos bimateriales
- Acabado cromado brillante
- DIN 3120 y DIN 3124

€	Icono	Cantidad	Dimensiones	Peso	€	
109-37-4		1	37	45x100x150	780	36,05
x10 5.5-6-7-8-9-10-11-12-13-14 mm						
x1 1/4" x2 1/4" 50-100 mm						
x1 1/4" x1 1/4"						
x22 1/4"						
(3x) SL4-5-6 (3x) PZ1-2-3						
(5x) H3-4-5-6-7 (3x) PH1-2-3						
(7x) T10-15-20-25-27-30-40 (1x) 1/4"						

€	Icono	Cantidad	Dimensiones	Peso	€	
109-35-4		1	35	250 x 170 x 60	1.200	37,95
105-48-1 105-70-1						
105-42-1 105-50-1						
105-22-1 105-40-1						
105-24-1						
101-04-1, 101-045-1, 101-05-1, 101-055-1, 101-06-1, 101-07-1, 101-08-1, 101-09-1, 101-10-1, 101-11-1, 101-12-1, 101-13-1						
040001, 040011, 040021						
475-PH1-1, 475-PH2-1, 475-PH3-1						
475-PZ1-1, 475-PZ2-1, 475-PZ3-1						
475-4-1, 475-6.0-1						
475-H3-1, 475-H4-1, 475-H5-1, 475-H6-1						



JUEGO VASOS 1/4", 19 piezas



- Vasos Hex mm
- Acero aleado Cromo Vanadio
- Acabado cromado brillante
- DIN 3120, DIN 3124 y DIN 3122
- Caja fabricada en polietileno de alta densidad y resistente

R	📦	📦	📦	g	€
109-19-4	10	19	260x185x55	1.100	37,11
105-40-1			105-70-1		
105-42-1			105-50-1		
105-22-1			105-26-1		
101-04-1, 101-045-1, 101-05-1, 101-055-1, 101-06-1, 101-07-1, 101-08-1, 101-09-1, 101-10-1, 101-11-1, 101-12-1, 101-13-1, 101-14-1					

VASOS 3/8"

VASOS 3/8" HEX

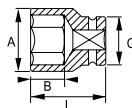

- Vasos en milímetros, diseño hexagonal
- Acero aleado Cromo Vanadio
- Acabado cromado brillante
- Perfil NPP
- DIN 3120, DIN 3124

R	📦	📏	A mm	B mm	C mm	L mm	g	€
112-06-1	5	6	10.5	9.0	17.0	28.0	21	2,17
112-07-1	5	7	11.0	9.0	17.0	28.0	24	2,17
112-08-1	5	8	12.2	9.0	17.0	28.0	27	2,17
112-09-1	5	9	13.5	9.0	17.0	28.0	26	2,17
112-10-1	5	10	14.7	9.0	17.0	28.0	24	2,17
112-11-1	5	11	16.0	9.0	17.0	28.0	26	2,17
112-12-1	5	12	18.0	15.0	17.0	28.0	24	2,17
112-13-1	5	13	19.0	15.0	17.0	28.0	29	2,39
112-14-1	5	14	20.0	15.0	17.7	28.0	38	2,39
112-15-1	5	15	22.0	15.0	17.9	28.0	40	2,39
112-16-1	5	16	22.0	15.0	17.9	28.0	46	2,81
112-17-1	5	17	24.0	15.0	18.8	30.0	56	2,81
112-18-1	5	18	26.0	15.0	19.8	30.0	75	3,09
112-19-1	5	19	26.0	15.0	20.7	30.0	66	3,09
112-20-1	5	20	28.0	15.0	21.8	30.0	88	3,09
112-21-1	5	21	28.0	15.0	21.8	30.0	84	3,36
112-22-1	5	22	30.0	15.0	22.8	32.0	104	3,36

VASOS 3/8" HEX, SERIE LARGA

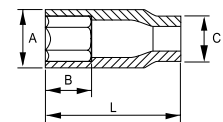

- Vasos en milímetros, diseño hexagonal
- Acero aleado Cromo Vanadio
- Acabado cromado brillante
- Perfil NPP
- DIN 3120

R	📦	📏	A mm	B mm	C mm	L mm	g	€
113-07-1	5	7	11.0	16.0	17.0	64.0	45	6,74
113-08-1	5	8	12.2	16.0	17.0	64.0	49	6,74
113-09-1	5	9	13.5	16.0	17.0	64.0	53	6,74
113-10-1	5	10	14.7	16.0	17.0	64.0	60	6,74
113-11-1	5	11	17.0	29.0	16.0	64.0	61	6,74
113-12-1	5	12	18.0	29.0	17.2	64.0	63	7,15
113-13-1	5	13	19.0	29.0	16.8	64.0	75	7,15
113-14-1	5	14	20.0	29.0	17.8	64.0	81	7,15
113-16-1	5	16	22.0	29.0	18.0	64.0	98	7,15
113-17-1	5	17	24.0	29.0	18.9	64.0	123	8,42
113-19-1	5	19	26.0	29.0	20.8	64.0	145	8,42

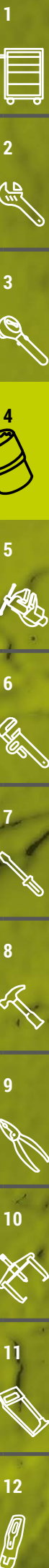



ACCESORIOS 3/8"

CARRACA TIPO PERA

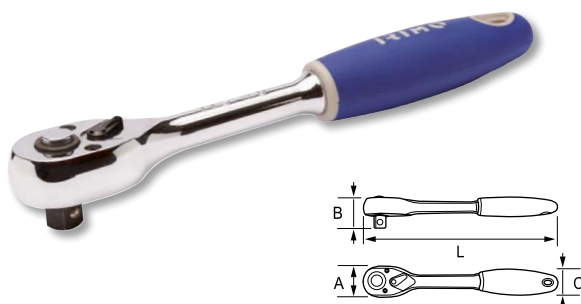

- 72 dientes / Ángulo de acción 5°
- Acabado cromado brillante
- Botón de rápida liberación
- Mango bicomponente
- DIN 3120, DIN 3122

R	📦	A mm	B mm	C mm	L mm	g	€
115-70-1	5	33	33	32	202	341	15,33

CARRACA REVERSIBLE REDONDA

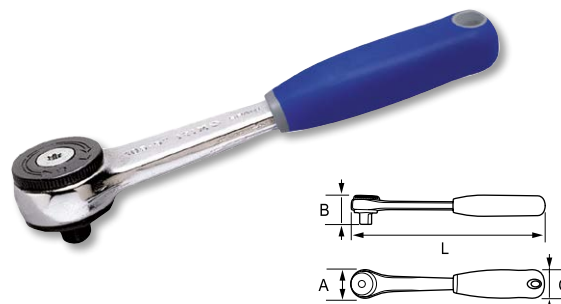

- 72 dientes / Ángulo de acción 5°
- Acabado cromado brillante
- DIN 3122, DIN 3120, ISO 3315, UNE 16512
- * Kit de reparación 115701

R	📦	A mm	B mm	C mm	L mm	g	€
115501	1	29	30	24	197	230	46,26

ALARGADERAS



- DIN 3120, DIN 3122

R	📦	A mm	B mm	L mm	g	€
115-20-1	5	17.0	12.1	75	125	4,23
115-22-1	5	17.0	12.1	150	138	5,77
115-24-1	5	17.0	12.1	250	232	6,10

MANGO CORREDIZO EN T



- DIN 3120, DIN 3122

R	📦	A mm	B mm	C mm	L mm	g	€
115-42-1	5	17.5	8.5	35	152	114	7,45

CABEZA MANGO CORREDIZO

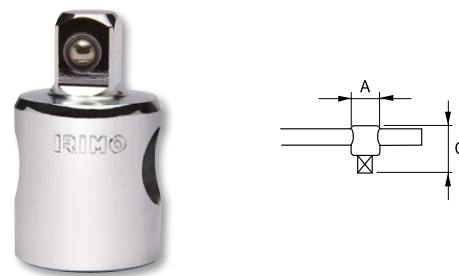

- DIN 3120

R	📦	A mm	C mm	g	€
115-43-1	5	24.0	40.5	30	5,46



ARTICULACIÓN UNIVERSAL



- DIN 3120, DIN 3122

Q	📦	A mm	L mm	g	€
115-40-1	5	17.8	59.0	61	10,90

REDUCTOR



- Adaptador reductor 3/8" a 1/4"
- DIN 3120

Q	📦	A mm	L mm	g	€
115-46-1	5	16.0	25.0	17	5,77

AUMENTADOR



- Aumentador de 3/8" a 1/2"
- DIN 3120

Q	📦	A mm	L mm	g	€
115-44-1	5	18.0	35.5	45	7,45

VASO PORTA PUNTAS



- Hembra cuadrado 3/8" a hembra hex 5/16"
- DIN 3120

Q	📦	🔩	A mm	L mm	g	€
115-48-1	5	5/16"	15.4	28.0	24	4,48

JUEGO VASOS 3/8"

JUEGO VASOS 3/8", 18 piezas



- Juego vasos 18 piezas
- Vasos Hex mm
- Acabado cromado brillante
- DIN 3120, DIN 3124 y DIN 3122
- Caja fabricada en polietileno de alta densidad y resistente

Q	📦	📦	📦	g	€
119-18-4	1	18	320 x 250 x 75	3.250	47,15

112-07-1, 112-08-1, 112-10-1, 112-11-1, 112-12-1, 112-13-1, 112-14-1, 112-15-1, 112-16-1, 112-17-1, 112-19-1, 112-21-1, 112-22-1	3/8"	
--	------	--

115-70-1	
----------	--

115-20-1, 115-22-1	
--------------------	--

115-40-1	
----------	--

115-43-1	
----------	--





VASOS 1/2"

VASOS 1/2" HEX

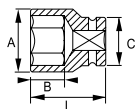

- Vasos en milímetros, diseño hexagonal
- Acero aleado Cromo Vanadio
- Acabado cromado brillante
- Perfil NPP
- DIN 3120, DIN 3124

VASOS 1/2" BIHEX

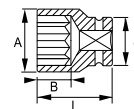

- Vasos en milímetros, diseño bi-hexagonal
- Acero aleado Cromo Vanadio
- Acabado cromado brillante
- Perfil NPP
- DIN 3120, DIN 3124

R			A mm	B mm	C mm	L mm	g	€
121-08-1	5	8	14.8	13.0	22.0	38.0	50	3,60
121-09-1	5	9	15.3	13.0	22.0	38.0	48	3,60
121-10-1	5	10	15.3	13.0	22.0	38.0	49	3,56
121-11-1	5	11	16.5	13.0	22.0	38.0	50	3,63
121-12-1	5	12	17.8	13.0	22.0	38.0	52	3,89
121-13-1	5	13	19.0	13.0	22.0	38.0	54	4,05
121-14-1	5	14	20.3	13.0	22.0	38.0	56	4,29
121-15-1	5	15	22.0	17.8	20.5	38.0	57	4,36
121-16-1	5	16	22.0	17.8	20.5	38.0	71	4,54
121-17-1	5	17	24.0	17.8	21.9	38.0	72	4,66
121-18-1	5	18	25.0	17.8	22.9	38.0	90	4,66
121-19-1	5	19	26.0	17.8	22.9	38.0	84	4,90
121-20-1	5	20	28.0	17.8	23.9	38.0	87	4,98
121-21-1	5	21	28.0	17.8	23.9	38.0	95	5,16
121-22-1	5	22	30.0	17.8	26.1	38.0	97	5,34
121-23-1	5	23	32.0	17.8	28.1	38.0	103	5,57
121-24-1	5	24	32.0	17.8	28.1	38.0	109	5,93
121-25-1	5	25	34.0	17.8	29.1	40.0	146	6,02
121-26-1	5	26	34.0	17.8	29.1	42.0	192	6,16
121-27-1	5	27	36.0	17.8	30.1	42.0	211	6,42
121-28-1	5	28	38.0	17.8	32.1	42.0	212	6,81
121-30-1	5	30	40.0	17.8	34.1	44.0	214	7,12
121-32-1	5	32	42.0	17.8	36.1	44.0	217	7,31
121-34-1	5	34	50.0	18.0	38.0	44.0	260	9,44
121-36-1	5	36	52.0	18.2	40.0	45.0	300	13,28

R			A mm	B mm	C mm	L mm	g	€
122-08-1	5	8	14.8	13.0	22.0	38.0	50	3,60
122-09-1	5	9	15.3	13.0	22.0	38.0	48	3,60
122-10-1	5	10	15.3	13.0	22.0	38.0	49	3,56
122-11-1	5	11	16.5	13.0	22.0	38.0	50	3,63
122-12-1	5	12	17.8	13.0	22.0	38.0	52	3,89
122-13-1	5	13	19.0	13.0	22.0	38.0	54	4,05
122-14-1	5	14	20.3	13.0	22.0	38.0	56	4,29
122-15-1	5	15	22.0	17.8	20.5	38.0	57	4,36
122-16-1	5	16	22.0	17.8	20.5	38.0	71	4,54
122-17-1	5	17	24.0	17.8	21.9	38.0	72	4,66
122-18-1	5	18	25.0	17.8	22.9	38.0	90	4,66
122-19-1	5	19	26.0	17.8	22.9	38.0	84	4,90
122-20-1	5	20	28.0	17.8	23.9	38.0	87	4,98
122-21-1	5	21	28.0	17.8	23.9	38.0	95	5,16
122-22-1	5	22	30.0	17.8	26.1	38.0	97	5,34
122-23-1	5	23	32.0	17.8	28.1	38.0	103	5,57
122-24-1	5	24	32.0	17.8	28.1	38.0	109	5,93
122-27-1	5	27	36.0	17.8	30.1	42.0	211	6,42
122-30-1	5	30	40.0	17.8	34.1	44.0	214	7,12
122-32-1	5	32	42.0	17.8	36.1	44.0	217	7,31
122-34-1	5	34	44.0	17.8	37.1	45.0	220	15,24
122-36-1	5	36	44.0	17.8	38.1	44.0	220	16,94



R			A mm	B mm	C mm	L mm	g	€
122A-10-1	5	5/16"	14.8	13.0	22.0	38.0	50	3,63
122A-11-1	5	11/32"	15.3	13.0	22.0	38.0	48	3,65
122A-12-1	5	3/8"	15.5	13.0	22.0	38.0	45	3,68
122A-14-1	5	7/16"	16.7	13.0	22.0	38.0	49	3,79
122A-16-1	5	1/2"	19.2	13.0	22.0	38.0	54	4,14
122A-18-1	5	9/16"	20.5	13.0	22.0	38.0	55	4,39
122A-20-1	5	5/8"	22.0	17.8	20.6	38.0	69	4,66
122A-22-1	5	11/16"	24.0	17.8	21.9	38.0	71	4,85
122A-24-1	5	3/4"	26.0	17.8	22.9	38.0	75	5,06
122A-26-1	5	13/16"	28.0	17.8	23.9	38.0	76	5,30
122A-28-1	5	7/8"	30.0	17.8	26.1	38.0	88	5,52
122A-30-1	5	15/16"	32.0	17.8	28.1	38.0	104	6,16
122A-34-1	5	1.1/16"	36.0	17.8	30.1	42.0	141	6,63
122A-38-1	5	1.3/16"	40.0	17.8	34.1	44.0	214	7,34
122A-40-1	5	1.1/4"	42.0	17.8	36.1	44.0	233	7,52



VASOS 1/2" HEX, SERIE LARGA

6 mm

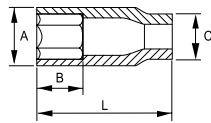

NOVEDAD

- Vasos en milímetros, diseño hexagonal
- Acero aleado Cromo Vanadio
- Mango estriado para girar los elementos de fijación de paso libre con los dedos
- Acabado cromado brillante
- Perfil NPP
- DIN 3120, DIN 3124

R			A mm	B mm	C mm	L mm	g	€
123-10-1	5	10	15.3	27.0	22.0	78.0	78	9,88
123-12-1	5	12	17.8	27.0	22.0	78.0	103	9,96
123-13-1	5	13	19.0	27.0	22.0	78.0	108	10,15
123-14-1	5	14	20.3	27.0	22.0	78.0	109	10,76
123-15-1	5	15	22.0	31.0	22.0	78.0	113	10,76
123-16-1	5	16	22.0	31.0	22.0	78.0	115	10,76
123-17-1	5	17	24.0	31.0	22.0	78.0	123	10,76
123-18-1	5	18	25.0	31.0	22.8	78.0	149	10,76
123-19-1	5	19	26.0	31.0	22.8	78.0	138	10,76
123-21-1	5	21	28.0	31.0	23.8	78.0	151	11,03
123-22-1	5	22	30.0	31.0	26.0	78.0	190	15,48
123-24-1	5	24	32.0	31.0	28.0	78.0	220	15,56

VASOS 1/2" TORX®

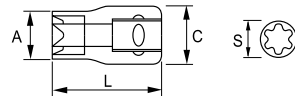

- DIN 3120

R			S mm	A mm	C mm	L mm	g	€
126-10-1	5	E-10	9.4	14.7	22.0	38.0	55	5,64
126-11-1	5	E-11	10.0	15.2	22.0	38.0	53	5,64
126-12-1	5	E-12	11.1	16.0	22.0	38.0	57	5,82
126-14-1	5	E-14	12.9	17.0	22.0	38.0	59	5,82
126-16-1	5	E-16	14.7	22.0	20.1	38.0	65	5,93
126-18-1	5	E-18	16.6	24.0	21.8	38.0	77	5,93
126-20-1	5	E-20	18.4	24.0	21.8	38.0	73	6,16
126-24-1	5	E-24	22.1	28.0	23.8	38.0	110	6,85

VASOS 1/2" BIHEX, SERIE LARGA

12 mm

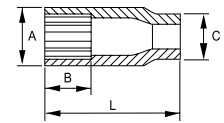

- Vasos en milímetros, diseño bi-hexagonal
- Acero aleado Cromo Vanadio
- Acabado cromado brillante
- Perfil NPP
- DIN 3120, DIN 3124

R			A mm	B mm	C mm	L mm	g	€
124-10-1	5	10	15.3	27.0	22.0	78.0	78	9,88
124-11-1	5	11	16.5	27.0	22.0	78.0	86	9,96
124-12-1	5	12	17.8	27.0	22.0	78.0	103	9,96
124-13-1	5	13	19.0	27.0	22.0	78.0	108	10,14
124-14-1	5	14	20.3	27.0	22.0	78.0	109	10,77
124-15-1	5	15	22.0	31.0	22.0	78.0	113	10,77
124-16-1	5	16	22.0	31.0	22.0	78.0	115	10,77
124-17-1	5	17	24.0	31.0	22.0	78.0	123	10,77
124-18-1	5	18	25.0	31.0	22.8	78.0	149	10,77
124-19-1	5	19	26.0	31.0	22.8	78.0	135	10,77
124-21-1	5	21	28.0	31.0	23.8	78.0	151	11,03
124-22-1	5	22	30.0	31.0	26.0	78.0	190	15,48
124-24-1	5	24	32.0	31.0	28.0	78.0	220	15,56
124-27-1	5	27	36.0	31.0	30.0	78.0	250	15,84
124-30-1	5	30	40.0	31.0	34.0	78.0	341	17,15
124-32-1	5	32	42.0	31.0	36.0	78.0	382	20,37

12 in

R			A mm	B mm	C mm	L mm	g	€
124A-18-1	5	9/16"	22.0	31.0	22.0	78.0	113	10,98
124A-20-1	5	5/8"	22.0	31.0	22.0	78.0	115	10,98
124A-22-1	5	11/16"	25.0	31.0	22.8	78.0	149	11,20
124A-24-1	5	3/4"	26.0	31.0	22.8	78.0	135	15,79
124A-26-1	5	13/16"	28.0	31.0	23.8	78.0	151	15,88

1



2



3



4



5



6



7



8



9



10



11



12





VASOS CON PUNTA 1/2"

PUNTA HEX



• DIN 3120 / ISO 1174

€			A mm	B mm	L mm	g	€
180-04-1	5	4	21.8	22	60	70	8,89
180-05-1	5	5	21.8	22	60	71	8,89
180-06-1	5	6	21.8	22	60	72	8,89
180-07-1	5	7	21.8	22	60	72	9,25
180-08-1	5	8	21.8	22	60	73	9,25
180-10-1	5	10	21.8	22	60	81	9,25
180-12-1	5	12	21.8	22	60	89	10,14
180-14-1	5	14	21.8	22	60	96	10,14
180-17-1	5	17	23.8	22	60	100	12,00
180-19-1	5	19	23.8	22	60	100	17,20

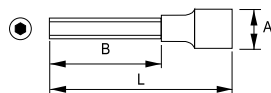

€			A mm	B mm	L mm	g	€
180-05X-1	5	5	21.8	62	100	89	9,88
180-06X-1	5	6	21.8	62	100	90	9,88
180-07X-1	5	7	21.8	62	100	91	10,14
180-08X-1	5	8	21.8	62	100	91	10,14
180-10X-1	5	10	21.8	62	100	109	10,14
180-12X-1	5	12	21.8	62	100	130	12,00

JUEGO 9 VASOS CON PUNTA 1/2" HEXAGONAL



- Juego de vasos con punta 1/2", 9 piezas
- Puntas hexagonales, mm
- Vasos: Acabado cromado brillante
- Puntas: fosfatadas
- DIN 3120 / ISO 1174
- Caja fabricada en polietileno de alta densidad y resistente

€				g	€
129-9H-4	1	9	55 x 200 x 160	1.080	43,58

180-04-1, 180-05-1, 180-06-1, 180-07-1, 180-08-1, 180-10-1, 180-12-1, 180-14-1, 180-17-1

PUNTA TORX®



• DIN 3120 / ISO 1174

€			S mm	A mm	B mm	L mm	g	€
183-20-1	5	T20	3.84	21.8	22	60	69	9,53
183-25-1	5	T25	4.40	21.8	22	60	69	9,53
183-27-1	5	T27	4.96	21.8	22	60	70	9,53
183-30-1	5	T30	5.49	21.8	22	60	70	9,53
183-40-1	5	T40	6.60	21.8	22	60	70	9,60
183-45-1	5	T45	7.77	21.8	22	60	70	9,60
183-50-1	5	T50	8.79	21.8	22	60	71	9,60
183-55-1	5	T55	11.17	21.8	22	60	76	12,18
183-60-1	5	T60	13.20	21.8	22	60	81	12,55

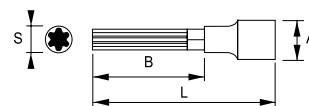

€			S mm	A mm	B mm	L mm	g	€
183-40X-1	5	T40	6.60	21.8	82	120	95	10,49
183-45X-1	5	T45	7.77	21.8	82	120	96	10,49
183-50X-1	5	T50	8.79	21.8	82	120	98	10,49
183-55X-1	5	T55	11.17	21.8	102	140	117	17,36

JUEGO 9 VASOS CON PUNTA TORX® 1/2"



- Juego de vasos con punta 1/2", 9 piezas
- Puntas TORX®
- Vasos: Acabado cromado brillante
- Puntas: fosfatadas
- DIN 3120 / ISO 1174
- Caja fabricada en polietileno de alta densidad y resistente

€				g	€
129-9T-4	1	9	55 x 200 x 160	1.140	44,68

183-20-1, 183-25-1, 183-27-1, 183-30-1, 183-40-1, 183-45-1, 183-50-1, 183-55-1, 183-60-1



PUNTA XZN



- DIN 3120 / ISO 1174

Q	📦	⊙	A mm	B mm	L mm	g	€
185-05-1	5	M 5	21.8	22	60	67	11,03
185-06-1	5	M 6	21.8	22	60	69	11,03
185-08-1	5	M 8	21.8	22	60	69	11,03
185-10-1	5	M 10	21.8	22	60	77	11,21
185-12-1	5	M 12	21.8	22	60	85	12,00
185-14-1	5	M 14	21.8	22	60	90	12,00
185-16-1	5	M 16	21.8	22	60	95	14,32

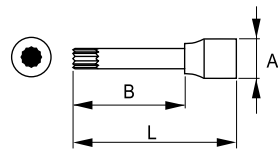

Q	📦	⊙	A mm	B mm	L mm	g	€
185-06X-1	5	M 6	21.8	62	100	87	11,21
185-08X-1	5	M 8	21.8	62	100	89	11,21
185-10X-1	5	M 10	21.8	62	100	105	12,00
185-12X-1	5	M 12	21.8	62	100	123	13,70

ACCESORIOS 1/2"

CARRACA TIPO PERA

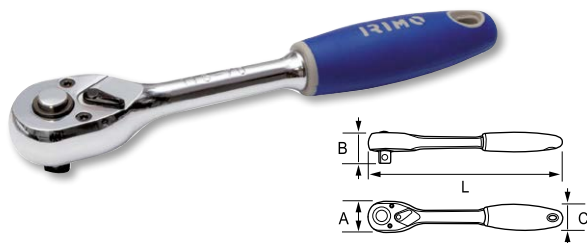

- 72 dientes / Ángulo de acción 5°
- Acabado cromado brillante
- Botón de rápida liberación
- Mango bicomponente
- DIN 3122/3120

Q	📦	A mm	B mm	C mm	L mm	g	€
125-70-1	5	42	41	36	262	591	17,96

VASOS 1/2" CON PUNTA TORX® INVOLABLE



- Vasos con punta 1/2" TORX® inviolable
- Acabado zinc fosfatado
- Envase individual

Q	📦	⊙	⊙	L mm	L1 mm	g	€
T49T30XL	1	TR30	1/2"	200	160	122	10,36
T49T40XL	1	TR40	1/2"	200	160	123	10,36
T49T45XL	1	TR45	1/2"	200	160	125	10,36
T49T70HL	1	TR70	1/2"	100	60	167	18,55
T49T80HL	1	TR80	1/2"	100	30	163	18,55

CARRACA REVERSIBLE REDONDA

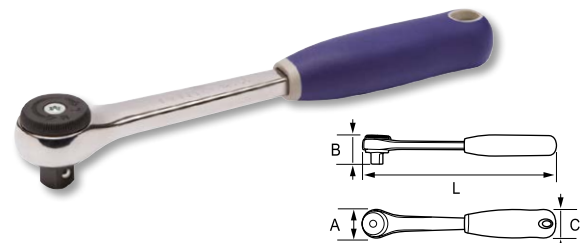

- 72 dientes / Ángulo de acción 5°
- Acabado cromado brillante
- DIN 3122, DIN 3120, ISO 3315, UNE 16512
- * Kit de reparación 125701

Q	📦	A mm	B mm	C mm	L mm	g	€
125501	1	39	41	30	251	614	52,26

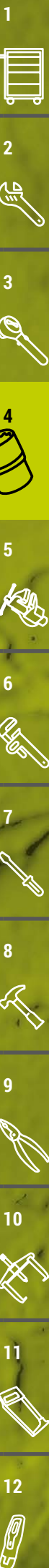



ACCESORIOS 1/2"

EXPOSITOR CON 12 CARRACAS DE 1/2"



- Carraca reversible
- 72 dientes / 5° de acción
- Acero de aleación de cromo vanadio
- Acabado cromado brillante
- Botón de rápida liberación
- Mango bicomponente
- Empuñadura acolchada de goma
- DIN 3122, DIN 3120
- Utilice el código 125-70-1 para hacer pedidos de carracas individuales

€					€
125-70-12DISP	1	12	225 x 295 x 220	7.852	215,61

JUEGO DE VASOS 1/2" EN RAIL, 10 piezas



- Juego de vasos de 1/2"
- Juego de vasos 10 piezas
- Vasos hexagonales, medidas métricas
- Acabado brillante cromado
- DIN 3120, DIN 3124, DIN 3122
- Presentación para colgar

€					€
129-10-4	5	10	360 x 90 x 15	800	43,68

121-10-1, 121-12-1, 121-13-1, 121-14-1, 121-16-1, 121-17-1, 121-19-1, 121-21-1, 121-22-1, 121-24-1

JUEGO DE 1/2" CARRACA + 10 VASOS



- Juego de vasos 12 piezas
- Vasos hexagonales, mm
- Acabado cromado brillante
- DIN 3120, DIN 3124, DIN 3122
- * Suministrado en display si se piden 8 unidades

€					€
129-12-4	8	12	330 x 100 x 50	1.600	43,26

125-70-1 125-23-1
 121-10-1, 121-12-1, 121-13-1, 121-14-1, 121-16-1, 121-17-1, 121-19-1, 121-21-1, 121-22-1, 121-24-1

ALARGADERAS

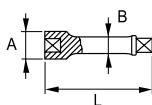

- DIN 3120, DIN 3122

€		A mm	B mm	L mm		€
125-22-1	5	22.4	15.7	75	120	7,97
125-23-1	5	22.4	15.7	125	193	8,37
125-25-1	5	22.4	15.7	250	380	10,31

MANGO ARTICULADO

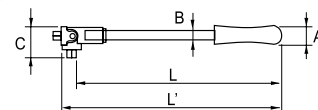

- DIN 3120

€		A mm	B mm	C mm	L' mm	L mm		€
125-52-1	5	35	12	40	375	355.0	692	27,39



BERBIQUÍ

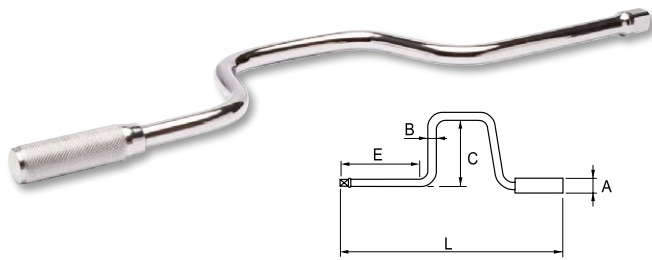

• DIN 3120, DIN 3122

Q	📦	A mm	B mm	C mm	E mm	L mm	g	€
125-49-1	5	31.0	12.7	75	152	420	575	19,03

MANGO CORREDIZO EN T

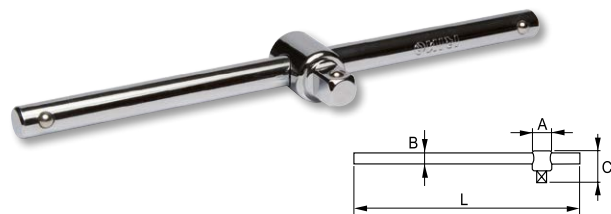

• DIN 3120, DIN 3122

Q	📦	A mm	B mm	C mm	L mm	g	€
125-42-1	5	23.5	13.5	45	250	272	13,80

CABEZA MANGO CORREDIZO

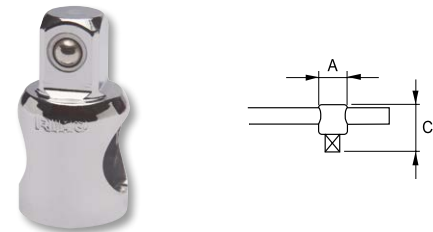

• DIN 3120

Q	📦	A mm	C mm	g	€
125-43-1	5	24.0	44	73	6,55

REDUCTOR



• Adaptador reductor 1/2" a 3/8"
• DIN 3120, DIN 3122

Q	📦	A mm	L mm	g	€
125-46-1	5	22.0	35.5	45	9,43

AUMENTADOR



• Aumentador de 1/2" a 3/4"
• DIN 3120, DIN 3122

Q	📦	A mm	L mm	g	€
125-44-1	5	25.0	50.0	140	11,38

MANGO ACODADO

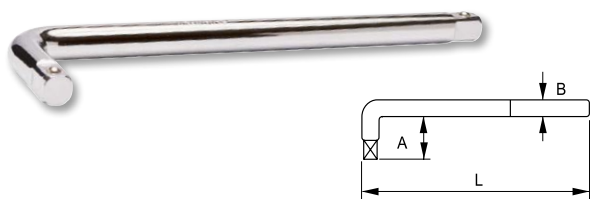

• DIN 3120, DIN 3122

Q	📦	A mm	B mm	L mm	g	€
125-60-1	5	46	14	250	456	10,14

VASO PARA BUJÍAS

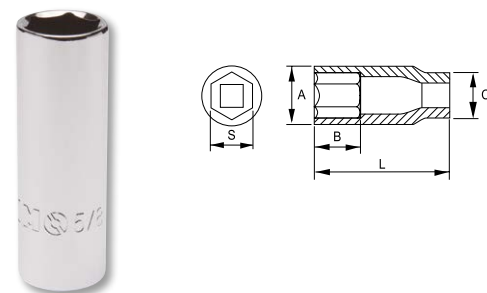

Q	📦	S mm	A mm	B mm	C mm	L mm	g	€
125-53-1	5	5/8" - 16	22.0	32.0	22.0	65.0	90	9,14
125-54-1	5	13/16" - 21	28.0	31.0	24.0	65.0	146	11,49

1



2



3



4



5



6



7



8



9



10



11



12





ACCESORIOS 1/2"

ARTICULACIÓN UNIVERSAL



- DIN 3120, DIN 3122

R	📦	A mm	L mm	g	€
125-40-1	5	23.8	72.0	146	17,80

VASO PORTA PUNTAS 5/16"



- Cuadrado hembra 1/2" a hex hembra 5/16"
- DIN 3120

R	📦	🌀	A mm	L mm	g	€
125-48-1	5	5/16"	17.0	38.5	56	6,00

JUEGO VASOS 1/2"

JUEGO VASOS 1/2", 23 piezas



- Juego de vasos 23 piezas
- Vasos Hex mm
- Acabado cromado brillante
- DIN 3120, DIN 3124 y DIN 3122
- Caja fabricada en polietileno de alta densidad y resistente
- Cierres metálicos

R	📦	📦	📦	g	€
129-23-4	1	23	320x250x75	3.500	81,32

125-70-1		125-43-1	
----------	--	----------	--

125-25-1		125-23-1	
----------	--	----------	--

125-40-1	
----------	--

121-08-1, 121-10-1, 121-12-1, 121-13-1, 121-14-1, 121-16-1, 121-17-1, 121-19-1, 121-20-1, 121-21-1, 121-22-1, 121-23-1, 121-24-1, 121-26-1, 121-27-1, 121-28-1, 121-30-1, 121-32-1

JUEGO DE VASOS Y LLAVES 1/2", 33 piezas



- Juego de vasos y llaves de 33 piezas
- Vasos hexagonales, mm
- Acabado cromado brillante
- DIN 3120, DIN 3124, DIN 3122, ISO 10102
- Caja fabricada en polietileno de alta densidad y resistente
- Caja con cierres metálicos

R	📦	📦	📦	g	€
129-33W-4	1	33	320x250x75	5.020	108,93

125-70-1		125-43-1	
----------	--	----------	--

125-25-1		125-23-1	
----------	--	----------	--

125-40-1	
----------	--

25-08-1, 25-09-1, 25-10-1, 25-11-1, 25-12-1, 25-13-1, 25-14-1, 25-15-1, 25-17-1, 25-19-1

121-08-1, 121-10-1, 121-12-1, 121-13-1, 121-14-1, 121-16-1, 121-17-1, 121-19-1, 121-20-1, 121-21-1, 121-22-1, 121-23-1, 121-24-1, 121-26-1, 121-27-1, 121-28-1, 121-30-1, 121-32-1



**JUEGO VASOS MIXTO 1/4"-1/2",
58 piezas**

1/4" 1/2" mm



- Juego de vasos 58 piezas
- Vasos Hex mm
- Acabado cromado brillante
- DIN 3120, DIN 3124 y DIN 3122
- Caja fabricada en polietileno de alta densidad y resistente
- Cierres metálicos

Artículo	Caja	Piezas	Dimensiones	Peso	Precio
129-58-4	1	58	380x280x80	4.750	105,30
105-50-1		105-70-1			
105-42-1		105-40-1			
105-22-1		105-24-1			
125-70-1		125-43-1			
125-25-1		125-40-1			
125-23-1					
101-04-1, 101-045-1, 101-05-1, 101-055-1, 101-06-1, 101-07-1, 101-08-1, 101-09-1, 101-10-1, 101-11-1, 101-12-1, 101-13-1					
121-08-1, 121-10-1, 121-12-1, 121-13-1, 121-14-1, 121-16-1, 121-17-1, 121-19-1, 121-20-1, 121-21-1, 121-22-1, 121-23-1, 121-24-1, 121-26-1, 121-27-1, 121-28-1, 121-30-1, 121-32-1					
040001, 040011, 040021					
475-PH1-1, 475-PH2-1, 475-PH3-1					
475-PZ1-1, 475-PZ2-1, 475-PZ3-1					
475-3-1, 475-4-1, 475-5.5-1					
475-H3-1, 475-H4-1, 475-H5-1, 475-H6-1					

**JUEGO VASOS MIXTO 1/4"-1/2",
HEXAGONALES, 53 piezas**

1/4" 1/2" in



- Juego de vasos 53 piezas
- Vasos hexagonales, mm
- Acabado cromado brillante
- DIN 3120, DIN 3124, DIN 3122
- Caja fabricada en polietileno de alta densidad y resistente
- Caja con cierres metálicos

Artículo	Caja	Piezas	Dimensiones	Peso	Precio
129A-53-4	1	53	380x280x80	4.750	105,55
105-48-1		105-70-1			
105-42-1		105-50-1			
105-22-1		105-24-1			
105-40-1		125-70-1			
125-25-1		125-43-1			
125-23-1		125-40-1			
101A-05-1, 101A-06-1, 101A-07-1, 101A-08-1, 101A-09-1, 101A-10-1, 101A-11-1, 101A-12-1, 101A-14-1, 101A-16-1, 101A-18-1					
122A-10-1, 122A-11-1, 122A-12-1, 122A-14-1, 122A-16-1, 122A-18-1, 122A-20-1, 122A-22-1, 122A-24-1, 122A-26-1, 122A-28-1, 122A-30-1, 122A-34-1, 122A-38-1, 122A-40-1					
040001, 040011, 040021					
475-PH1-1, 475-PH2-1, 475-PH3-1					
475-PZ1-1, 475-PZ2-1, 475-PZ3-1					
475-3-1, 475-4-1, 475-5.5-1					
1/4" Hex 1/8", 5/32", 3/16", 7/32" AF					

1



2



3



4



5



6



7



8



9



10



11



12





JUEGO VASOS 1/2"

JUEGO VASOS MIXTO 1/4"-1/2", 108 piezas



- Juego de vasos de 108 piezas
- Vasos hexagonales, mm
- Acabado cromado brillante
- DIN 3120, DIN 3124, DIN 3122
- Caja fabricada en polietileno de alta densidad y resistente
- Caja con cierres metálicos

R	📦	📦	📦	📦	€
129-108-4	1	108	380x280x80	7.100	149,24
105-48-1		105-70-1			
125-42-1		105-50-1			
105-22-1		105-40-1			
105-24-1		125-70-1			
125-48-1		125-43-1			
125-25-1		125-23-1			
125-40-1					
101-04-1, 101-045-1, 101-05-1, 101-055-1, 101-06-1, 101-07-1, 101-08-1, 101-09-1, 101-10-1, 101-11-1, 101-12-1, 101-13-1, 101-14-1		1/4"			
103-06-1, 103-07-1, 103-08-1, 103-09-1, 103-10-1, 103-12-1, 103-13-1		1/4"			
106-04-1, 106-05-1, 106-06-1, 106-07-1, 106-08-1					
121-10-1, 121-11-1, 121-12-1, 121-13-1, 121-14-1, 121-15-1, 121-16-1, 121-17-1, 121-18-1, 121-19-1, 121-20-1, 121-21-1, 121-22-1, 121-24-1, 121-27-1, 121-30-1, 121-32-1		1/2"			
126-10-1, 126-11-1, 126-12-1, 126-14-1, 126-16-1, 126-18-1, 126-20-1, 126-24-1					
124-14-1, 124-15-1, 124-17-1, 124-19-1, 124-22-1		1/2"			
125-53-1, 125-54-1					
107-T08-1, 107-T10-1, 107-T15-1, 107-T20-1, 107-T25-1, 107-T27-1, 107-T30-1					
107-H3-1, 107-H4-1, 107-H5-1, 107-H6-1					
107-PH1-1, 107-PH2-1					
107-PZ1-1, 107-PZ2-1					
107-0840-1, 107-1055-1, 107-1280-1					
040001, 040011, 040021					
045801, 045811, 045821					
470-10.0-1, 470-12.0-1, 470-8.0-1					
470-H10-1, 470-H7-1, 470-H8-1					
470-PH3-1, 470-PH4-1					
470-T40-1, 470-T45-1, 470-T50-1, 470-T55-1, 470-T60-1					
470-PZ3-1, 470-PZ4-1					

JUEGO VASOS MIXTO 1/4"-1/2", HEXAGONALES, 103 piezas



- Juego de vasos, 103 piezas
- Vasos hexagonales, pulgadas
- Acabado cromado brillante
- DIN 3120, DIN 3124, DIN 3122
- Caja fabricada en polietileno de alta densidad y resistente
- Caja con cierres metálicos

R	📦	📦	📦	📦	€
129A-103-4	1	103	380x280x80	7.000	151,55
105-40-1		105-70-1			
105-42-1		105-50-1			
105-22-1		105-24-1			
125-70-1		125-43-1			
125-25-1		125-40-1			
125-23-1		125-48-1			
101A-05-1, 101A-06-1, 101A-07-1, 101A-08-1, 101A-10-1, 101A-11-1, 101A-12-1, 101A-14-1, 101A-16-1, 101A-18-1		1/4"			
103A-06-1, 103A-08-1, 103A-09-1, 103A-10-1, 103A-11-1, 103A-12-1, 103A-14-1, 103A-16-1		1/4"			
106-04-1, 106-05-1, 106-06-1, 106-07-1, 106-08-1					
122A-12-1, 122A-14-1, 122A-16-1, 122A-18-1, 122A-20-1, 122A-22-1, 122A-24-1, 122A-26-1, 122A-28-1, 122A-40-1		1/2"			
124A-18-1, 124A-20-1, 124A-22-1, 124A-24-1, 124A-26-1		1/2"			
126-10-1, 126-11-1, 126-12-1, 126-14-1, 126-16-1, 126-18-1, 126-20-1, 126-24-1					
125-53-1, 125-54-1					
107-T08-1, 107-T09-1, 107-T10-1, 107-T15-1, 107-T20-1, 107-T25-1, 107-T27-1, 107-T30-1					
107A-4-1, 107A-5-1, 107A-6-1, 107A-7-1					
107-PH1-1, 107-PH2-1					
107-PZ1-1, 107-PZ2-1					
107-0840-1, 107-1055-1, 107-1280-1					
040001, 040011, 040021					
470-T40-1, 470-T45-1, 470-T50-1, 470-T55-1, 470-T60-1					
470-10.0-1, 470-12.0-1, 470-8.0-1					
470-H7-1, 470-H8-1, 470-H10-1, 470-H12-1, 470-H14-1					
470-PH3-1, 470-PH4-1					
470-PZ3-1, 470-PZ4-1					



**JUEGO VASOS MIXTO 1/4"-1/2",
101 piezas**



- Juego de vasos 101 piezas
- Vasos Hex mm
- Acabado cromado brillante
- DIN 3120, DIN 3124 y DIN 3122
- Caja fabricada en polietileno de alta densidad y resistente
- Caja con cierres metálicos

Artículo	Cantidad	Dimensiones	Peso	Precio
129-101-4	1	101	380x280x80	7.000 €
105-48-1		105-70-1		
125-42-1		105-50-1		
105-22-1		105-40-1		
105-24-1		105-28-1		
125-70-1		125-43-1		
125-25-1		125-40-1		
125-23-1		125-48-1		
101-04-1, 101-045-1, 101-05-1, 101-055-1, 101-06-1, 101-07-1, 101-08-1, 101-09-1, 101-10-1, 101-11-1, 101-12-1, 101-13-1, 101-14-1				1/4"
103-06-1, 103-07-1, 103-08-1, 103-10-1, 103-11-1, 103-12-1, 103-13-1, 103-14-1				1/4"
121-08-1, 121-10-1, 121-12-1, 121-13-1, 121-14-1, 121-16-1, 121-17-1, 121-19-1, 121-20-1, 121-21-1, 121-22-1, 121-23-1, 121-24-1, 121-26-1, 121-27-1, 121-28-1, 121-30-1, 121-32-1				1/2"
124-13-1, 124-17-1, 124-19-1, 124-22-1				1/2"
107-T08-1, 107-T10-1, 107-T15-1, 107-T20-1, 107-T25-1, 107-T30-1				
107-H3-1, 107-H 4-1, 107-H5-1, 107-H6-1				
107-PH1-1, 107-PH2-1				
107-PZ1-1, 107-PZ2-1				
107-0840-1, 107-1055-1, 107-1280-1				
040001, 040011, 040021				
475-H3-1, 475-H4-1, 475-H5-1				
475-T10-1, 475-T15-1, 475-T20-1, 475-T25-1, 475-T27-1, 475-T30-1				
470-8.0-1, 470-10.0-1				
470-H6-1, 470-H7-1, 470-H8-1, 470-H10-1				
470-T30-1, 470-T40-1, 470-T45-1, 470-T50-1, 470-T55-1				

**JUEGO VASOS 1/4" - 3/8" - 1/2"
HEXAGONALES, MM, 172 piezas**



- Vasos hexagonales, mm
- Acabado cromado brillante
- DIN 3120, DIN 3124, DIN 3122
- Caja fabricada en polietileno de alta densidad y resistente
- Caja con cierres metálicos

Artículo	Cantidad	Dimensiones	Peso	Precio
129-172-4	1	172	100x500x370	9.650 €
105-48-1		105-70-1		
105-42-1		105-50-1		
105-22-1		105-40-1		
105-24-1		115-70-1		
115-22-1		115-48-1		
115-40-1				
125-70-1		125-43-1		
125-25-1		125-40-1		
125-23-1		125-48-1		
101-04-1, 101-045-1, 101-05-1, 101-055-1, 101-06-1, 101-07-1, 101-08-1, 101-09-1, 101-10-1, 101-11-1, 101-12-1, 101-13-1, 101-14-1				1/4"
103-04-1, 103-05-1, 103-06-1, 103-07-1, 103-08-1, 103-09-1, 103-10-1				1/4"
106-04-1, 106-05-1, 106-06-1, 106-07-1, 106-08-1				
112-10-1, 112-11-1, 112-12-1, 112-13-1, 112-14-1, 112-15-1, 112-16-1, 112-17-1, 112-18-1, 112-19-1				3/8"
113-10-1, 113-11-1, 113-12-1, 113-13-1, 113-14-1, 113-15-1				3/8"
126-20-1, 126-24-1				
125-53-1, 125-54-1				
121-10-1, 121-11-1, 121-12-1, 121-13-1, 121-14-1, 121-15-1, 121-16-1, 121-17-1, 121-18-1, 121-19-1, 121-20-1, 121-21-1, 121-22-1, 121-24-1, 121-27-1, 121-30-1, 121-32-1				1/2"
107-T08-1, 107-T09-1, 107-T10-1, 107-T15-1, 107-T20-1, 107-T25-1, 107-T27-1, 107-T30-1				
107-H3-1, 107-H4-1, 107-H5-1, 107-H6-1				
107-PH0-1, 107-PH1-1, 107-PH2-1				
107-PZ0-1, 107-PZ1-1, 107-PZ2-1				
Vasos con punta 1/4": 4.5-5-6-5-7 mm				
Vasos con punta 1/4": T8H-T9H-T10H-T15H-T20H-T25H-T27H-T30H				
Vasos 3/8": E10-E11-E12-E14-E16-E18				
Vaso para bujias 3/8": 16 mm				
Vasos largos 1/2" (6 PT): 16-17-18-19-22 mm				1/2"
Llaves hexagonales: 1.5-2-2.5-3-4-5-6 mm				
20 piezas de 1/4" - Puntas 25 mm: T8-T9-T10-T15-T20-T25-T27-T30-T40-T45 / H3-H4-H5-H6 / PH0-PH1-PH2 / PZ0-PZ1-PZ2				
24 piezas de 8 mm - Puntas 30 mm: T40-T45-T50-T55-T60-T70 / H7-H8-H10-H12-H14 / PH3-PH4 / PZ3-PZ4 / SL8-SL10-SL12				





JUEGO VASOS 1/2"

JUEGO VASOS 1/4" - 3/8" - 1/2" HEXAGONALES, MM



- Juego de vasos de 164 piezas
- Vasos hexagonales, mm
- Acabado cromado brillante
- DIN 3120, DIN 3124, DIN 3122
- Caja fabricada en polietileno de alta densidad y resistente
- Caja con dos cierres extra para mayor seguridad en el transporte

R	📦	📦	📦	📦	€
149-164-4	1	164	490x370x100	12.919	314,32
105-48-1			105-70-1		
105-24-1			105-50-1		
105-22-1			105-40-1		
115-70-1			115-40-1		
115-20-1			115-24-1		
115-44-1			115-46-1		
115-48-1			125-70-1		
125-23-1			125-25-1		
125-46-1			125-40-1		
601-200-1			612-160-1		
475R-1/4-30			48-9-H		
475-5-1					
101-04-1, 101-05-1, 101-055-1, 101-06-1, 101-07-1, 101-08-1, 101-09-1, 101-10-1, 101-11-1, 101-12-1			1/4"		
103-04-1, 103-05-1, 103-06-1, 103-07-1, 103-08-1, 103-09-1, 103-10-1, 103-11-1, 103-12-1			1/4"		
112-08-1, 112-09-1, 112-10-1, 112-11-1, 112-12-1, 112-13-1, 112-14-1, 112-15-1, 112-16-1, 112-17-1, 112-18-1, 112-19-1			3/8"		
113-08-1, 113-09-1, 113-10-1, 113-11-1, 113-12-1, 113-13-1, 113-14-1, 113-15-1, 113-17-1, 113-19-1			3/8"		
121-14-1, 121-17-1, 121-18-1, 121-19-1, 121-20-1, 121-21-1, 121-22-1, 121-24-1, 121-27-1, 121-30-1, 121-32-1			1/2"		
124-12-1, 124-13-1, 124-14-1, 124-15-1, 124-17-1, 124-18-1, 124-19-1, 124-21-1, 124-22-1			1/2"		
167-17-1, 167-19-1, 167-21-1, 167-23-1			1/2"		
18-12-1, 18-13-1, 18-14-1					
25-08-1, 25-09-1, 25-10-1, 25-11-1, 25-12-1, 25-13-1, 25-14-1, 25-17-1, 25-18-1, 25-19-1					
475-T10-1, 475-T15-1, 475-T20-1, 475-T25-1, 475-T27-1, 475-T30-1, 475-T40-1					
475-TR10-1, 475-TR15-1, 475-TR20-1, 475-TR25-1, 475-TR27-1, 475-TR30-1, 475-TR40-1					
Vasos para bujías 3/8": 16-21 mm					
Vasos con punta 3/8": 3-4-5-6 mm					
Vasos con punta 3/8": PH1-PH2					
Vasos con punta 3/8": PZ1-PZ2					
Vasos con punta 3/8": TR10-TR15-TR20-TR25-TR30-TR40					
Vasos 3/8" TORX®: E8, E10, E11, E12, E14, E16, E18, E20					

VASOS 3/4"

VASOS 3/4"

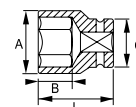

- Vasos en milímetros, diseño hexagonal
- Acero aleado Cromo Vanadio
- Acabado cromado brillante
- Perfil NPP
- DIN 3124, DIN 3120

R	📦	📏	A mm	B mm	C mm	L mm	📦	€
131-19-1	1	19	30	12	36	50	200	10,34
131-21-1	1	21	32	12	36	50	215	10,49
131-22-1	1	22	33	12	36	50	215	10,64
131-23-1	1	23	34	14	36	50	215	11,01
131-24-1	1	24	34	16	36	50	215	11,40
131-25-1	1	25	38	16	36	50	220	11,40
131-26-1	1	26	38	16	36	52	220	11,79
131-27-1	1	27	38	18	36	52	240	11,79
131-28-1	1	28	38	18	36	52	250	12,36
131-29-1	1	29	42	18	38	52	260	12,74
131-30-1	1	30	42	20	38	52	275	13,21
131-32-1	1	32	44	22	38	52	310	13,51
131-33-1	1	33	46	22	38	55	340	14,18
131-34-1	1	34	46	22	38	57	330	14,48
131-35-1	1	35	48	24	42	57	380	14,74
131-36-1	1	36	50	24	42	57	415	15,61
131-38-1	1	38	52	26	44	57	455	16,87
131-40-1	1	40	56	27	44	63	505	17,82
131-41-1	1	41	56	27	44	63	545	18,60
131-42-1	1	42	58	27	44	63	600	19,72
131-46-1	1	46	62	30	44	68	650	21,94
131-50-1	1	50	68	33	44	72	755	24,99
131-55-1	1	55	75	36	48	75	1.000	30,08
131-60-1	1	60	80	39	48	77	1.100	33,44



VASOS 3/4" BIHEX

12 mm

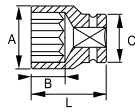

- Vasos en milímetros, diseño bi-hexagonal
- Acero aleado Cromo Vanadio
- Acabado cromado brillante
- Perfil NPP
- DIN 3120, DIN 3124

R	Icono	A mm	B mm	C mm	L mm	g	€	
131B-19-2	1	19	30	12	36	50	200	10,34
131B-21-2	1	21	32	12	36	50	215	10,49
131B-22-2	1	22	33	12	36	50	215	10,64
131B-23-2	1	23	34	14	36	50	215	11,01
131B-24-2	1	24	34	16	36	50	215	11,40
131B-26-2	1	26	38	16	36	52	220	11,79
131B-27-2	1	27	38	18	36	52	240	11,79
131B-29-2	1	29	42	18	38	52	260	12,74
131B-30-2	1	30	42	20	38	52	275	13,21
131B-32-2	1	32	44	22	38	52	310	13,51
131B-35-2	1	35	48	24	42	57	380	14,74
131B-36-2	1	36	50	24	42	57	415	15,61
131B-38-2	1	38	52	26	44	57	455	16,87
131B-41-2	1	41	56	27	44	63	545	18,60
131B-46-2	1	46	56	27	44	63	545	21,94
131B-50-2	1	50	67	29	46	72	715	24,99

12 in

R	Icono	A mm	B mm	C mm	L mm	g	€	
132A-28-1	1	7/8"	33	12	36	50	215	10,92
132A-30-1	1	15/16"	35	16	36	50	215	11,49
132A-32-1	1	1"	38	16	36	52	200	11,59
132A-34-1	1	1.1/16"	38	18	36	54	240	11,97
132A-36-1	1	1.1/8"	42	18	38	55	280	12,55
132A-40-1	1	1.1/4"	44	22	38	55	310	13,89
132A-42-1	1	1.5/16"	46	22	38	57	340	15,03
132A-44-1	1	1.3/8"	48	24	42	57	380	15,33
132A-46-1	1	1.7/16"	50	24	42	57	415	15,90
132A-48-1	1	1.1/2"	52	26	44	57	455	17,24
132A-52-1	1	1.5/8"	56	27	44	63	545	18,88
132A-54-1	1	1.11/16"	58	27	44	63	600	20,03
132A-60-1	1	1.7/8"	65	30	44	68	700	25,67
132A-64-1	1	2"	68	33	44	72	755	25,67

ACCESORIOS 3/4"

CABEZA DE CARRACA

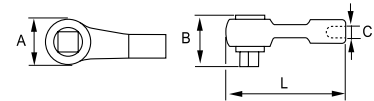

- 24 dientes
- Acabado cromado brillante
- Botón de rápida liberación
- Mango bicomponente
- DIN 3120, DIN 3122

R	Icono	A mm	B mm	C mm	L mm	g	€
135-70-1	1	65	61.5	20	155	1.360	69,12

ALARGADERAS

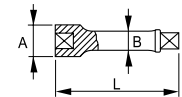

- Sistema de retención por bola

R	Icono	A mm	B mm	L mm	g	€
135-21-1	1	36	23	125	515	18,76
135-22-1	1	36	23	200	725	22,03
135-24-1	1	36	23	400	1.350	29,41

MANERAL

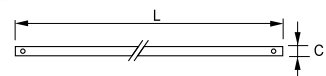

- Mango de carraca

R	Icono	C mm	L mm	g	€
135-85-1	1	20	450	1.100	14,79

MANGO CORREDIZO EN T

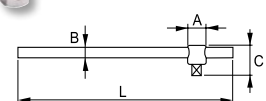

- Sistema de retención por bola

R	Icono	A mm	B mm	C mm	L mm	g	€
135-42-1	1	36	20	60	450	1.335	33,82

1



2



3



4



5



6



7



8



9



10



11



12





ACCESORIOS 3/4"

CABEZA MANGO CORREDIZO

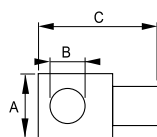

- Sistema de retención por bola

R	📦	A mm	B mm	C mm	g	€
135-43-1	1	35	20.5	60	235	13,21

ARTICULACIÓN UNIVERSAL

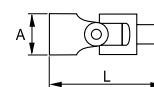

- Sistema de retención por bola

R	📦	A mm	L mm	g	€
135-40-1	1	40	108	540	49,33

REDUCTOR

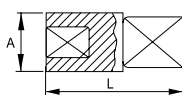

- Adaptador reductor 3/4" a 1/2"
- Sistema de retención por bola

R	📦	A mm	L mm	g	€
135-46-1	1	36	54	260	15,82

MANGO ARTICULADO

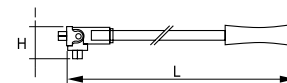

- Sistema de retención por bola

R	📦	H mm	L mm	g	€
135-52-1	1	40	450	1.700	41,48

JUEGO VASOS 3/4"

JUEGO VASOS 3/4", HEXAGONALES, MM, 17 piezas



- Juego de vasos 17 piezas
- Vasos hexagonales, mm
- Acero aleado Cromo Vanadio
- Acabado cromado brillante
- DIN 3120, DIN 3124, DIN 3122
- Caja fabricada en polietileno de alta densidad y resistente
- Caja con cierres metálicos
- Referencia caja de repuesto: SP-106S-BOX17
- Referencia dos cierres de recambio: SP104S

R	📦	📏	📦	g	€
139-17-4	1	17	475x295x100	12.500	207,82

135-70-1		135-24-1	
----------	--	----------	--

135-22-1		135-43-1	
----------	--	----------	--

135-85-1	
----------	--

131-22-1, 131-24-1, 131-27-1, 131-30-1, 131-32-1, 131-33-1, 131-34-1, 131-36-1, 131-38-1, 131-41-1, 131-46-1, 131-50-1		
--	--	--

JUEGO VASOS 3/4", HEXAGONALES, MM, 21 piezas



- Juego de vasos de 21 piezas
- Vasos hexagonales, mm
- Acero aleado Cromo Vanadio
- Acabado cromado brillante
- DIN 3120, DIN 3124, DIN 3122
- Caja fabricada en polietileno de alta densidad y resistente
- Caja con cierres metálicos
- Referencia caja de recambio: SP-106S-BOX21

R	📦	📏	📦	g	€
139-21-4	1	21	475x295x100	11.900	242,70

135-70-1		135-24-1	
----------	--	----------	--

135-22-1		135-43-1	
----------	--	----------	--

135-85-1	
----------	--

131-19-1, 131-21-1, 131-22-1, 131-23-1, 131-24-1, 131-26-1, 131-27-1, 131-29-1, 131-30-1, 131-32-1, 131-35-1, 131-36-1, 131-38-1, 131-41-1, 131-46-1, 131-50-1		
--	--	--



JUEGO VASOS 3/4", BIHEXAGONALES, MM, 21 piezas

3/4" mm



- Juego de vasos de 21 piezas
- Vasos bihexagonales, mm
- Acero aleado Cromo Vanadio
- Acabado cromado brillante
- DIN 3120, DIN 3124, DIN 3122
- Caja fabricada en polietileno de alta densidad y resistente
- Caja con cierres metálicos
- Referencia caja de recambio: SP-106S-BOX21

Icono	Icono	Icono	Icono	Icono	€
139-21B-4	1	21	475x295x100	11.900	242,70
135-70-1		135-24-1			
135-22-1		135-43-1			
135-85-1					
131B-19-2, 131B-21-2, 131B-22-2, 131B-23-2, 131B-24-2, 131B-26-2, 131B-27-2, 131B-29-2, 131B-30-2, 131B-32-2, 131B-35-2, 131B-36-2, 131B-38-2, 131B-41-2, 131B-46-2, 131B-50-2					

VASOS IMPACTO 3/8"

VASOS DE IMPACTO 3/8" HEX

6 mm

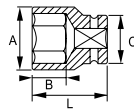

- Vasos en milímetros, diseño hexagonal
- UNE 16507, ISO 2725, DIN 3129

Icono	Icono	Icono	A mm	B mm	C mm	L mm	g	€
160-07-1	1	7	12.6	13	19	32	39	2,52
160-08-1	1	8	14	13	19	32	39	2,52
160-10-1	1	10	15.8	13	19	32	40	2,52
160-11-1	1	11	16.9	13	19	32	41	2,52
160-12-1	1	12	18.2	13	19	32	41	2,52
160-13-1	1	13	19.5	13	22	32	54	2,77
160-14-1	1	14	20.5	13	22	32	54	2,77
160-15-1	1	15	22	16	22	32	54	2,77
160-16-1	1	16	24	16	22	32	57	3,26
160-17-1	1	17	25	17	22	34	67	3,26
160-18-1	1	18	26	17	22	34	67	3,58
160-19-1	1	19	28	17	22	34	71	3,58
160-20-1	1	20	28	17	22	34	79	3,58
160-21-1	1	21	30	17	22	34	80	3,91
160-24-1	1	24	34	17	22	34	102	4,67

VASOS DE IMPACTO 3/8" HEX, SERIE LARGA

6 mm

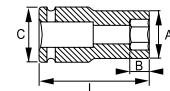

Icono	Icono	Icono	A mm	B mm	C mm	L mm	g	€
161-10-1	1	10	15.9	10	19	63	77	7,82
161-13-1	1	13	19.7	10	19	63	96	8,30
161-17-1	1	17	24.5	11	22	63	184	9,77

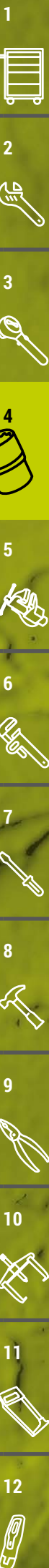



ACCESORIOS 3/8"

ALARGADERAS



- DIN 16503, ISO 1174

R		A mm	B mm	L mm	g	€
162-00-1	1	19	12.5	75	99	4,93
162-02-1	1	19	12.5	150	159	6,69

JUNTA CARDAN



- DIN 16503, ISO 1174

R		A mm	L mm	g	€
162-50-1	1	22	50	124	12,66

REDUCTOR

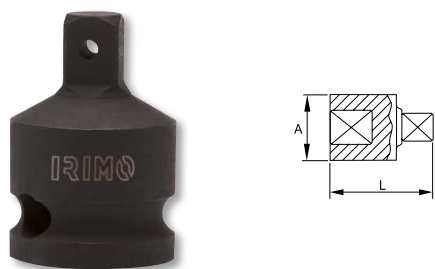

- Reductor de 3/8" a 1/4"
- DIN 16503, ISO 1174
- Dadas las condiciones especiales de este producto, no está garantizado contra la rotura del cuadrado macho

R		A mm	L mm	g	€
162-65-1	1	19	28	57	6,69

AUMENTADOR

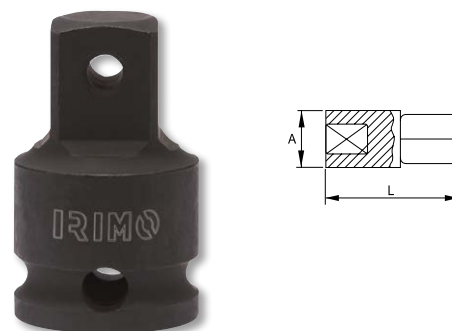

- Aumentador de 3/8" a 1/2"
- DIN 16503, ISO 1174

R		A mm	L mm	g	€
162-60-1	1	22	36	96	8,65

ANILLAS DE SEGURIDAD



- Anillas de seguridad 3/8"

R				g	€
162931	1	3/8"	7-12	2	4,93
162941	1	3/8"	13-24	2	4,93



VASOS IMPACTO 1/2"

VASOS DE IMPACTO 1/2" HEX

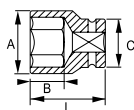

- Vasos en milímetros, diseño hexagonal
- UNE 16507, ISO 2725, DIN 3129

€			A mm	B mm	C mm	L mm	g	€
167-08-1	1	8	15	15	25	38	84	4,17
167-10-1	1	10	17.5	15	25	38	89	4,14
167-12-1	1	12	19	15	25	38	94	4,51
167-13-1	1	13	20	15	25	38	94	4,71
167-14-1	1	14	22	15	25	38	94	4,95
167-15-1	1	15	23	15	25	38	134	5,05
167-16-1	1	16	24	15	25	38	134	5,27
167-17-1	1	17	26	15	30	38	134	5,42
167-18-1	1	18	27	15	30	38	134	5,42
167-19-1	1	19	28	17.5	30	38	134	5,69
167-20-1	1	20	29	17.5	30	38	137	5,78
167-21-1	1	21	30	17.5	30	38	149	5,99
167-22-1	1	22	32	17.5	30	38	149	6,19
167-23-1	1	23	34	18	30	40	149	6,48
167-24-1	1	24	34	18	30	40	179	6,89
167-26-1	1	26	36	22	30	42	189	7,16
167-27-1	1	27	38	22	30	42	204	7,45
167-30-1	1	30	42	22	30	44	234	8,26
167-32-1	1	32	44	22	40	44	282	8,48
167-34-1	1	34	46	22	40	48	406	10,12
167-36-1	1	36	48	22	40	48	467	10,43
167-38-1	1	38	50	23	40	48	480	13,29
167-41-1	1	41	50	24	42	48	495	13,89

JUEGO VASOS DE IMPACTO 1/2", 9 piezas



NOVEDAD



- Aleación de acero de cromo molibdeno de alto rendimiento
- Acabado fosfatado
- Para usar con máquinas
- Para usar con muelle de seguridad 169921 o 169931
- Perfil Dynamic-Drive para proteger las tuercas
- UNE 16507, DIN 3129, ISO 2725
- Caja fabricada en polietileno de alta densidad y resistente

€				g	€
167-9-4	1	9	58x170x210	1.610	56,65
167-17-1, 167-19-1, 167-22-1, 167-24-1, 167-27-1					1/2"
169-01-1			169-25-1		
169-65-1			169-60-1		

JUEGO VASOS DE IMPACTO 1/2", 10 piezas



- Juego con 10 vasos de impacto
- Vasos hexagonales
- Acabado fosfatado
- ISO 2725, DIN 3129
- Caja fabricada en polietileno de alta densidad y resistente

€				g	€
167-10-4	1	10	200x160x52	1.425	36,41
167-10-1, 167-13-1, 167-14-1, 167-16-1, 167-17-1, 167-18-1, 167-19-1, 167-21-1, 167-22-1, 167-24-1					1/2"





VASOS IMPACTO 1/2"

JUEGO VASOS DE IMPACTO 1/2", 11 piezas



1/2" mm

- Aleación de acero de cromo molibdeno de alto rendimiento
- Acabado fosfatado
- Para usar con máquinas
- Para usar con muelle de seguridad
- Perfil Dynamic-Drive para proteger las tuercas
- UNE 16507, DIN 3129, ISO 2725
- Caja fabricada en polietileno de alta densidad y resistente

R	Paquete	Paquete	Paquete	g	€
167-11-4	1	11	58x170x210	1.600	54,59
167-08-1, 167-10-1, 167-12-1, 167-14-1, 167-17-1, 167-19-1, 167-22-1, 167-24-1, 167-27-1					1/2"
169-03-1			169-25-1		

VASOS DE IMPACTO 1/2" HEX, SERIE LARGA



6 mm

R	Paquete	Paquete	A mm	B mm	C mm	L mm	g	€
168-10-1	1	10	17.5	24	25	78	118	11,47
168-11-1	1	11	18	24	25	78	121	11,56
168-13-1	1	13	20	24	25	78	163	11,79
168-14-1	1	14	22	37	25	78	190	12,50
168-16-1	1	16	24	37	25	78	239	12,50
168-17-1	1	17	26	37	30	78	239	12,50
168-18-1	1	18	27	37	30	78	239	12,50
168-19-1	1	19	28	39	30	78	246	12,50
168-21-1	1	21	30	39	30	78	267	12,79
168-22-1	1	22	32	39	30	78	328	17,97
168-23-1	1	23	34	39	30	78	348	18,02
168-24-1	1	24	34	39	30	78	351	18,07
168-27-1	1	27	38	39	30	78	373	18,40
168-30-1	1	30	42	39	30	78	409	19,92
168-32-1	1	32	43	40	32	78	415	22,15

JUEGO VASOS DE IMPACTO 1/2", SERIE LARGA, 7 piezas



1/2" mm

- Aleación de acero de cromo molibdeno de alto rendimiento
- Acabado fosfatado
- Para usar con máquinas
- Para usar con muelle de seguridad
- Perfil Dynamic-Drive para proteger las tuercas
- UNE 16507, DIN 3129, ISO 2725
- Caja fabricada en polietileno de alta densidad y resistente

R	Paquete	Paquete	Paquete	g	€
168-7-4	1	7	52x180x255	2.100	53,46
168-10-1, 168-13-1, 168-17-1, 168-19-1, 168-22-1, 168-24-1, 168-27-1					1/2"

JUEGO VASOS DE IMPACTO 1/2", SERIE LARGA, 14 piezas



1/2" mm

- Aleación de acero de cromo molibdeno de alto rendimiento
- Acabado fosfatado
- Para usar con máquinas
- Para usar con muelle de seguridad
- Perfil Dynamic-Drive para proteger las tuercas
- UNE 16507, DIN 3129, ISO 2725
- Caja fabricada en polietileno de alta densidad y resistente

R	Paquete	Paquete	Paquete	g	€
168-14-4	1	14	82x263x335	4.230	113,82
168-10-1, 168-11-1, 168-13-1, 168-14-1, 168-16-1, 168-17-1, 168-18-1, 168-19-1, 168-21-1, 168-22-1, 168-24-1, 168-27-1, 167-30-1, 167-32-1					1/2"



ACCESORIOS 1/2"

ALARGADERA

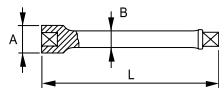

• DIN 16503, ISO 1174

🔧	📦	A mm	B mm	L mm	g	€
169-03-1	1	25	16.5	75	139	9,23
169-01-1	1	25	16.5	125	274	9,71
169-02-1	1	25	16.5	150	484	11,99

AUMENTADOR

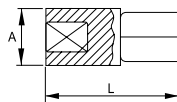

• Aumentador de 1/2" a 3/4"
• DIN 16503, ISO 1174

🔧	📦	A mm	L mm	g	€
169-60-1	1	30	48	114	13,21

REDUCTOR

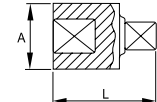

• Reductor de 1/2" a 3/8"
• DIN 16503, ISO 1174
• Dadas las condiciones especiales de este producto, no está garantizado contra la rotura del cuadrado macho

🔧	📦	A mm	L mm	g	€
169-65-1	1	25	38	129	10,96

JUNTA CARDAN

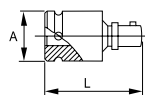

• DIN 16503, ISO 1174

🔧	📦	A mm	L mm	g	€
169-25-1	1	30	63	189	20,66

ANILLAS DE SEGURIDAD



• Anillas de seguridad 1/2"

🔧	📦	📏	📏	📏	g	€
169921	1	1/2"	10-14	5-10	2	4,95
169931	1	1/2"	15-36	12-19	2	4,95

1



2



3



4



5



6



7



8



9



10



11



12





VASOS IMPACTO 3/4"

VASOS DE IMPACTO 3/4" HEX

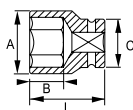

- Vasos en milímetros, diseño hexagonal
- UNE 16507, ISO 2725, DIN 3129

R	Paquete	Ø	A mm	B mm	C mm	L mm	g	€
173-17-2	1	17	30	21	44	51	339	11,38
173-18-2	1	18	32	21	44	51	339	11,69
173-19-2	1	19	33	21	44	51	349	12,01
173-21-2	1	21	35	21	44	51	359	12,19
173-22-2	1	22	36	21	44	51	359	12,36
173-23-2	1	23	37	21	44	51	369	12,78
173-24-2	1	24	38	21	44	51	379	13,24
173-27-2	1	27	41	21	44	51	399	13,68
173-28-2	1	28	42	23	44	51	409	14,34
173-29-2	1	29	45	23	44	51	409	14,80
173-30-2	1	30	46	23	44	51	439	15,34
173-32-2	1	32	48	27	44	57	469	15,68
173-33-2	1	33	50	27	44	57	489	16,48
173-34-2	1	34	51	27	44	57	509	16,79
173-36-2	1	36	53	27	44	57	519	18,13
173-38-2	1	38	56	27	44	57	559	19,58
173-41-2	1	41	59	28	44	58	659	21,60
173-46-2	1	46	66	30	44	62	709	25,47
173-50-2	1	50	71	32	54	65	839	29,04
173-55-2	1	55	77	37	54	70	1109	34,91
173-60-2	1	60	84	37	54	70	1200	38,83

VASOS DE IMPACTO 3/4" HEX, SERIE LARGA

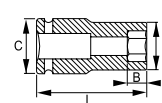

R	Paquete	Ø	A mm	B mm	C mm	L mm	g	€
174-17-2	1	17	30	23	44	90	560	19,63
174-19-2	1	19	33	23	44	90	600	20,70
174-21-2	1	21	35	23	44	90	680	21,02
174-22-2	1	22	36	23	44	90	700	21,31
174-24-2	1	24	38	23	44	90	750	22,84
174-27-2	1	27	41	23	44	90	800	23,58
174-30-2	1	30	46	27	44	90	898	27,92
174-32-2	1	32	48	27	44	90	957	28,52
174-33-2	1	33	50	27	44	90	1010	29,96
174-34-2	1	34	51	27	44	90	1030	32,30
174-36-2	1	36	55	27	44	90	1084	34,84
174-41-2	1	41	59	28	44	90	1270	41,49

ACCESORIOS 3/4"

JUNTA CARDAN

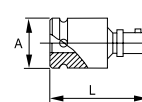

- DIN 16503, ISO 1174

R	Paquete	A mm	L mm	g	€
175-25-2	1	42	92	580	57,27

ANILLAS DE SEGURIDAD

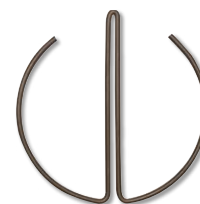

- Anillas de seguridad 3/4"

R	Paquete	Ø	Ø	Ø	g	€
175911	1	3/4"	17-46	12-24	2	5,62
179931	1	3/4"	50-60		2	6,35

JUEGO DE VASOS IMPACTO 3/4", 8 piezas



- Juego en caja metálica

R	Paquete	X	Ø	g	€
173-01-5	1	8	24 - 27 - 29 - 30 - 32 - 34 - 36 - 38 mm	4.000	125,58



ACCESORIOS 3/4"

ALARGADERAS

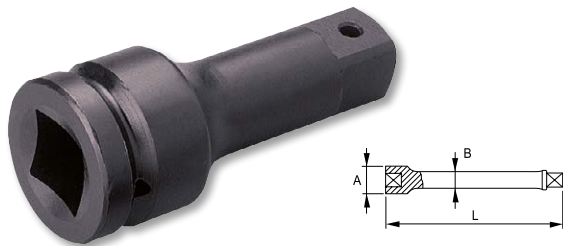

- DIN 16503, ISO 1174

€		A mm	B mm	L mm	g	€
175-01-2	1	175	44	21	850	21,79
175-10-2	1	250	44	21	1.190	25,59
175-02-2	1	325	44	21	1.460	34,15

AUMENTADOR

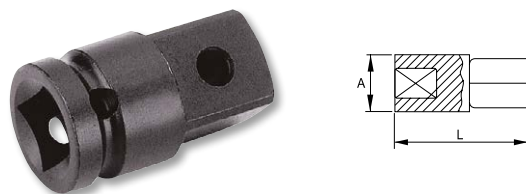

- Aumentador de 3/4" a 1"
- DIN 16503, ISO 1174

€		A mm	L mm	g	€
175-60-2	1	44	63	410	30,97

REDUCTOR



- Reductor de 3/4" a 1/2"
- DIN 16503, ISO 1174
- Dadas las condiciones especiales de este producto no está garantizado contra la rotura del cuadrado macho

€		A mm	L mm	g	€
175-65-2	1	44	57	350	18,35

VASOS IMPACTO 1"

VASOS DE IMPACTO 1" HEX

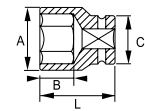

- Vasos en milímetros, diseño hexagonal
- UNE 16507, ISO 2725, DIN 3129

€			A mm	B mm	C mm	L mm	g	€
177-22-2	1	22	39	22	54	58	645	19,18
177-24-2	1	24	41	22	54	58	650	20,55
177-27-2	1	27	46	22	54	58	670	21,23
177-30-2	1	30	49	24	54	62	680	22,98
177-32-2	1	32	52	24	54	62	695	23,47
177-33-2	1	33	54	24	54	62	695	24,66
177-34-2	1	34	54	24	54	62	720	21,72
177-36-2	1	36	56	29	54	65	800	26,00
177-38-2	1	38	58	29	54	65	845	28,10
177-41-2	1	41	61	34	54	70	920	32,55
177-42-2	1	42	64	34	54	70	950	32,87
177-46-2	1	46	68	36	54	75	1150	34,77
177-50-2	1	50	73	36	54	75	1375	44,25
177-55-2	1	55	79	44	54	83	1540	50,52
177-60-2	1	60	86	47	54	87	1700	60,13
177-65-2	1	65	92	47	54	90	1940	67,63
177-70-2	1	70	97	47	54	93	2450	73,94
177-75-2	1	75	104	47	86	95	2900	81,53
177-80-2	1	80	110	39	86	100	3300	96,08

JUEGO DE VASOS IMPACTO 1", 7 piezas



- Juego en caja metálica

€								g	€
177-10-5	1	7	24 - 27 - 30 - 32 - 33 - 36 - 38 mm					5.500	161,63

1



2



3



4



5



6



7



8



9



10



11



12





VASOS IMPACTO 1"

VASOS DE IMPACTO 1" HEX, SERIE LARGA

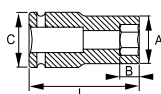

Part No.	Box	Hex Size	A mm	B mm	C mm	L mm	g	€
178-22-2	1	22	39	23	54	90	975	24,92
178-24-2	1	24	42	23	54	90	1016	26,70
178-27-2	1	27	46	23	54	90	1134	27,58
178-30-2	1	30	49	24	54	90	1256	28,29
178-32-2	1	32	52	24	54	90	1297	28,89
178-33-2	1	33	54	24	54	92	1311	31,66
178-34-2	1	34	54	24	54	92	1350	27,87
178-36-2	1	36	56	29	54	92	1474	31,31
178-38-2	1	38	58	29	54	92	1479	33,82
178-41-2	1	41	61	34	54	92	1533	42,10
178-46-2	1	46	68	36	54	95	1710	33,64
178-50-2	1	50	73	36	54	95	1896	42,90
178-55-2	1	55	79	44	54	100	2155	54,16
178-60-2	1	60	86	47	54	100	2372	62,62

ACCESORIOS 1"

ALARGADERAS

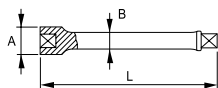

- DIN 16503, ISO 1174

Part No.	Box	A mm	B mm	L mm	g	€
179-00-2	1	125	54	34	1.085	81,35
179-01-2	1	175	54	34	1.390	87,61
179-02-2	1	325	54	34	2.395	102,13

ANILLAS DE SEGURIDAD

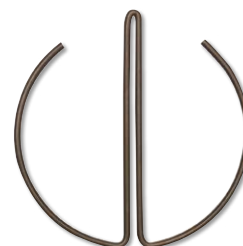

- Anillas de seguridad 1"

Part No.	Box	Size	Inner Dia	Outer Dia	g	€
179931	1	1"	19-70	17-27	9	6,35
179941	1	1"	75-80		13	8,37

REDUCTOR

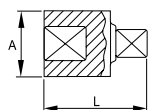

- Reductor de 1" a 3/4"
- DIN 16503, ISO 1174
- Dadas las condiciones especiales de este producto, no está garantizado contra la rotura del cuadrado macho

Part No.	Box	A mm	L mm	g	€
179-65-2	1	54	70	350	19,16

JUNTA CARDAN

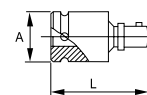

- DIN 16503, ISO 1174

Part No.	Box	A mm	L mm	g	€
179-52-2	1	54	120	650	193,55



05. TORNILLOS DE BANCO



TORNILLOS DE BANCO

GUÍA REDONDA

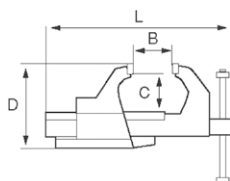
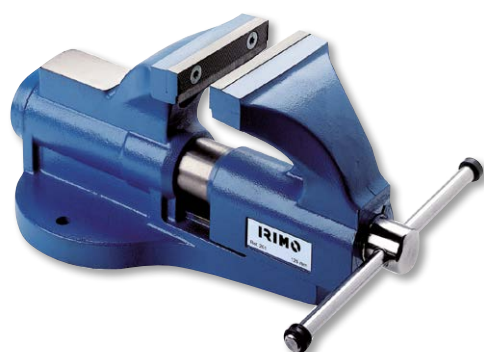

- Tornillo de banco guía redonda
- Fabricado en acero de alta calidad
- Altamente resistente
- Mordazas intercambiables
- Zona de golpeo de mayor superficie
- Husillo con rosca y palanca de giro con suave desplazamiento
- Puede ser utilizado con base giratoria

R	Icono	B mm	C mm	D mm	L mm	g	€
201231	1	80	90	42	130	260	5.850 224,47
201241	1	100	110	56	166	325	11.350 299,26
201251	1	125	130	72	196	375	18.200 412,19
201261	1	150	170	80	230	430	29.700 585,85

GUÍA CUADRADA, AJUSTE REGULABLE



- Tornillo de banco guía cuadrada
- Fabricado en acero de alta calidad
- Mordazas para tubos
- Mordazas intercambiables
- Zona de golpeo de mayor superficie
- Husillo laminado con rosca y palanca con giro y desplazamiento suave
- Compatible con base giratoria
- Ajuste de guía regulable
- Apoyo de la guía en 4 superficies mecanizadas

R	Icono	B mm	C mm	D mm	L mm	g	€
216041	1	100	145	50	122	325	6.497 273,71
216051	1	125	170	63	152	402	13.733 367,80
216061	1	150	230	80	182	492	20.388 464,75
216071	1	175	250	94	211	551	30.688 604,44

GUÍA CUADRADA

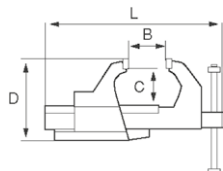

- Tornillo de banco guía cuadrada
- Fabricado en acero de alta calidad
- Alojamiento para mordazas para tubos
- Mordazas intercambiables
- Zona de golpeo de mayor superficie
- Husillo con rosca y palanca con giro suave
- Compatible con base giratoria

R	Icono	B mm	C mm	D mm	L mm	g	€
207041	1	100	145	50	122	325	6.200 232,92
207051	1	125	170	63	152	402	13.200 326,08
207061	1	150	230	80	182	492	19.800 419,25
207071	1	175	250	94	211	551	30.100 558,99



GUÍA CUADRADA

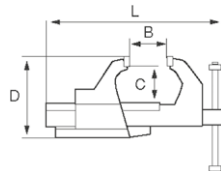

- Tornillo banco guía cuadrada
- Fundición dúctil para mayor resistencia a impactos, con características similares al acero
- Fijado con la base giratoria
- Yunque cuadrado largo
- Pin sujeción al husillo para evitar la caída de la mordaza
- Mordazas y husillos disponibles
- Certificación GS

R	Icono	Icono	B mm	C mm	D mm	L mm	g	€
207-100	1	100	100	61	164	330	11.450	150,92
207-125	1	125	125	72	193	408	20.000	226,38
207-150	1	150	150	84	223	466	29.700	295,55

REPUESTOS PARA TORNILLOS DE BANCO

MORDAZAS DE REPUESTO

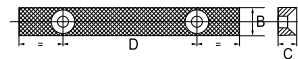

- Pareja de mordazas y tornillos para tornillo guía redonda 201

R	Icono	Icono	B mm	C mm	D mm	g	€
202401	1	80	15	10	55	170	23,07
202411	1	100	20	12	64	350	23,63
202421	1	125	20	12	77	450	34,94
202431	1	150	25	14	90	750	34,94

MORDAZAS DE REPUESTO

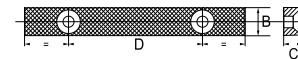

- Pareja de mordazas y tornillos para tornillo guía cuadrada 207041 / 207071 y 216

R	Icono	Icono	B mm	C mm	D mm	g	€
202441	1	100	15	10	64	350	23,63
202421	1	125	20	12	77	450	34,94
202451	1	150	20	12	90	750	42,77
202461	1	175	25	14	105	1.020	50,95

MORDAZAS DE REPUESTO

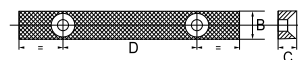

- Pareja de mordazas con tornillos para tornillo guía cuadrada 207-100 / 207-150

R	Icono	Icono	B mm	C mm	D mm	g	€
202-100	1	100	20	10	60	270	19,42
202-125	1	125	21	12	75	460	23,99
202-150	1	150	21	12	90	550	27,51

MORDAZAS PARA TUBO



- Pareja de mordazas de tubo y tornillos para tornillo guía cuadrada 207041 / 207071 y 216

R	Icono	Icono	Icono	Icono	Icono	g	€
206721	1	100	13.5 - 26.9			245	31,53
206741	1	125	21.3 - 76.1			436	39,16
206761	1	150 / 175	26.9 - 89.0			478	39,16

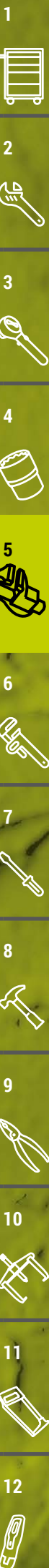



REPUESTOS PARA TORNILLOS DE BANCO

HUSILLO Y TUERCA



- Husillo y tornillo para guía redonda 201

R					€
202811	1	80	251	875	45,25
202821	1	100	317	1.400	73,38
202831	1	125	364	2.200	53,83
202841	1	150	428	3.400	124,81

HUSILLO Y TUERCA



- Husillo y tuerca para tornillo guía cuadrada 207041 / 207071 y 216

R					€
206821	1	100	287	600	41,46
206831	1	125	352	1.400	59,00
206841	1	150	432	2.200	105,47
206851	1	175	471	3.200	135,68

HUSILLO Y TUERCA



- Husillo y tuerca para tornillo guía cuadrada 207-100 / 207-150

R					€
206-100	1	100	165	560	21,46
206-125	1	125	188	920	25,98
206-150	1	150	216	1.060	28,98

ACCESORIOS PARA TORNILLOS DE BANCO

SET DE MORDAZAS DE PROTECCIÓN PARA TORNILLOS DE BANCO

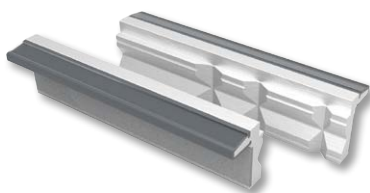

- Mordazas prismáticas de aluminio endurecido
- Ofrece una eficiente sujeción y protección de la pieza al mismo tiempo
- Diseñado para sujeción horizontal de objetos planos y redondos
- Diseñado para sujeción vertical de objetos redondos
- Ángulo de 90° en la parte superior para sujetar
- Ranura en V horizontal con un ángulo de 120° para la sujeción de tuberías y otras piezas redondas
- 3 ranuras en V verticales con ángulos de 100°, 120° y 130° para sujeción de tuberías y otras piezas redondas
- Tira magnética de neodimio extremadamente potente

R				€
202561	1	100	180	34,32
202571	1	125	200	35,64
202581	1	150	220	37,11

SET DE MORDAZAS DE PROTECCIÓN PARA TORNILLOS DE BANCO



- Mordazas neutras de aluminio endurecido
- Para la sujeción de acabados rugosos o medios, piezas mecanizadas
- Policarbonato (PC) extruido resistente a los impactos
- El aluminio endurecido ofrece una resistencia superior a la corrosión junto con un excelente acabado de la superficie
- Tira magnética de neodimio extremadamente potente

R				€
202511	1	100	180	34,06
202521	1	125	200	35,50
202541	1	150	220	36,79



SET DE MORDAZAS DE PROTECCIÓN PARA TORNILLOS DE BANCO

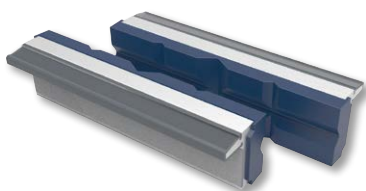

- Mordazas de poliuretano con ranuras
- Para sujeción de piezas redondas con detalles muy delicados
- Las mordazas están fabricadas con un material especial de poliuretano flexible
- Dureza Shore A82
- El poliuretano es conocido por sus habilidades únicas para "morder" la pieza de trabajo sin dañarla o rayarla
- El poliuretano es tan flexible que vuelve a su forma original después de la deformación
- Tira magnética de neodimio extremadamente potente

€			g	€
202661	1	100	150	40,34
202671	1	125	175	42,14
202681	1	150	200	43,27

SET DE MORDAZAS DE PROTECCIÓN PARA TORNILLOS DE BANCO

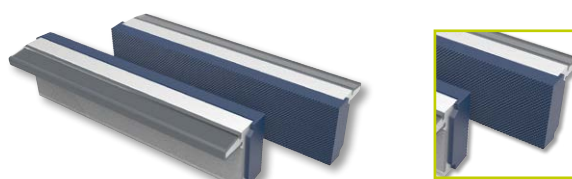

- Mordazas de poliuretano con pequeñas estrías cruzadas
- Para sujeción de piezas planas con detalles muy delicados
- Las mordazas están fabricadas con un material especial de poliuretano flexible
- Dureza Shore A82
- El poliuretano es conocido por sus habilidades únicas para "morder" la pieza de trabajo sin dañarla o rayarla
- El poliuretano es tan flexible que vuelve a su forma original después de la deformación
- Tira magnética de neodimio extremadamente potente

€			g	€
202761	1	100	150	39,19
202771	1	125	175	40,34
202781	1	150	200	41,95

BASE GIRATORIA TORNILLO DE BANCO



- Base giratoria para todos los modelos de guía redonda 201 y cuadrada 207041 / 207071 y 216

€		Ø mm	mm	L mm	d mm	g	€
201431	1	80	100	90	11	850	58,58
201451	1	100	125	115	13	1.150	89,39
201461	1	125	150	145	13	1.500	103,29
201471	1	150	175	165	17	2.500	134,09

TORNILLO DE SOBREMESA

TORNILLO DE BANCO DE SOBREMESA

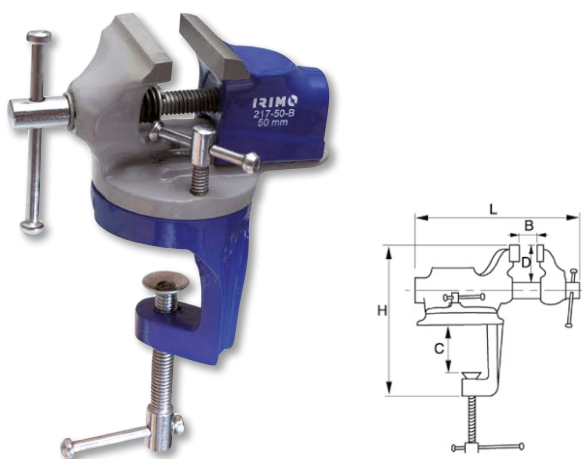

- Herramienta versatil
- Base giratoria
- Yunque acabado
- Material: hierro fundido
- En blister

€			B mm	C mm	D mm	H mm	L mm	g	€
217-50-B	1	50	40	34	20	120	125	1.100	37,35





APRIETOS DE ÉMBOLO

APRIETO MANGO DE MADERA



- Aprieto profesional con soporte fijo y corredizo y barra de acero galvanizada
- Mango de madera roscado para un ajuste cómodo
- Bocas forjadas que permiten una gran fuerza de forma constante

R		A mm	B mm	HxS mm	g	€
258-100-2	1	60	100	15.5x7.5	450	12,45
258-120-2	1	60	120	15.5x7.5	750	13,04
258-160-2	1	80	160	15.5x7.5	900	16,06
258-200-2	10	120	200	22x10.6	1.200	27,92
258-250-2	10	120	250	22x10.6	1.500	28,75
258-300-2	10	120	300	22x10.6	1.586	29,65

APRIETO DE 90 MM



R		A mm	B mm	HxS mm	g	€
256001	5	150	90	30x8	1.100	19,74
256011	5	200	90	30x8	1.200	21,21
256031	5	300	90	30x8	1.400	23,88
256041	5	400	90	30x8	1.600	26,27

APRIETO DE 120 MM

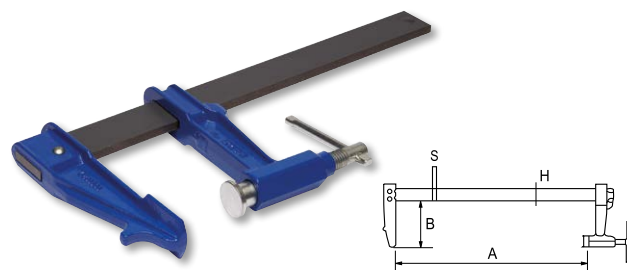

R		A mm	B mm	HxS mm	g	€
256131	5	300	120	35x8	2.000	25,70
256141	5	400	120	35x8	2.200	27,84
256151	5	500	120	35x8	2.400	30,35
256161	5	600	120	35x8	2.600	32,35
256181	5	800	120	35x8	3.000	37,13
256201	5	1.000	120	35x8	3.400	42,18

APRIETO DE 150 MM

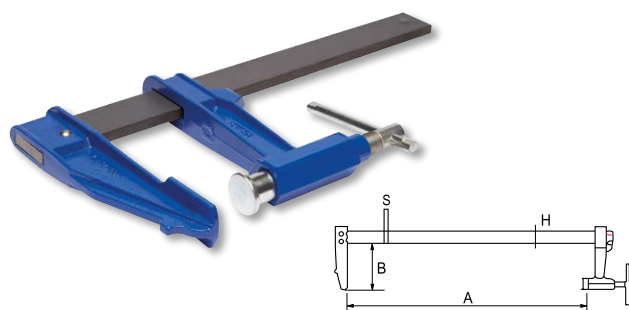

R		A mm	B mm	HxS mm	g	€
256231	5	300	150	40x10	3.100	46,01
256241	5	400	150	40x10	3.400	49,06
256251	2	500	150	40x10	3.700	51,88
256261	2	600	150	40x10	4.000	54,28
256281	2	800	150	40x10	4.600	59,52
256301	2	1.000	150	40x10	5.200	64,07
256321	1	1.200	150	40x10	5.800	67,99

TORNIQUETE DE MARQUETERÍA DE 70 MM

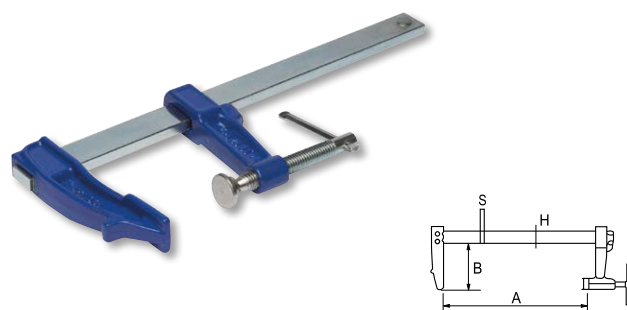

R		A mm	B mm	HxS mm	g	€
255011	10	120	70	18x7	420	11,92
255021	10	150	70	18x7	450	12,63
255031	10	200	70	18x7	500	13,61
255041	10	250	70	18x7	550	14,52
255051	10	300	70	18x7	600	15,78



APRIETO EXTRA FUERTE CON MECANISMO DE CARRACA

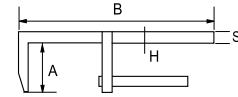

- Aprieto profesional
- Sujeción extra fuerte: 510 kg
- Cuerpo de aluminio
- Hasta 5100 Nw
- Mecanismo de carraca

Q		B mm	A mm	HxS mm	g	€
257-200-2	10	200	140	25x12	986	61,66
257-300-2	10	300	140	25x12	1.586	65,21
257-400-2	10	400	140	25x12	2.286	68,02
257-500-2	10	500	140	25x12	2.886	72,21
257-600-2	10	600	140	25x12	3.286	75,64

MORDAZAS DE AJUSTE RÁPIDO

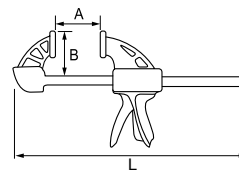

- Mordazas de alta resistencia con sistema de ajuste rápido
- Capacidad de sujeción: más de 60 kg
- Mordaza reversible



Q		A mm	B mm	L mm	g	€
254-150-2	1	150 - 6"	60	335	487	8,06
254-300-2	6	300 - 12"	60	485	586	9,02
254-450-2	6	450 - 18"	60	635	686	10,76
254-600-2	6	600 - 24"	60	785	781	12,08
254-900-2	6	900 - 36"	60	1.085	980	15,62
254-1200-2	4	1.200 - 48"	60	1.685	1.165	15,67





06. HERRAMIENTAS PARA TUBO



LLAVES STILLSON

LLAVE STILLSON

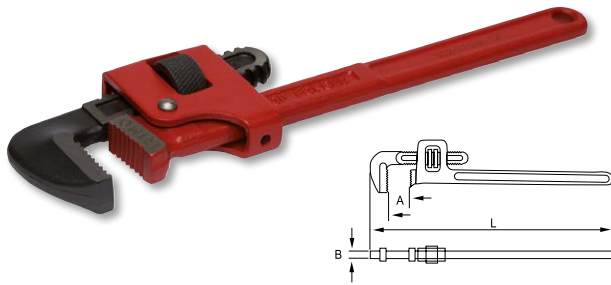

- Acero forjado
- Dentado de bocas templado a 55÷60 HRC
- Pintura epoxy de alta calidad

R	📦	A inch	A mm	B mm	L inch	L mm	g	€
302-210-2	3	1"	19	11	8"	210	290	12,16
302-260-2	3	1.3/8"	25	15	10"	260	620	13,48
302-310-2	3	1.3/4"	26	17	12"	310	800	16,30
302-365-2	3	2"	28	19	14"	365	1.120	18,29
302-465-2	1	2.3/8"	30	23	18"	465	1.890	25,93
302-615-2	1	3"	39	26	24"	615	3.200	39,42
302-900-2	1	4"	48	30	36"	900	6.100	87,13

LLAVE STILLSON DE ALUMINIO

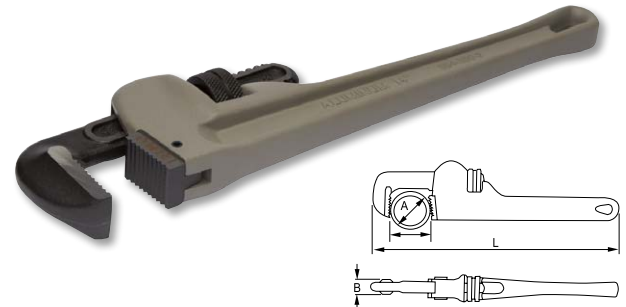

- Cuerpo de aleación de aluminio de alta resistencia con sección en doble T
- Ligera 40% menos de peso y alta resistencia

R	📦	A inch	A mm	B mm	L inch	L mm	g	€
304-250-2	2	1.1/2"	22	17	10"	250	430	20,21
304-350-2	2	2"	26	21	14"	350	950	30,23
304-450-2	1	2.1/2"	29	26	18"	450	1.650	47,45
304-600-2	1	3"	33	28	24"	600	2.500	71,59
304-900-2	1	5"	44	32	36"	900	5.200	142,10

REPUESTOS PARA LLAVE STILLSON



R	€	R	€	📦	L inch
302S-210-2	11,82	302T-210-2	5,35	1	8"
302S-260-2	13,74	302T-260-2	5,70	1	10"
302S-310-2	15,34	302T-310-2	6,39	1	12"
302S-365-2	17,43	302T-365-2	7,06	1	14"
302S-465-2	24,51	302T-465-2	9,34	1	18"
302S-615-2	38,12	302T-615-2	13,19	1	24"
302S-900-2	62,16	302T-900-2	23,27	1	36"

REPUESTOS PARA LLAVE STILLSON DE ALUMINIO



R	€	R	€	R	€	📦	L inch
304S-250-2	14,64	304T-250-2	6,29	304F-250-2	11,04	1	10"
304S-350-2	20,14	304T-350-2	7,65	304F-350-2	13,44	1	14"
304S-450-2	30,07	304T-450-2	10,29	304F-450-2	16,23	1	18"
304S-600-2	45,13	304T-600-2	14,33	304F-600-2	18,39	1	24"
304S-900-2	84,24	304T-900-2	25,37	304F-900-2	23,69	1	36"



LLAVE DE CADENA

LLAVE DE CADENA



- Cadena de acero especial templado de gran resistencia
- Función de bloqueo automático en ambas direcciones
- Funciona como una carraca en ambos sentidos

E		S	A mm	B mm	L mm	g	€
307-350-2	1	1.1/2"	8	38	350	1.400	94,96
307-685-2	1	2.1/2"	9	79	685	3.500	158,81
307-940-2	1	4"	13	60	940	6.700	180,46
307-1122-2	1	6"	20	75	1.122	12.600	388,67

CADENA DE REPUESTO



- Material: acero especial templado

E				€
307S-350-2	1	307-350-2	340	29,60
307S-685-2	1	307-685-2	475	43,98
307S-940-2	1	307-940-2	560	69,50
307S-1122-2	1	307-1122-2	830	170,87

LLAVES DE TUBO MODELO SUECO

BOCA INCLINADA

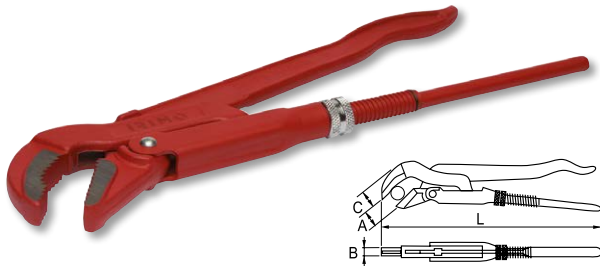

- Acero forjado
- Pintura epoxy
- Dientes templados

E		A inch	A mm	C mm	B mm	L mm	g	€
303081	1	1/2"	15	20	8	240	665	22,55
303111	1	1"	25	25	11	315	1.145	26,01
303121	1	1.1/2"	40	27	12	425	1.890	36,83
303131	1	2"	50	30	13	550	3.275	48,93
303171	1	3"	80	36	17	655	6.425	87,08

BOCA PERPENDICULAR

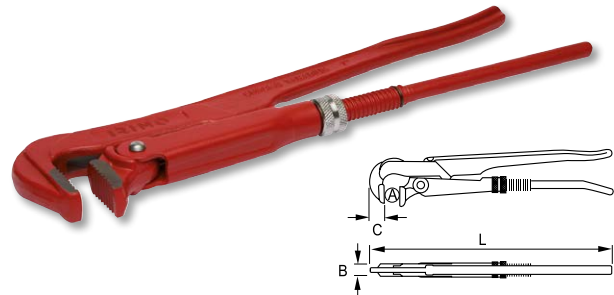

- Acero forjado
- Pintura epoxy
- Dientes templados

E		A inch	A mm	C mm	B mm	L mm	g	€
303201	1	1"	25	16	18	320	800	24,14
303211	1	1.1/2"	40	19	20	425	1.300	33,87
303221	1	2"	50	21	25	560	2.300	54,41
303231	1	3"	80	22	30	630	2.900	84,96
303241	1	4"	117	30	32	735	5.900	162,60

BOCA CURVADA

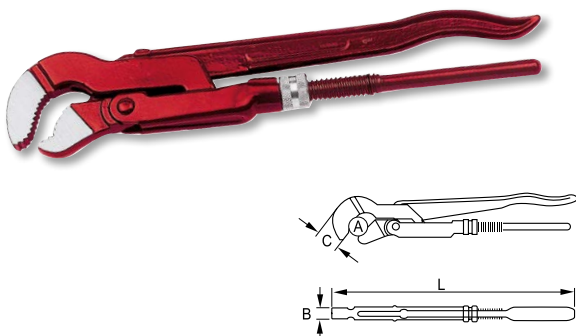

- Acero forjado
- Pintura epoxy
- Dientes templados

E		A inch	A mm	C mm	B mm	L mm	g	€
303291	1	1/2"	15	13	16	235	400	26,85
303301	1	1"	25	17	23	330	800	30,09
303311	1	1.1/2"	40	19	27	420	1.400	35,18
303321	1	2"	50	21	32	535	2.400	53,48
303331	1	3"	80	24	34	648	4.200	92,27

1



2



3



4



5



6



7



8



9



10



11



12





CORTATUBOS

MINI CORTATUBOS PARA TUBOS DE COBRE



- Esmaltado
- Fosfatado

R		S	Ø mm	L mm	g	€
321161	2	1/8" - 5/8"	3 - 16	58	122	12,19
321171	2	1/8" - 1.1/8"	3 - 30	80	220	18,54

CORTATUBOS UNIVERSAL



- Esmaltado
- Fosfatado

R		S	Ø mm	L mm	g	€
321281	1	1/8" - 1.1/8"	3 - 30	30	321	20,43

CORTATUBOS TELESCÓPICO PARA TUBOS DE COBRE



- Esmaltado
- Fosfatado

R		S	Ø mm	L mm	g	€
321361	1	1/8" - 1.3/8"	3 - 35	160	330	34,51

CORTATUBOS PARA TUBOS DE ACERO

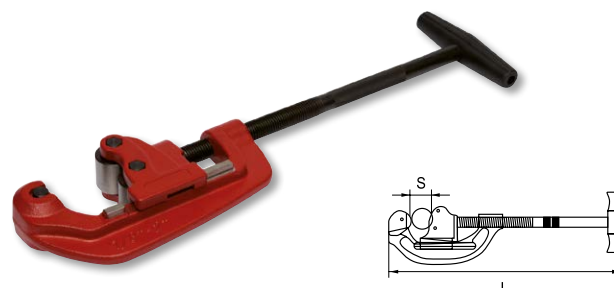

- Esmaltado
- Fosfatado

R		S	Ø mm	L mm	g	€
321501	1	1/8" - 2"	3 - 50	385	2.520	80,54

CUCHILLAS DE REPUESTO



R			D mm	d mm	E mm	g	€
321511	1	321161 / 321171 / 321281 / 321321 / 321351 / 321361	20	5	5	5	4,96
321551	1	321501	31	9	19	28	8,12

CORTATUBOS DE PLÁSTICO AUTO-RETRÁCTIL



- De 6 a 42 mm
- Utilizado para tubos de PVC, CPVC, POLY, PEX y PE
- Embalaje individual

R		L mm	g	€
321-42-1	12	205	680	46,48

CUCHILLA DE REPUESTO



- Cuchilla de repuesto para Cortatubos de plástico auto-retráctil
- Embalaje individual

R		g	€
321-BLADE-1	25	58	14,26



SACABOCADOS

JUEGO SACABOCADOS



332-51-4	1	11	140 x 130 x 40	680	125,11

333-003-2, 333-004-2, 333-006-2, 333-008-2, 333-010-2, 333-012-2, 333-014-2, 333-016-2, 333-018-2, 333-020-2	
332S-030-2	

JUEGO SACABOCADOS



332-52-4	1	16	140 x 130 x 40	680	207,18

333-003-2, 333-004-2, 333-006-2, 333-008-2, 333-010-2, 333-012-2, 333-014-2, 333-016-2, 333-018-2, 333-020-2, 333-022-2, 333-024-2, 333-026-2, 333-028-2, 333-030-2	
332S-030-2	

SACABOCADOS

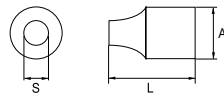

- Sacabocados intercambiables
- Para el corte de arandelas o juntas
- Cortan todos los materiales de juntas: cuero, goma, cartón, fibra, amianto, plomo, fieltro, plástico, etc.
- Triple afilado: Interno, externo y corte
- Bocas fabricadas en acero aleado y templadas en atmósfera protegida

		S mm		A mm	L mm	
333-003-2	1	3	1/2 x 24 Z"	14	31	15
333-004-2	1	4	1/2 x 24 Z"	14	31	15, 9,20
333-006-2	1	6	1/2 x 24 Z"	14	31	15
333-008-2	1	8	1/2 x 24 Z"	14	31	15, 9,20
333-010-2	1	10	1/2 x 24 Z"	14	31	15
333-012-2	1	12	Lisa	25	30	30, 13,69
333-014-2	1	14	Lisa	25	30	30
333-016-2	1	16	Lisa	25	30	30, 13,69
333-018-2	1	18	Lisa	25	30	30
333-020-2	1	20	Lisa	25	30	30, 13,69
333-022-2	1	22	Lisa	35	35	50
333-024-2	1	24	Lisa	35	35	50, 15,19
333-026-2	1	26	Lisa	35	35	50
333-028-2	1	28	Lisa	35	35	50, 15,19
333-030-2	1	30	Lisa	35	35	50

MANGO SACABOCADOS 3 - 30



332S-030-2	1	003-030 mm	350	9,20

REVÓLVER SACABOCADOS

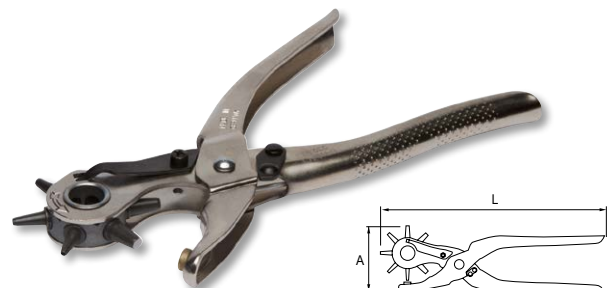

- Seis tamaños de perforación para materiales tan variados como cuero, caucho, lona, juntas y otros similares
- Fácil selección y visión del diámetro para evitar errores
- Su diseño único reduce la fuerza necesaria para el perforado en un 70%

		S	\emptyset mm	L mm		
330021	1	1/8" - 2"	3 - 50	385	2.520	27,93





A close-up photograph of a woman with grey hair, wearing a light blue shirt, focused on a task. She is holding a screwdriver with a blue and grey handle that has the word 'IRIMO' printed on it. She is using the screwdriver to work on a wooden surface, possibly a piece of furniture or a cabinet. The background is blurred, showing what appears to be a staircase or a similar structure. A bright yellow brushstroke graphic is overlaid across the middle of the image, containing the section header text.

07. DESTORNILLADORES Y PUNTAS



DESTORNILLADORES



BOCA ESTAMPADA



- Mango: bi-material con agujero para colgar
- Varilla: templada y cromada fabricada en acero de alto rendimiento
- Punta: con tratamiento anti corrosión para mayor adherencia
- Marcado: código y tamaño marcado por láser en varilla
- ISO 2380

€		$\frac{1}{2}$ mm	$\frac{3}{4}$ mm	1 mm	$\frac{1}{2}$ mm	1 mm	g	€
407-4-75	10	0.8	4	75	90	165	40	3,47
407-4-100	10	0.8	4	100	90	190	40	3,53
407-5.5-100	10	1	5.5	100	100	200	65	4,41
407-5.5-125	10	1	5.5	125	100	225	70	4,55
407-6.5-125	10	1.2	6.5	125	110	235	100	5,68
407-6.5-150	10	1.2	6.5	150	110	260	105	6,38
407-8-150	10	1.6	8	150	110	260	119	7,17
407-8-175	10	1.6	8	175	110	285	127	7,34
407-10-200	10	1.6	10	200	120	320	175	9,43
407-12-250	5	2	12	250	120	370	230	12,23
407-14-250	5	2.5	14	250	120	370	260	15,19

BOCA FRESADA



- Mango: bi-material con agujero para colgar
- Varilla: templada y cromada fabricada en acero de alto rendimiento
- Punta: con tratamiento anti corrosión para mayor adherencia
- Marcado: código y tamaño marcado por láser en varilla
- ISO 2380

€		$\frac{1}{2}$ mm	$\frac{3}{4}$ mm	1 mm	$\frac{1}{2}$ mm	1 mm	g	€
408-2.5-75	10	0.4	2.5	75	90	165	34	2,54
408-3-75	10	0.5	3	75	90	165	35	2,84
408-3-100	10	0.5	3	100	90	190	40	3,05
408-3-200	5	0.5	3	200	90	290	45	4,41
408-3.5-100	10	0.6	3.5	100	90	190	40	3,15
408-4-100	10	0.8	4	100	90	190	45	3,62
408-4-125	10	0.8	4	125	90	215	45	3,66
408-4-250	5	0.8	4	250	90	340	60	5,55
408-5.5-125	10	1	5.5	125	100	225	65	4,55
408-5.5-150	10	1	5.5	150	100	250	90	5,12
408-5.5-300	5	1	5	300	100	400	106	6,56
408-6.5-150	10	1.2	6.5	150	110	260	110	6,16

EXTRACORTO BOCA FRESADA, RECTA

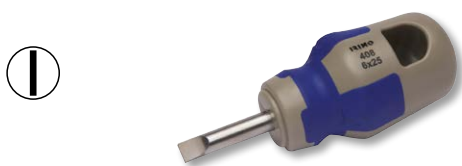

- Mango: bi-componente con agujero para colgar
- Varilla: templada y cromada fabricada en acero de alto rendimiento
- Punta: con tratamiento anti corrosión para mayor adherencia
- ISO 2380

€		$\frac{1}{2}$ mm	$\frac{3}{4}$ mm	1 mm	$\frac{1}{2}$ mm	1 mm	g	€
408-5.5-25	10	1.2	5.0	25	60	85	35	5,99
408-6.5-25	10	1.2	6.0	25	60	85	35	6,32



PHILLIPS



- Mango: bi-material con agujero para colgar
- Varilla: templada y cromada fabricada en acero de alto rendimiento
- Punta: con tratamiento anti corrosión para mayor adherencia
- Marcado: código y tamaño marcado por láser en varilla
- ISO 8764

R	Paquete	Icono	Tamaño	Largo de punta (mm)	Largo de mango (mm)	Peso (g)	€
409-0-75	10	PH-0	75	90	165	35	3,47
409-1-100	10	PH-1	100	100	200	65	4,24
409-2-125	10	PH-2	125	110	235	100	5,28
409-3-150	5	PH-3	150	120	270	160	8,17
409-4-200	5	PH-4	200	120	320	200	11,36
409-1-250	5	PH-1	250	100	350	89	6,38
409-2-300	5	PH-2	300	110	410	130	7,91

POZIDRIV



- Mango: bi-material con agujero para colgar
- Varilla: templada y cromada fabricada en acero de alto rendimiento
- Punta: con tratamiento anti corrosión para mayor adherencia
- Marcado: código y tamaño marcado por láser en varilla
- ISO 8764

R	Paquete	Icono	Tamaño	Largo de punta (mm)	Largo de mango (mm)	Peso (g)	€
413-0-75	5	PZ-0	75	90	165	35	4,10
413-1-100	5	PZ-1	100	100	200	75	4,72
413-2-125	5	PZ-2	125	110	235	100	5,73
413-3-150	5	PZ-3	150	120	270	160	8,52
413-4-200	5	PZ-4	200	120	270	205	10,81

PHILLIPS EXTRA CORTO



- Mango: bi-componente con agujero para colgar
- Varilla: templada y cromada fabricada en acero de alto rendimiento
- Punta: con tratamiento anti corrosión para mayor adherencia
- ISO 8764

R	Paquete	Icono	Tamaño	Largo de punta (mm)	Largo de mango (mm)	Peso (g)	€
409-1-25	10	PH-1	25	60	85	35	6,21
409-2-25	10	PH-2	25	60	85	35	6,43

POZIDRIV EXTRA CORTO



- Mango: bi-componente con agujero para colgar
- Varilla: templada y cromada fabricada en acero de alto rendimiento
- Punta: con tratamiento anti corrosión para mayor adherencia
- ISO 8764

R	Paquete	Icono	Tamaño	Largo de punta (mm)	Largo de mango (mm)	Peso (g)	€
413-1-25	10	PZ-1	25	60	85	35	5,26
413-2-25	10	PZ-2	25	60	85	35	5,26

1



2



3



4



5



6



7



8



9



10



11



12





DESTORNILLADORES

TORX®



- Mango: bi-material con agujero para colgar
- Varilla: templada y cromada fabricada en acero de alto rendimiento
- Punta: Negra de elevada precisión
- Marcado: código y tamaño marcado por láser en varilla

Artículo	Paquete	Tamaño	Long. punta (mm)	Long. varilla (mm)	Long. mango (mm)	Peso (g)	Peso (€)	
414-5-75	10	T-5	2.5	75	90	165	32	4,91
414-6-75	10	T-6	3	75	90	165	35	3,73
414-7-75	10	T-7	3	75	90	165	35	3,73
414-8-75	10	T-8	3	75	90	165	35	3,73
414-9-75	10	T-9	3	75	90	165	35	3,73
414-10-75	10	T-10	3	75	90	165	35	4,51
414-15-100	10	T-15	3.5	100	90	190	45	4,72
414-20-100	10	T-20	4	100	90	190	45	4,76
414-25-125	10	T-25	5	125	100	225	70	5,59
414-27-125	10	T-27	5.5	125	100	225	70	5,55
414-30-150	10	T-30	6	150	110	260	105	6,68
414-40-150	5	T-40	7	150	110	260	120	8,13
414-45-150	5	T-45	7	150	110	260	120	8,54

DESTORNILLADOR STECKER



- Mango: bi-material con agujero para colgar
- Varilla: templada 100% y cromada fabricada en acero de alto rendimiento
- Punta: con tratamiento anti corrosión para mayor adherencia
- Marcado: código y tamaño marcado por láser en varilla
- ISO 691

Artículo	Paquete	Tamaño	Long. punta (mm)	Long. varilla (mm)	Long. mango (mm)	Peso (g)	Peso (€)	
417-3.2-125	5	3.2	5.7	125	90	215	60	9,88
417-4-125	5	4	6.9	125	90	215	60	9,09
417-4.5-125	5	4.5	7.5	125	90	215	60	9,09
417-5-125	5	5	8.2	125	100	250	70	9,43
417-5.5-125	5	5.5	8.8	125	100	250	70	9,43
417-6-125	5	6	9.4	125	100	250	70	9,43
417-7-125	5	7	11.0	125	110	260	120	10,57
417-8-125	5	8	12.2	125	110	260	120	10,83
417-9-125	5	9	13.5	125	110	260	120	11,45
417-10-125	5	10	14.7	125	110	260	120	11,97
417-11-125	5	11	16.0	125	120	270	155	13,02
417-12-125	5	12	17.2	125	120	270	155	13,46
417-13-125	5	13	18.5	125	120	270	155	15,46
417-14-125	5	14	19.7	125	120	270	155	16,07

PORTAPUNTAS MAGNÉTICO PARA PUNTAS 1/4"



- Mango: bi-material con agujero para colgar
- Varilla: templada y cromada fabricada en acero de alto rendimiento
- Imán fuerte
- Marcado: código y tamaño marcado por láser en varilla

Artículo	Paquete	Tamaño	Long. punta (mm)	Long. varilla (mm)	Peso (g)	Peso (€)
475-1/4-125	5	1/4"	125	235	112	17,70



- Mango: bi-material con agujero para colgar
- Varilla: templada y cromada fabricada en acero de alto rendimiento
- Con muelle retención

Artículo	Paquete	Tamaño	Long. punta (mm)	Long. varilla (mm)	Peso (g)	Peso (€)
475-1/4F-160	5	1/4"	160	270	135	17,56



STECKER FLEXIBLE



• Mango: bi-material con agujero para colgar

E		mm	mm	mm	g	€
190-6-135	1	6	135	260	125	17,91
190-7-135	1	7	135	270	125	17,91
190-8-135	1	8	135	270	125	17,91
190-10-135	1	10	135	270	125	17,91

DESTORNILLADORES DE CARRACA PARA 12 PUNTAS DE 1/4"

DESTORNILLADOR DE CARRACA CON COMPARTIMENTO PARA 12 PUNTAS DE 1/4"



- Mango: bi-material
- Compartimiento de almacenamiento para intercambiar puntas con botón de liberación rápida
- Compartimento deslizable con 12 puntas diferentes: Ranurado 4, 5, 6 mm; PH 1, 2, 3; TORX® 15, 20, 25; Hex 3, 4, 5 mm
- El imán asegura las puntas al de destornillador
- Golpe de carraca suave
- Mecanismo de carraca de tres posiciones: avance, retroceso y neutral

E		mm	mm	mm	mm	g	€
475R-1/4-110	6	1/4"	110	125	235	310	18,61

DESTORNILLADOR A CARRACA MANGO CARROCERO



- Destornillador porta puntas a carraca con mango de carrocerero
- Mango: bi-componente
- Compartimiento para puntas intercambiables
- 6 puntas dobles de 1/4": Planas 5.0, 6.0 mm; PH1, PH2; T15, T20, T25, T30; Hex 2.5, 3, 4, 5 mm
- La varilla magnética asegura las puntas en el destornillador
- Carraca de trinquete suave. Mecanismo de 3 posiciones
- En blister

E		mm	mm	mm	mm	g	€
475R-1/4-30	6	1/4"	30	80	110	192	16,28





DESTORNILLADORES AISLADOS 1000 V

BOCA PLANA



- Para trabajos en baja tensión hasta 1000V
- Mango: Bi-material con agujero para colgar
- Varilla: Acero aleado de alto rendimiento, con recubrimiento aplicado directamente sobre la varilla
- Punta negra protegida con mayor precisión
- Marcado: Tamaño y código marcado por láser en varilla
- ISO 2380

R									€
408V-2.5-100	10	0.4	2.5	100	90	165	20	4,45	
408V-3-100	10	0.5	3	100	90	190	22	4,58	
408V-3.5-100	10	0.6	3.5	100	90	190	32	4,81	
408V-4-100	10	0.8	4	100	90	190	35	4,98	
408V-5.5-125	10	1	5.5	125	100	225	65	6,73	
408V-6.5-150	10	1.2	6.5	150	110	260	90	7,64	
408V-8-175	5	1.2	8	175	120	295	110	8,74	

PHILLIPS

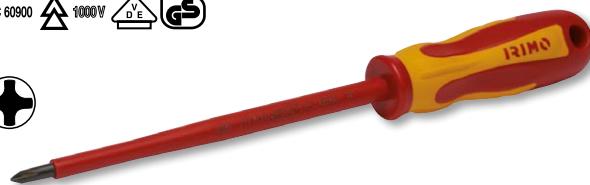

- Para trabajos en baja tensión hasta 1000V
- Mango: Bi-material con agujero para colgar
- Varilla: Acero aleado de alto rendimiento, con recubrimiento aplicado directamente sobre la varilla
- Punta negra protegida con mayor precisión
- Marcado: Tamaño y código marcado por láser en varilla
- ISO 8764

R								€
409V-0-100	10	PH-0	100	90	190	40	4,55	
409V-1-150	10	PH-1	150	100	260	80	5,68	
409V-2-175	10	PH-2	175	110	285	120	7,51	
409V-3-200	5	PH-3	200	120	320	180	9,11	

POZIDRIV



- Para trabajos en baja tensión hasta 1000V
- Mango: Bi-material con agujero para colgar
- Varilla: Acero aleado de alto rendimiento, con recubrimiento aplicado directamente sobre la varilla
- Punta negra protegida con mayor precisión
- Marcado: Tamaño y código marcado por láser en varilla
- ISO 8764

R								€
413V-0-100	10	PZ-0	100	90	190	40	5,20	
413V-1-150	10	PZ-1	150	100	260	80	6,51	
413V-2-175	10	PZ-2	175	110	285	120	7,51	
413V-3-200	5	PZ-3	200	120	320	180	9,11	

TORX®



- Para trabajos en baja tensión hasta 1000V
- Mango: Bi-material con agujero para colgar
- Varilla: Acero aleado de alto rendimiento, con recubrimiento aplicado directamente sobre la varilla
- Punta negra protegida con mayor precisión
- Marcado: Tamaño y código marcado por láser en varilla
- ISO 8764

R								€
414V-10-100	10	T-10	100	90	190	320	5,48	
414V-15-125	10	T-15	125	100	225	650	6,85	
414V-20-125	10	T-20	125	100	225	750	7,91	
414V-25-150	10	T-25	150	110	360	900	9,58	



JUEGO 2 DESTORNILLADORES AISLADOS + TESTER

IEC 60900

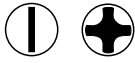

- Juego de destornilladores, 3 piezas
- Para tornillos de cabeza recta y Phillips

Artículo	Caja	Paquete	Dimensiones	Peso	Precio
459V-3-1	1	3	35x130x310	35	19,92
408V-4-100					
409V-1-150					
429-03-1					

JUEGOS DE DESTORNILLADORES

JUEGO PLANO-PHILLIPS, 6 piezas

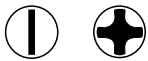

- Para tornillos planos y Phillips
- En caja de cartón

Artículo	Caja	Paquete	Dimensiones	Peso	Precio
459-6-C	1	6	42x325x160	570	27,18
408-3-75, 408-4-100					
407-5.5-125, 407-6.5-150					
409-1-100, 409-2-125					

JUEGO PLANO-POZIDRIV PARA MECÁNICO, 6 piezas



- Para tornillos planos y Pozidriv
- En caja de cartón

Artículo	Caja	Paquete	Dimensiones	Peso	Precio
459-6A-C	1	6	42x325x160	570	27,18
408-3-75, 408-4-100					
407-5.5-125, 407-6.5-150					
413-1-100, 413-2-125					

1



2



3



4



5



6



7



8



9



10



11



12





JUEGOS DE DESTORNILLADORES

JUEGO PLANO-PHILLIPS, 5 piezas

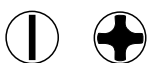

- Para tornillos planos y Phillips
- Embalaje en blíster

€	Paquete	Blister	Dimensiones (mm)	Peso (g)	€
459-5-B	1	5	48x190x335	435	22,41
408-3-75, 408-4-100					
407-6.5-150					
409-1-100, 409-2-125					

JUEGO TORX®, 6 piezas



- Para tornillos TORX®
- En caja de cartón

€	Paquete	Blister	Dimensiones (mm)	Peso (g)	€
459-6B-C	1	6	42x325x160	470	31,83
414-10-75, 414-15-100, 414-20-100, 414-25-125, 414-27-125, 414-30-150					

JUEGO PLANO-POZIDRIV PARA ELECTRICISTA, 6 piezas



- Para tornillos planos y Phillips
- En caja de cartón

€	Paquete	Blister	Dimensiones (mm)	Peso (g)	€
459-6C-C	1	6	42x325x160	505	26,07
408-3-100, 408-4-125, 408-5.5-150					
409-1-100, 409-2-125					
429-03-1					



EXPOSITORES DE DESTORNILLADORES

EXPOSITOR 83 DESTORNILLADORES

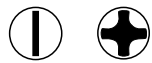

- Display de 83 destornilladores
- Para tornillos planos y Phillips

IRIMO	Paquete	Cantidad	Dimensiones	Peso	Precio
910-83DISP	1	83	500x450x250	8.500	409,28
MEE-COUNT-IR-2	expositor vacio				-
8x 408-3-75, 8x 408-4-100, 6x 408-5.5-150, 7x 408-6.5-150					
6x 407-10-200, 8x 407-4-100, 7x 407-5.5-125, 6x 407-6.5-150, 6x 407-8-175					
8x 409-0-75, 7x 409-1-100, 6x 409-2-125					

EXPOSITOR 152 DESTORNILLADORES



- Display de 152 destornilladores
- Para tornillos planos, Phillips y TORX®

IRIMO	Paquete	Cantidad	Dimensiones	Peso	Precio
910-152DISP	1	152	775x450x250	14.100	707,35
MEE-COUNT-IR-3	expositor vacio				-
8x 408-2.5-75, 8x 408-3.5-100, 8x 408-3-75, 8x 408-4-100, 7x 408-5.5-125, 6x 408-6.5-150					
6x 407-10-200, 8x 407-4-100, 7x 407-5.5-125, 6x 407-6.5-150, 6x 407-8-175					
6x 408-6.5-25					
8x 409-0-75, 7x 409-1-100, 6x 409-2-125, 6x 409-3-150					
6x 409-2-25					
8x 414-10, 7x 414-15, 7x 414-20, 7x 414-25, 6x 414-30					





JUEGOS DE DESTORNILLADORES DE SEGURIDAD

JUEGO PLANO-PHILLIPS, 6 piezas

IEC 60900 1000V



- Para tornillos planos y Phillips
- En caja de cartón

€					€
459V-6-C	1	6	42x325x160	580	40,35
408V-2.5-100, 408V-4-100, 408V-5.5-125, 408V-6.5-150					
409V-1-150, 409V-2-175					

EXPOSITORES DE DESTORNILLADORES

EXPOSITOR 72 DESTORNILLADORES DE SEGURIDAD

IEC 60900 1000V

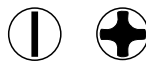

- Display de 72 destornilladores de seguridad
- Para tornillos planos y Phillips

€					€
910V-72DISP	1	72	500x450x250	9.075	421,49
MEE-COUNT-IR-2	expositor vacío				-
8x 408V-2.5-100, 8x 408V-3.5-100, 8x 408V-3-100, 8x 408V-4-100, 7x 408V-5.5-125, 6x 408V-6.5-150, 6x 408V-8-175					
8x 409V-0-100, 7x 409V-1-150, 6x 409V-2-175					

DESTORNILLADORES MANGOS EN T

HEXAGONAL

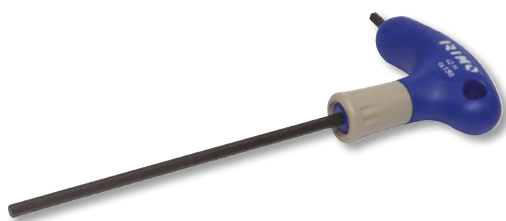

- Varilla: Acero de alta Calidad. Punta negra con mayor precisión
- La longitud de varilla permite aplicar un par controlado y mayor accesibilidad
- La varilla corta del mango a 90° se utiliza para pares muy fuertes o donde zona de trabajo tiene una altura limitada
- Marcado: Tamaño y código marcado por láser en varilla
- Arandela giratoria muy práctica y útil en la base del mango para un giro rápido en la primera fase del apriete

€							€
42-H2-100	5	2	130	100	64x30	23	6,64
42-H2.5-100	5	2.5	130	100	64x30	25	6,64
42-H3-100	5	3	130	100	64x30	28	6,71
42-H4-150	5	4	190	150	80x40	57	7,61
42-H5-150	5	5	190	150	80x40	70	7,92
42-H6-200	5	6	250	200	100x50	134	11,38
42-H8-200	5	8	250	200	100x50	186	12,47
42-H10-200	5	10	250	200	100x50	254	13,80



TORX®



- Varilla: Acero de alta Calidad. Punta negra con mayor precisión
- La longitud de varilla permite aplicar un par controlado y mayor accesibilidad
- La varilla corta del mango a 90° se utiliza para pares muy fuertes o donde zona de trabajo tiene una altura limitada
- Marcado: Tamaño y código marcado por láser en varilla
- Arandela giratoria muy práctica y útil en la base del mango para un giro rápido en la primera fase del apriete

€									€
46-T10-100	5	T10	2.72	130	100	64x30	27	8,19	
46-T15-150	5	T15	3.26	190	150	80x40	55	8,88	
46-T20-150	5	T20	3.84	190	150	80x40	55	9,15	
46-T25-150	5	T25	4.40	190	150	80x40	66	9,76	
46-T30-200	5	T30	5.49	250	200	100x50	126	10,10	
46-T40-200	5	T40	6.60	250	200	100x50	147	10,98	

LLAVE DE VASO MANGO EN T



- Varilla templada en su total longitud fabricada en acero de alta calidad
- Marcado: Tamaño y código marcado por láser en varilla
- Arandela giratoria muy práctica y útil en la base del mango para un giro rápido en la primera fase del apriete

€								€
191-6-150	5	6	190	150	69x40	78	11,06	
191-7-175	5	7	225	175	84x50	121	11,96	
191-8-175	5	8	225	175	84x50	123	12,17	
191-10-175	5	10	225	175	84x50	160	12,91	
191-12-175	5	12	225	175	84x50	167	14,31	
191-13-175	5	13	225	175	84x50	172	15,25	

HEXAGONAL BOLA

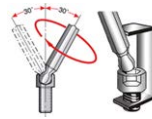

- Acero de alta calidad. Acabado en negro
- La varilla larga permite un apriete controlado y fácil acceso a los tornillos que requieren profundidad
- La varilla corta de 90° se usa para aprietes fuertes o para trabajar en espacios limitados
- La bola permite introducir la cabeza en el tornillo desde diferentes ángulos
- Más eficiente que el mango en T estándar
- Código y tamaño marcado a láser en varilla para fácil identificación

€								€
42B-H3-100	5	3	130	100	64x30	28	7,17	
42B-H4-150	5	4	190	150	80x40	57	8,13	
42B-H5-150	5	5	190	150	80x40	70	8,45	
42B-H6-200	5	6	250	200	100x50	134	12,14	
42B-H8-200	5	8	250	200	100x50	186	13,31	
42B-H10-200	5	10	250	200	100x50	254	14,75	

JUEGO DE 6 DESTORNILLADORES LLAVES ALLEN, MANGO EN T

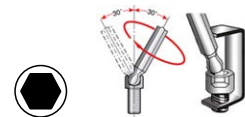

- Mango en T con bola hexagonal
- En blister

€					€
42B-6-B	1	6	355x247x40	120	63,95

42B-H10-200, 42B-H3-100, 42B-H4-150, 42B-H5-150, 42B-H6-200, 42B-H8-200

1



2



3



4



5



6



7



8



9



10



11



12





DESTORNILLADOR 6 EN 1



- Puntas dobles (6,35 x 65 mm): PH1-5 mm
- Puntas dobles (8 x 75 mm): PH2-6 mm
- Destornillador Stecker: 6, 8 mm

475-S-1	1	1/4" / 5/16"	50	110	160	312 €

DESTORNILLADOR REVERSIBLE



- Mango: plástico de alta resistencia a impactos
- Varilla niquelada

427411	10	1.2	6	PH-2	156	26 €

MAGNETIZADOR – DESMAGNETIZADOR



- Para magnetizar y desmagnetizar diferentes herramientas
- Dispositivo pequeño de fácil manejo
- Material: magnético, plástico
- En blíster

458-02-1	5	53x50x30	164	4,71 €



DESTORNILLADORES DE PRECISI3N

JUEGO DE 6 DESTORNILLADOR DE PRECISI3N



ABRIR
CERRAR

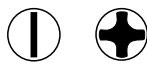

- Juego destornilladores de precisi3n, 6 piezas
- Varillas de acero cromo-vanadio
- Acabado cromado con punta negra para mayor precisi3n
- Cabeza giratoria
- Sistema de deslizamiento de la caja para abrir y cerrar
- Medidas incluidas:
 - 4 planos: 1,6-2,0-5,5-3,0 mm
 - 2 Phillips: PH00-PH0

IRIMO	Icono	mm	mm	g	€
461-6-B	1	150	50	120	11,62

DESTORNILLADOR DE PRECISI3N DE BOLSILLO



478-4-1



478-4-2



- 2 varillas cortas
- 4 puntas: PH0 / 3 mm y PH1 / 4 mm
- Acabado satinado con tratamiento en la punta
- Tamaño de boli con clip incluido para llevarlo f3cilmente
- 478-4-2: Expositor de 48 destornilladores doble boca

IRIMO	Icono	mm	mm	mm	g	€
478-4-1	1	PH0/PH1	120	3.0/4.0	20	3,99
478-4-2	48	PH0/PH1	120	3.0/4.0	1.100	3,37

BUSCAPOLOS



429-03-1
429-04-1



429-10-1

- Mango: Transparente resistente a impactos
- Varilla: niquelada y protegida hasta la punta
- Fabricado seg3n normativa DIN VDE 0680/6 GS
- 429-10-1: tester 6-24V

IRIMO	Icono	mm	mm	mm	mm	mm	g	€
429-03-1	6	0.6	3.0	65	75	140	30	3,96
429-04-1	6	-	3.5	100	90	190	29	3,90
429-10-1	6	-	3.0	45	75	120	22	4,86





LLAVES TIPO ALLEN NIQUELADAS

LLAVES TIPO ALLEN NIQUELADAS, MÉTRICA



- Niquelada
- Tamaño marcado en la varilla
- ISO 2936

€			a mm	b mm		€
040001	10	1.5	15	47	1	0,46
040011	10	2.0	18	52	1	0,47
040021	10	2.5	21	59	3	0,56
040031	10	3.0	23	66	4	0,62
040041	10	4.0	29	74	10	0,76
040051	10	5.0	33	85	18	0,87
040061	10	6.0	38	96	29	1,05
040071	10	7.0	41	102	41	1,43
040081	10	8.0	44	108	57	1,96
040091	5	9.0	47	114	76	2,17
040101	5	10.0	50	122	100	2,75
040121	5	12.0	57	137	163	4,02
040141	1	14.0	70	154	253	5,42
040171	1	17.0	80	177	427	7,65
040191	1	19.0	89	199	600	12,93
040221	1	22.0	102	222	910	19,14

LLAVES TIPO ALLEN NIQUELADAS, PULGADAS



- Niquelada
- Tamaño marcado en la varilla
- ISO 2936

€			a mm	b mm		€
040541	10	1/16"	15	47	1	0,51
040011	10	5/64"	18	52	1	0,47
040561	10	3/32"	21	59	3	0,67
040581	10	1/8"	23	66	4	0,76
040041	10	5/32"	29	74	10	0,76
040601	10	3/16"	33	85	18	1,09
040611	10	7/32"	35.5	91	29	1,32
040621	10	1/4"	38	96	32	1,62
040641	10	5/16"	44	108	60	2,02
040661	5	3/8"	50	122	100	2,83
040681	5	7/16"	53	129	140	3,45
040701	5	1/2"	63	145	182	4,21
040731	1	5/8"	76	168	370	7,08
040191	1	3/4"	89	199	601	12,93

JUEGOS LLAVES TIPO ALLEN MÉTRICA EN BOLSA



- En bolsa de plástico
- Tamaño marcado en la bolsa para fácil selección
- Agujero para colgar

€					€
041011	1	6	2.0, 2.5, 3.0, 4.0, 5.0, 6.0 mm	76	7,15
041071	1	8	2.0, 2.5, 3.0, 4.0, 5.0, 6.0, 7.0, 8.0 mm	180	11,95
041021	1	10	2.0, 2.5, 3.0, 4.0, 5.0, 6.0, 7.0, 8.0, 10, 12 mm	380	15,70
041091	1	11	2.0, 2.5, 3.0, 4.0, 5.0, 6.0, 7.0, 8.0, 9.0, 10, 12 mm	570	21,04
041031	1	13	2.0, 2.5, 3.0, 4.0, 5.0, 6.0, 7.0, 8.0, 10, 12, 14, 17, 19 mm	1.800	43,12
041101	1	15	2.0, 2.5, 3.0, 4.0, 5.0, 6.0, 7.0, 8.0, 9.0, 10, 12, 14, 17, 19, 22 mm	2.920	67,50

JUEGOS LLAVES TIPO ALLEN PULGADAS EN BOLSA



- En bolsa de plástico
- Tamaño marcado en la bolsa para fácil selección
- Agujero para colgar

€					€
041041	1	5	1/8, 5/32, 3/16, 7/32, 1/4"	95	8,78
041051	1	9	1/8, 5/32, 3/16, 7/32, 1/4, 5/16, 3/8, 7/16, 1/2"	580	21,29
041061	1	12	1/8, 5/32, 3/16, 7/32, 1/4, 5/16, 3/8, 7/16, 1/2, 9/16, 5/8, 3/4"	1.865	45,86



JUEGOS LLAVES TIPO ALLEN NIQUELADAS, EN LLAVERO



• En llavero

R	📦	📦	🔧	g	€
041111	1	6	2-2.5-3-4-5-6 mm	77	9,74
041121	1	8	2-2.5-3-4-5-6-8-10 mm	240	14,21

JUEGO 3 DESTORNILLADORES ACODADOS DOBLES, 3 piezas



- 3 piezas con doble punta (recta y PH)
 - Planas: 5.0, 6.0, 8.0 mm
 - Phillips: PH1, PH2, PH3
- Acabado cromado
- En blíster

R	📦	📦	📦	g	€
420-3-1	1	3	20x230x100	202	8,77

LLAVES TIPO ALLEN CROMADAS, LARGAS

JUEVO LLAVES TIPO ALLEN CROMADAS PARA TORNILLOS HEXAGONALES, ACABADO EN BOLA, EN MM



- Juego de 9 llaves largas con bola, en mm
- Tamaños marcados en la tapa para su fácil identificación
- Embalaje en blíster

R	📦	📦	🔧	g	€
48-9C-H	1	9	1.5-2-2.5-3-4-5-6-8-10 mm	360	15,99

LLAVES TIPO ALLEN PAVONADAS

LLAVES TIPO ALLEN PAVONADAS, MÉTRICA

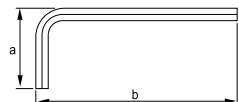

- Pavonada
- Tamaño marcado en la varilla
- ISO 2936

R	📦	🔧	a mm	b mm	g	€
045001	10	1.5	15	47	1	0,46
045011	10	2.0	18	52	2	0,46
045021	10	2.5	21	59	3	0,53
045031	10	3.0	23	66	4	0,62
045041	10	4.0	29	74	10	0,63
045051	10	5.0	33	85	13	0,91
045061	10	6.0	38	95	29	1,11
045071	10	7.0	41	102	41	1,52
045081	10	8.0	44	105	57	1,73
045091	5	9.0	47	114	76	2,34
045101	5	10.0	50	122	100	2,43
045121	5	12.0	57	137	163	3,58
045141	1	14.0	70	154	253	5,03
045171	1	17.0	80	177	427	8,07
045191	1	19.0	89	199	600	11,35
045221	1	22.0	102	222	910	18,15





LLAVES TIPO ALLEN PAVONADAS

LLAVES TIPO ALLEN PAVONADAS, MÉTRICA

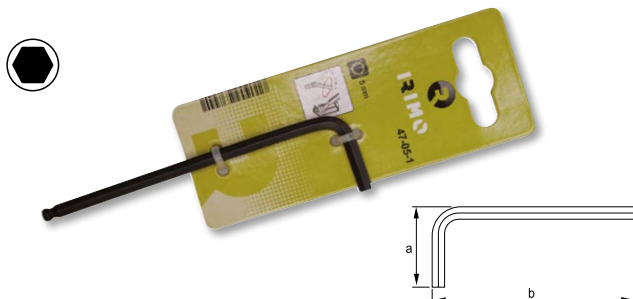

- Aleación de acero de alto rendimiento
- Pavonada
- Tamaño marcado en la varilla
- ISO 2936

R		mm	a mm	b mm	g	€
45-00-1	1	1.5	14.5	45.5	5.4	0,53
45-01-1	1	2.0	27.0	51.0	6.4	0,53
45-02-1	1	2.5	19.5	55.5	7.5	0,58
45-03-1	1	3.0	22.0	64.0	9.4	0,67
45-04-1	1	4.0	28.0	72.0	14.4	0,68
45-05-1	1	5.0	22.0	83.0	22.4	0,98
45-06-1	1	6.0	38.0	94.0	33.8	1,18
45-08-1	1	7.0	37.0	105.0	63.8	1,79
45-10-1	1	10.0	49.0	119.0	107.3	2,49

JUEGOS LLAVES TIPO ALLEN PAVONADAS, MM



- Juego de 9 llaves hex pavonadas, mm
- Tamaño marcados en el plástico para su fácil identificación
- Embalaje en blíster

R		X		g	€
46-9-H	1	9	1.5, 2, 2.5, 3, 4, 5, 6, 8, 10 mm	270	7,78

JUEGOS LLAVES TIPO ALLEN PAVONADAS, MM



- En bolsa de plástico
- Tamaño marcado en la bolsa para fácil selección
- Agujero para colgar

R		X		g	€
046011	1	6	2.0, 2.5, 3.0, 4.0, 5.0, 6.0 mm	76	6,18
046021	1	10	2.0, 2.5, 3.0, 4.0, 5.0, 6.0, 7.0, 8.0, 10, 12 mm	180	15,12
046091	1	11	2.0, 2.5, 3.0, 4.0, 5.0, 6.0, 7.0, 8.0, 9.0, 10, 12 mm	460	18,59
046031	1	13	2.0, 2.5, 3.0, 4.0, 5.0, 6.0, 7.0, 8.0, 10, 12, 17, 19 mm	1.805	39,78
046101	1	15	2.0, 2.5, 3.0, 4.0, 5.0, 6.0, 7.0, 8.0, 9.0, 10, 12, 14, 17, 19, 22 mm	2.830	62,65

JUEGOS LLAVES TIPO ALLEN PAVONADAS, MM



- Juego de 8 llaves hex pavonadas, mm
- Presentado en navaja
- Permite diversas posiciones de trabajo
- Tope a los 270°, máximo ángulo de giro
- De fácil almacenaje

R		X		g	€
46-8-F	1	8	1.5, 2.0, 2.5, 3.0, 4.0, 5.0, 6.0, 8.0 mm	160	11,18



LLAVES TIPO ALLEN PAVONADAS, PULGADAS



- Pavonadas
- Tamaño impreso en la varilla para su fácil identificación
- ISO 2936

R	📦	🔸	a mm	b mm	g	€
045541	10	1/16"	15	47	1	0,47
045011	10	5/64"	18	52	2	0,46
045561	10	3/32"	21	59	3	0,40
045581	10	1/8"	23	66	5	0,47
045041	10	5/32"	29	74	10	0,63
045601	10	3/16"	33	85	16	0,66
045611	10	7/32"	35.5	91	24	0,89
045621	10	1/4"	38	96	32	1,46
045641	10	5/16"	44	105	60	1,75
045661	5	3/8"	50	122	100	2,41
045681	5	7/16"	53	129	140	3,04
045701	5	1/2"	63	145	182	3,70
045731	1	5/8"	76	168	370	6,23
045191	1	3/4"	89	199	601	11,35

JUEGOS LLAVES TIPO ALLEN PAVONADAS, PULGADAS



- En bolsa de plástico
- Tamaño marcado en la bolsa para fácil selección
- Agujero para colgar

R	📦	📦	🔸	g	€
046041	1	5	1/8, 5/32, 3/16, 7/32, 1/4"	95	8,09
046051	1	9	1/8, 5/32, 3/16, 7/32, 1/4, 5/16, 3/8, 7/16, 1/2"	580	19,25
046061	1	12	3/32, 1/8, 5/32, 3/16, 7/32, 1/4, 5/16, 3/8, 7/16, 1/2, 5/8, 3/4"	1.865	41,19

LLAVES TIPO ALLEN PAVONADAS, LARGAS

LLAVES TIPO ALLEN PAVONADAS, LARGAS, MÉTRICA

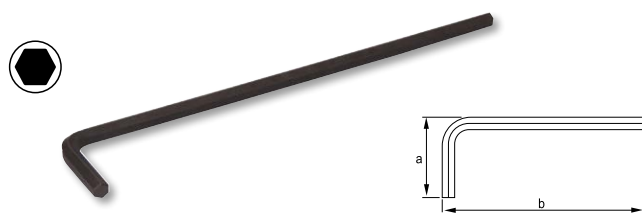

- Tamaño marcado en la varilla para fácil identificación
- La mayor longitud permite mejor accesibilidad y mayor par de transmisión
- ISO 2936

R	📦	🔸	a mm	b mm	g	€
045801	10	1.5	15	91	1	0,51
045811	10	2.0	18	102	3	0,54
045821	10	2.5	21	114	5	0,58
045831	10	3.0	23	129	8	0,72
045841	10	4.0	29	144	17	0,83
045851	10	5.0	33	165	31	1,05
045861	10	6.0	38	186	51	1,78
045871	10	7.0	41	197	64	2,63
045881	5	8.0	44	208	100	3,05
045891	5	9.0	47	219	134	3,83
045901	5	10.0	50	234	175	4,44
045921	2	12.0	57	262	283	6,48
045941	2	14.0	70	294	439	8,29

1



2



3



4



5



6



7



8



9



10



11



12





LLAVES TIPO ALLEN PAVONADAS, LARGAS

LLAVES TIPO ALLEN PAVONADAS, LARGAS, MÉTRICA CON BOLA

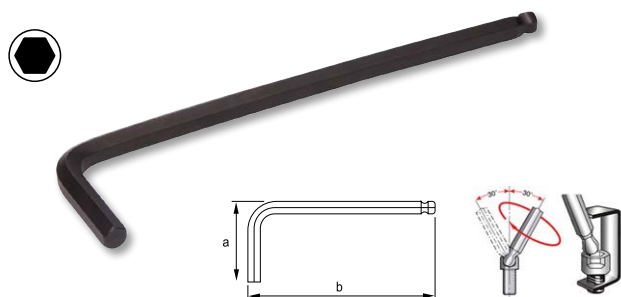

- Tamaño marcado en la varilla para fácil identificación
- La mayor longitud permite mejor accesibilidad y mayor par de transmisión
- Más eficiente dado que la bola permite introducir la cabeza en el tornillo desde diferentes ángulos
- ISO 2936

R			a mm	b mm	g	€
047001	10	1.5	15	91	1	1,23
047011	10	2.0	18	102	3	1,40
047021	10	2.5	21	114	5	1,46
047031	10	3.0	23	129	8	1,52
047041	10	4.0	29	144	17	1,82
047051	10	5.0	33	165	31	2,21
047061	10	6.0	38	186	50	3,37
047081	10	8.0	44	208	100	4,74
047101	5	10.0	50	234	171	8,51
047121	2	12.0	57	262	275	9,10

JUEGO LLAVES TIPO ALLEN LARGAS CON BOLA, MM

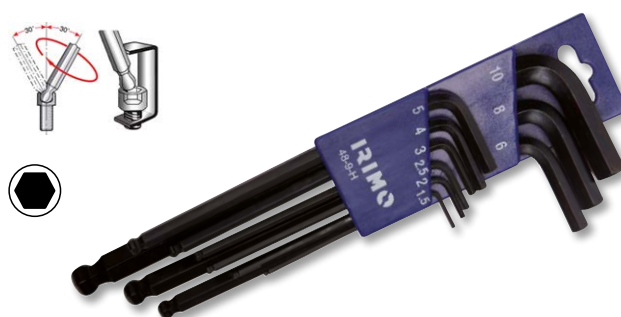

- Juego de 9 llaves tipo allen largas con bola, en mm
- Tamaños marcados en la tapa para su fácil identificación
- Embalaje en blíster

R				g	€
48-9-H	1	9	1.5, 2, 2.5, 3, 4, 5, 6, 8, 10 mm	360	15,72

LLAVES TIPO ALLEN PAVONADAS, LARGAS, MÉTRICA CON BOLA

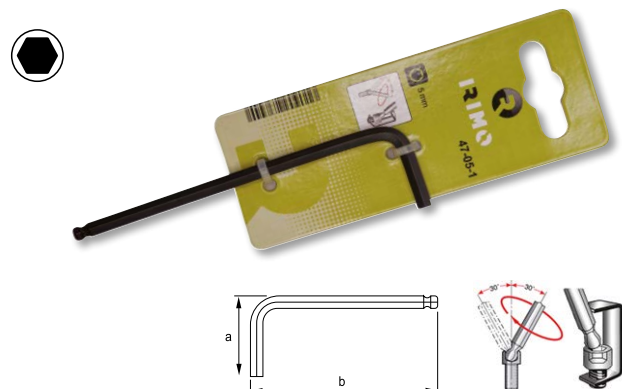

- Aleación de acero de alto rendimiento
- Pavonada
- Tamaño marcado en la varilla
- Brazo largo para fácil manejo
- Mayor eficiencia y ahorro de tiempo que con las llaves estándar
- ISO 2936

R			a mm	b mm	g	€
47-00-1	1	1.5	14.5	62.5	6.0	1,29
47-01-1	1	2.0	17.0	76.0	7.2	1,45
47-02-1	1	2.5	19.5	85.5	8.8	1,52
47-03-1	1	3.0	22.0	91.0	11.0	1,59
47-04-1	1	4.0	28.0	102.0	17.6	1,87
47-05-1	1	5.0	32.0	118.0	28.0	2,27
47-06-1	1	6.0	37.0	139.0	44.4	3,44
47-08-1	1	8.0	43.0	155.0	82.6	4,79
47-10-1	1	10.0	49.0	177.0	144.0	8,57

JUEGO LLAVES TIPO ALLEN LARGAS CON BOLA, PULGADAS



- Juego de 13 llaves tipo allen con bola largas, pulgadas
- Tamaños marcados en el plástico para su fácil identificación
- Embalaje en blíster

R				g	€
48A-13-H	1	9	0.05-1/16-5/64-3/32-7/64-1/8-9/64-5/32-3/16-7/32-1/4-5/16-3/8"	360	16,48



LLAVES TIPO ALLEN PAVONADAS TORX®

LLAVES TIPO ALLEN PAVONADAS TORX®



- Pavonadas
- Tamaño marcado en la varilla para fácil identificación
- La mayor longitud permite mejor accesibilidad y mayor par de transmisión

Q	📦	♻️	a mm	b mm	g	€
457061	5	T-6	15	75	4	3,99
457071	5	T-7	16	80	4	4,04
457081	5	T-8	16	80	5	4,11
457091	5	T-9	16	80	5	4,16
457101	5	T-10	17	86	6	4,25
457151	5	T-15	18	90	10	4,36
457201	5	T-20	19	95	11	4,54
457251	5	T-25	20	100	17	4,58
457271	5	T-27	21	105	19	4,66
457301	5	T-30	24	114	29	4,72
457401	5	T-40	26	124	43	4,94
457451	5	T-45	29	133	61	5,16
457501	5	T-50	32	152	88	5,88

JUEGO LLAVES TIPO ALLEN TORX®



- Juego de 9 llaves tipo allen TORX® acabado en negro
- Tamaño marcado en la llave para una fácil identificación
- Agujero para colgar
- Embalaje en blíster

Q	📦	📦	🔧	♻️	g	€
458-9-H	10	9	T10, T15, T20, T25, T27, T30, T40, T45, T50		290	19,65

LLAVES TIPO ALLEN PAVONADAS TORX®

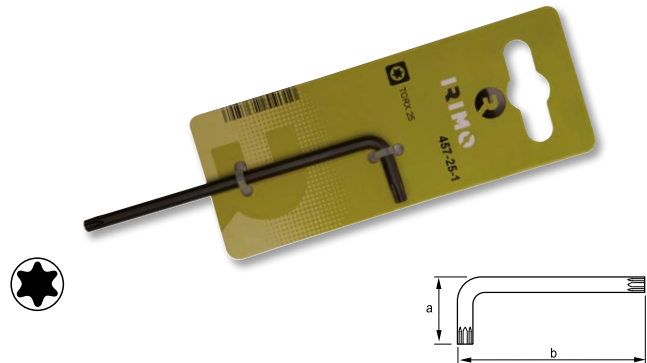

- Aleación de acero de alto rendimiento
- Pavonada
- Tamaño marcado en la varilla
- Brazo largo para fácil manejo

Q	📦	♻️	a mm	b mm	g	€
457-10-1	1	T10	17	86	10.0	4,54
457-15-1	1	T15	18	90	12.2	4,63
457-20-1	1	T20	19	95	15.2	4,81
457-25-1	1	T20	20	100	18.8	4,86
457-27-1	1	T27	21	105	23.2	4,96
457-30-1	1	T30	24	114	28.0	5,01
457-40-1	1	T40	26	124	48.2	5,23
457-45-1	1	T45	29	133	66.4	5,46
457-50-1	1	T50	32	152	94.2	6,22

JUEGO LLAVES TIPO ALLEN TORX®



- Juego en navaja de 8 llaves tipo allen TORX® acabado en negro
- Navaja bi-material resistente a impactos
- Permite trabajar en distintas posiciones
- Tope a 270°, máximo ángulo de giro
- Embalaje en blíster

Q	📦	📦	🔧	♻️	g	€
458-8-F	1	8	T9, T10, T15, T20, T25, T27, T30, T40		160	11,30

1



2



3



4



5



6



7



8



9



10



11



12





LLAVES TIPO ALLEN PAVONADAS PARA TORNILLOS TORX® INVIOABLES

LLAVES TIPO ALLEN PAVONADAS TORX® INVIOABLES

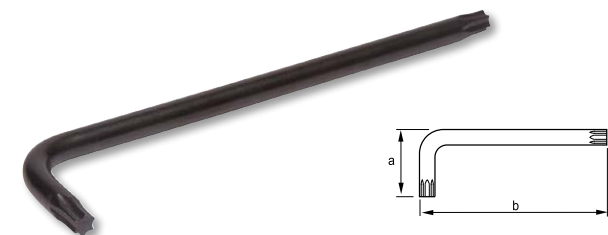

- Tamaño marcado en la varilla para fácil identificación
- La mayor longitud permite mejor accesibilidad y mayor par de transmisión

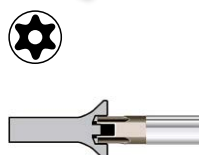

R			a mm	b mm	Ø mm	g	€
454091	5	TR9	16	80	3.0	4	5,03
454101	5	TR10	17	86	3.0	5	5,16
454151	5	TR15	18	90	4.0	8	5,30
454201	5	TR20	19	95	4.0	11	5,49
454251	5	TR25	20	100	5.0	17	5,55
454271	5	TR27	21	105	5.0	19	5,64
454301	5	TR30	24	114	6.0	29	5,73
454401	5	TR40	26	124	7.0	43	5,97

JUEGO LLAVES TIPO ALLEN PAVONADAS TORX® INVIOABLES, 9 piezas



JUEGO LLAVES TIPO ALLEN PAVONADAS TORX® INVIOABLES



- Juego de 9 llaves tipo allen pavonadas TORX® inviolables
- Medida marcada en la llave para una fácil identificación
- Agujero para colgar
- Embalaje en blíster

- Juego llaves tipo allen TORX® inviolable, 8 piezas
- Petaca bi-material resistente a impactos
- Permite trabajar en diferentes posiciones
- Tope a 270°, máximo ángulo de giro
- Embalaje en blíster

R				g	€
454-9-H	10	9	TR10, TR15, TR20, TR25, TR27, TR30, TR40, TR45, TR50	290	25,24

R				g	€
454-8-F	1	8	TR9, TR10, TR15, TR20, TR25, TR27, TR30, TR40	160	14,24



PUNTAS 1/4" PARA ATORNILLADOR

PUNTAS 1/4" PLANA, 25 MM



x10



- Cuadrado: 1/4" DIN 3126-C 6,3, ISO 1173
- Caja de plástico de 10 uds.

E					€	
475-4-1	1	0.5	4.0	25	35	6,98
475-4.5-1	1	0.6	4.5	25	35	6,98
475-5.5-1	1	0.8	5.5	25	35	6,98
475-6.0-1	1	1.0	6.0	25	35	7,09
475-6.5-1	1	1.2	6.5	25	35	7,50
475-8.0-1	1	1.6	8.0	25	35	10,94

PUNTAS 1/4" PHILLIPS, 25 MM



x10



- Cuadrado: 1/4" DIN 3126-C 6,3, ISO 1173
- Caja de plástico de 10 uds.

E					€
475-PH0-1	1	PH-0	25	35	3,99
475-PH1-1	1	PH-1	25	35	3,99
475-PH2-1	1	PH-2	25	35	3,99
475-PH3-1	1	PH-3	25	35	3,99

PUNTAS 1/4" PHILLIPS, 70 MM



x5



PUNTAS 1/4" PLANA, 70 MM



x5



- Cuadrado: 1/4" DIN 3126-C 6,3, ISO 1173
- Caja de plástico de 5 uds.

E					€	
475-70-3.0-1	1	0.5	3.0	70	70	9,25
475-70-3.5-1	1	0.6	3.5	70	70	9,31
475-70-5.5-1	1	0.8	5.5	70	77	9,48
475-70-6.5-1	1	1.2	6.5	70	80	9,82

PUNTAS 1/4" PHILLIPS, 50 MM



x5



- Cuadrado: 1/4" DIN 3126-E 6,3, ISO 1173
- Caja de plástico de 5 uds.

E					€
475-50PH1-1	1	PH-1	50	70	7,38
475-50PH2-1	1	PH-2	50	70	7,38
475-50PH3-1	1	PH-3	50	77	7,38

- Cuadrado: 1/4" DIN 3126-E 6,3, ISO 1173
- Caja de plástico de 5 uds.

E					€
475-70PH1-1	1	PH-1	70	70	9,89
475-70PH2-1	1	PH-2	70	70	9,89
475-70PH3-1	1	PH-3	70	77	9,89





PUNTAS 1/4" PARA ATORNILLADOR

PUNTAS 1/4" PHILLIPS, 89 MM



x5

PUNTAS 1/4" PHILLIPS, 150 MM



x5

- Cuadrado: 1/4" DIN 3126-E 6,3, ISO 1173
- Caja de plástico de 5 uds.

R						€
475-89PH1-1	1	PH-1	89	100	11,45	
475-89PH2-1	1	PH-2	89	100	11,45	
475-89PH3-1	1	PH-3	89	110	11,45	

- Cuadrado: 1/4" DIN 3126-E 6,3, ISO 1173
- Caja de plástico de 5 uds.

R						€
475-150PH1-1	1	PH-1	150	150	14,36	
475-150PH2-1	1	PH-2	150	150	14,36	

PUNTAS 1/4" PHILLIPS, 25 MM



x10

PUNTAS 1/4" POZIDRIV, 25 MM

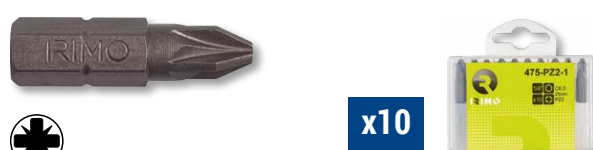

x10

- Específicos para utilizar en trabajos con yeso
- Diámetro reducido Ø 4,8 mm
- Cuadrado: 1/4" DIN 3126-C 6,3, ISO 1173
- Caja de plástico de 10 uds.

R						€
475-PH2G-1	1	PH-2G	25	35	3,99	

- Cuadrado: 1/4" DIN 3126-C 6,3, ISO 1173
- Caja de plástico de 10 uds.

R						€
475-PZ0-1	1	PZ-0	25	35	3,99	
475-PZ1-1	1	PZ-1	25	35	3,99	
475-PZ2-1	1	PZ-2	25	35	3,99	
475-PZ3-1	1	PZ-3	25	35	3,99	

PUNTAS 1/4" POZIDRIV, 50 MM



x5

- Cuadrado: 1/4" DIN 3126-C 6,3, ISO 1173
- Caja de plástico de 5 uds.

R						€
475-50PZ1-1	1	PZ-1	50	70	7,38	
475-50PZ2-1	1	PZ-2	50	70	7,38	
475-50PZ3-1	1	PZ-3	50	77	7,38	



PUNTAS 1/4" POZIDRIV, 70 MM



x5



- Cuadrado: 1/4" DIN 3126-E 6,3, ISO 1173
- Caja de plástico de 5 uds.

R			L mm	g	€
475-70PZ1-1	1	PZ-1	70	70	9,89
475-70PZ2-1	1	PZ-2	70	70	9,89
475-70PZ3-1	1	PZ-3	70	77	9,89

PUNTAS 1/4" POZIDRIV, 89 MM



x5



- Cuadrado: 1/4" DIN 3126-E 6,3, ISO 1173
- Caja de plástico de 5 uds.

R			L mm	g	€
475-89PZ1-1	1	PZ-1	89	100	11,45
475-89PZ2-1	1	PZ-2	89	100	11,45
475-89PZ3-1	1	PZ-3	89	110	11,45

PUNTAS 1/4" TORX®, 25 MM



x10



- Cuadrado: 1/4" DIN 3126-C 6,3, ISO 1173
- Caja de plástico de 10 uds. (T30/T40 en caja de 5 uds.)

R			SP mm	L mm	g	€
475-T5-1	1	T5	1.70	25	30	6,00
475-T6-1	1	T6	1.70	25	30	6,00
475-T7-1	1	T7	1.99	25	35	6,00
475-T8-1	1	T8	2.31	25	35	6,00
475-T9-1	1	T9	2.50	25	35	6,00
475-T10-1	1	T10	2.74	25	35	6,12
475-T15-1	1	T15	3.27	25	35	6,12
475-T20-1	1	T20	3.86	25	35	6,12
475-T25-1	1	T25	4.43	25	35	6,12
475-T27-1	1	T27	4.99	25	35	6,12
475-T30-1	1	x5 T30	5.52	25	40	3,23
475-T40-1	1	x5 T40	6.65	25	50	3,23
475-T45-1	1	T45	7.90	25	70	6,81
475-T50-1	1	T50	7.94	25	80	6,81

PUNTAS 1/4" POZIDRIV, 150 MM



x5



- Cuadrado: 1/4" DIN 3126-E 6,3, ISO 1173
- Caja de plástico de 5 uds.

R			L mm	g	€
475-150PZ1-1	1	PZ-1	150	150	14,36
475-150PZ2-1	1	PZ-2	150	150	14,36

PUNTAS 1/4" TORX®, 50 MM



x5



- Cuadrado: 1/4" DIN 3126-C 6,3, ISO 1173
- Caja de plástico de 5 uds.

R			SP mm	L mm	g	€
475-50T6-1	1	T6	1.70	50	38	7,56
475-50T8-1	1	T8	2.51	50	40	7,56
475-50T10-1	1	T10	2.74	50	42	7,56
475-50T15-1	1	T15	3.27	50	44	7,73
475-50T20-1	1	T20	3.86	50	46	7,73
475-50T25-1	1	T25	4.43	50	50	7,80
475-50T30-1	1	T30	5.52	50	52	7,80
475-50T40-1	1	T40	6.65	50	54	7,80

1



2



3



4



5



6



7



8



9



10



11



12





PUNTAS 1/4" PARA ATORNILLADOR

PUNTAS 1/4" TORX®, 89 MM



PUNTAS 1/4" TORX®, 150 MM



- Cuadrado: 1/4" DIN 3126-C 6,3, ISO 1173
- Caja de plástico de 5 uds.

R						
475-89T10-1	1	T10	2.74	89	80	8,72
475-89T15-1	1	T15	3.27	89	85	8,72
475-89T20-1	1	T20	3.86	89	90	8,72
475-89T25-1	1	T25	4.43	89	100	8,72
475-89T27-1	1	T27	4.99	89	100	8,72
475-89T30-1	1	T30	5.52	89	110	8,72
475-89T40-1	1	T40	6.65	89	120	8,72

- Cuadrado: 1/4" DIN 3126-C 6,3, ISO 1173
- Caja de plástico de 5 uds.

R						
475-150T10-1	1	T10	2.74	150	150	11,34
475-150T15-1	1	T15	3.27	150	150	11,34
475-150T20-1	1	T20	3.86	150	153	11,34
475-150T25-1	1	T25	4.43	150	155	11,34
475-150T30-1	1	T30	5.52	150	157	11,34
475-150T40-1	1	T40	6.65	150	160	11,34

PUNTAS 1/4" TORX® INVOLABLES, 25 MM



PUNTAS 1/4" HEXAGONALES, 25 MM



- Cuadrado: 1/4" DIN 3126-C 6,3, ISO 1173
- Caja de plástico de 5 uds.

R						
475-TR10-1	1	T10	2.74	25	35	7,07
475-TR15-1	1	T15	3.27	25	35	7,07
475-TR20-1	1	T20	3.86	25	35	7,07
475-TR25-1	1	T25	4.43	25	35	7,07
475-TR27-1	1	T27	4.99	25	35	7,07
475-TR30-1	1	T30	5.52	25	40	7,07
475-TR40-1	1	T40	6.65	25	50	7,07

- Cuadrado: 1/4" DIN 3126-C 6,3, ISO 1173
- Caja de plástico de 5 uds.

R						
475-H3-1	1	3		25	30	7,14
475-H4-1	1	4		25	35	7,14
475-H5-1	1	5		25	40	7,14
475-H6-1	1	6		25	45	7,14



PUNTA TORSIÓN PHILLIPS, 25 MM



x10



- Cuadrado: 1/4" DIN 3126-C 6,3, ISO 1173
- Acabado: Superficie de acero gris lacado transparente para mayor protección
- Material: aleación de acero de alto rendimiento
- Aplicación: puntas de torsión para materiales duros
- Zona de torsión que absorbe los picos de esfuerzo evitando desgastes y desgarros prematuros y aumentando la duración del producto
- Caja de plástico de 10 uds.

IRIMO	Icono	Tip	L mm	g	€
475T-PH1-1	1	PH-1	25	30	9,94
475T-PH2-2	1	PH-2	25	40	9,94
475T-PH3-2	1	PH-3	25	40	9,94

PUNTA TORSIÓN POZIDRIV, 25 MM



x10



- Cuadrado: 1/4" DIN 3126-C 6,3, ISO 1173
- Acabado: Superficie de acero gris lacado transparente para mayor protección
- Material: aleación de acero de alto rendimiento
- Aplicación: puntas de torsión para materiales duros
- Zona de torsión que absorbe los picos de esfuerzo evitando desgastes y desgarros prematuros y aumentando la duración del producto
- Caja de plástico de 10 uds.

IRIMO	Icono	Tip	L mm	g	€
475T-PZ1-1	1	PZ-1	25	30	9,94
475T-PZ2-2	1	PZ-2	25	40	9,94
475T-PZ3-2	1	PZ-3	25	40	9,94

PUNTA DE DIAMANTE PHILLIPS, 25 MM



x5



- Cuadrado: 1/4" DIN 3126-C 6,3, ISO 1173
- Acabado: cubierta de diamante de color dorado
- Material: aleación de acero de alto rendimiento
- Aplicación: gran rendimiento en cualquier aplicación
- Minimiza el efecto expulsión reduciendo el tiempo perdido
- Reduce desgaste de la punta y tornillo
- Zona de torsión que absorbe los picos de esfuerzo evitando desgastes y desgarros prematuros y aumentando la duración del producto
- Caja de plástico de 5 uds.

IRIMO	Icono	Tip	L mm	g	€
475D-PH1-1	1	PH-1	25	30	9,94
475D-PH2-1	1	PH-2	25	40	9,94
475D-PH3-1	1	PH-3	25	40	9,94

PUNTA DE DIAMANTE POZIDRIV, 25 MM



x5



- Cuadrado: 1/4" DIN 3126-C 6,3, ISO 1173
- Acabado: cubierta de diamante de color dorado
- Material: aleación de acero de alto rendimiento
- Aplicación: gran rendimiento en cualquier aplicación
- Minimiza el efecto expulsión reduciendo el tiempo perdido
- Reduce desgaste de la punta y tornillo
- Zona de torsión que absorbe los picos de esfuerzo evitando desgastes y desgarros prematuros y aumentando la duración del producto
- Caja de plástico de 5 uds.

IRIMO	Icono	Tip	L mm	g	€
475D-PZ1-1	1	PZ-1	25	30	9,94
475D-PZ2-1	1	PZ-2	25	40	9,94
475D-PZ3-1	1	PZ-3	25	40	9,94





PUNTAS 1/4" PARA ATORNILLADOR

PUNTA STECKER MAGNÉTICA



- Cuadrado: 1/4" DIN 3126 E 6.3 ISO 1173
- Vaso hexagonal con un fuerte imán
- Para uso general en industria
- Envase unitario para colgar

R		mm	mm	mm	mm	g	€
474M-5.5-1	1	5.5	1/4"	11.5	50	25	5,64
474M-6-1	1	6	1/4"	11	50	21	5,46
474M-7-1	1	7	1/4"	12	50	28	5,46
474M-8-1	1	8	1/4"	12.5	50	24	5,46
474M-9-1	1	9	1/4"	13.5	50	31	5,58
474M-10-1	1	10	1/4"	15.5	50	36	5,64
474M-11-1	1	11	1/4"	18.4	50	30	5,64
474M-12-1	1	12	1/4"	14.5	50	34	5,64
474M-13-1	1	13	1/4"	17	50	40	5,64

JUEGO DE 5 PUNTAS STECKER MAGNÉTICAS



- Juego de 5 puntas stecker magnéticas
- Cuadradillo 1/4" DIN 3126 E 6.3 ISO 1173
- Acero aleado de alto rendimiento
- Con imán fuerte
- Vaso hexagonal
- Embalaje en blíster

R		X	g	€
474M-5-H	1	5	134	23,84

474M-5.5-1, 474M-7-1, 474M-8-1, 474M-10-1, 474M-13-1

PUNTA STECKER MAGNÉTICA, PULGADAS



- Cuadrado: 1/4" DIN 3126 E 6.3 ISO 1173
- Vaso hexagonal con un fuerte imán
- Para uso general en industria
- Envase unitario para colgar

R		mm	mm	mm	mm	g	€
474M-1/4-1	1	1/4"	1/4"	11	50	21	6,17
474M-3/8-1	1	3/8"	1/4"	14.3	50	31	5,64

PUNTA STECKER 1/4" CON ANILLA DE RETENCIÓN



- Cuadrado: 1/4" DIN 3126-E 6,3, ISO 1173
- Acabado mate antideslizamiento
- Material: aleación de acero de alto rendimiento
- Para uso general en industria
- Vaso hexagonal
- Envase unitario para colgar

R		mm	mm	mm	mm	g	€
474MR-8-1	1	8	1/4"	12.5	50	24	5,64
474MR-10-1	1	10	1/4"	13.5	50	36	5,76



ADAPTADOR CUADRADO 1/4"



- Cuadrado: 1/4" DIN 3126-A6,3, ISO 1173
- Hexágono macho a cuadrado macho
- DIN 3120
- En bolsa unitaria

R	📦	□	⬡	L mm	g	€
475A-25-1	1	1/4"	1/4"	25	5	1,79

ADAPTADOR PARA MÁQUINA 1/4"



- Cuadrado: 1/4" DIN 3126-A6,3, ISO 1173
- Hexágono macho a cuadrado macho
- DIN 3120
- Envase unitario para colgar

R	📦	□	⬡	L mm	g	€
475A-50-1	1	1/4"	1/4"	50	18	5,57
475A-50-1/2-1	1	1/2"	1/4"	50	25	7,74

ADAPTADOR MAGNÉTICO UNIVERSAL, 1/4"



- Cuadrado: 1/4" DIN 3126-E 6,3, ISO 1173
- Fuerte imán
- DIN 3126 D 6,3
- Envase unitario para colgar

R	📦	□	⬡	L mm	g	€
475A-M-50-1	1	1/4"	1/4"	50	20	7,27
475A-M-75-1		1/4"	1/4"	75	35	7,68
475A-M-150-1	1	1/4"	1/4"	150	47	10,76

PORTAPUNTAS 1/4" CON SISTEMA DE AJUSTE RÁPIDO



- DIN 3126-E6.3, ISO 1173
- DIN 3126 D 6,3
- Imán permanente
- Envase unitario para colgar

R	📦	□	⬡	Ø mm	L mm	g	€
475A-60QR-1	1	1/4"	1/4"	14	60	15	11,34
475A-75QR-1	1	1/4"	1/4"	14	75	33	11,92

1



2



3



4



5



6



7



8



9



10



11



12





JUEGOS DE PUNTAS 1/4"

JUEGO, 32 piezas



- DIN 3126-C 6,3, ISO 1173
- En blíster
- Display 8 juegos: 475-32-8 Disp

R	X	mm	g	€	
475-32-1	1	32	30x105x65	275	12,95
475-32-8DISP	1	8	360x340x260	2.240	103,67
475-4.5-1, 475-4-1, 475-5.5-1					
2x 475-PH1-1, 2x 475-PH2-1, 2x 475-PH3-1					
475-PH2G-1					
2x 475-PZ1-1, 2x 475-PZ2-1, 2x 475-PZ3-1					
475-T10-1, 2x 475-T15-1, 2x 475-T20-1, 2x 475-T25-1, 475-T27-1, 2x 475-T30-1, 475-T40-1					
475-H3-1, 475-H4-1, 475-H5-1, 475-H6-1					
475A-25-1					
105-48-1					
475A-60QR-1					

JUEGO, 32 piezas



- Juego de puntas de 32 piezas: 30 puntas, 1 portapuntas magnético de liberación rápida y 1 destornillador portapuntas para brocas intercambiables
- DIN 3126, ISO 1173, estilo C 6.3
- Sistema para bloqueo fácil y seguro, magnético. La punta permanece sujeta hasta que se indica su liberación
- Puntas de gran dureza, de acabado granallado
- Portapuntas de liberación rápida con fuerte imán (estilo E 6.3)
- Robusta caja de plástico con asa. Tapa transparente
- Para uso universal
- Aleación de acero de alto rendimiento
- En blíster

R	X	mm	g	€	
475-32A-1	6	32	153x35x100	375	28,26
475A-60QR-1					
475-4.5-1, 475-5.5-1, 475-6.5-1					
3x 475-PH1-1, 3x 475-PH2-1, 3x 475-PH3-1					
3x 475-PZ1-1, 3x 475-PZ2-1, 3x 475-PZ3-1					
475-H4-1, 475-H5-1, 475-H6-1					
475-T10-1, 475-T15-1, 475-T20-1, 475-T25-1, 475-T30-1, 475-T40-1					



JUEGO DE PUNTAS 1/4" TORX®



- Juego de 8 puntas TORX® y 1 portapuntas magnético de liberación rápida
- Hexágono 1/4". DIN 3126, ISO 1173, tipo C 6.3
- Puntas robustas
- Portapuntas magnético de liberación rápida (tipo E 6.3)
- El tamaño del juego es ideal para llevar en un bolsillo. Fácil de abrir y cerrar
- Para uso universal
- Aleación de acero de alto rendimiento
- Embalaje en blister

IRIMO	Paquete	Contenido	Tamaño (mm)	Peso (g)	Precio (€)
475-9-1	1	9	40x20x97	129	8,08
475A-60QR-1					
475-T10-1, 475-T15-1, 2x 475-T20-1, 2x 475-T25-1, 475-T30-1, 475-T40-1					

JUEGO, 61 piezas



- DIN 3126-C 6,3, ISO 1173
- Envasado en blíster

IRIMO	Paquete	Contenido	Tamaño (mm)	Peso (g)	Precio (€)
475-61-1	1	61	35 x 148 x 112	549	23,00
475-4.5-1, 475-4-1, 475-5.5-1, 475-6.0-1, 475-6.5-1, 475-8.0-1					
475-PH0-1, 2x 475-PH1-1, 3x 475-PH2-1, 2x 475-PH3-1					
2x 475-PH2G-1					
475-PZ0-1, 2x 475-PZ1-1, 3x 475-PZ2-1, 2x 475-PZ3-1					
475-T6-1, 475-T7-1, 475-T8-1, 475-T9-1, 2x 475-T10-1, 2x 475-T15-1, 3x 475-T20-1, 2x 475-T25-1, 2x 475-T27-1, 2x 475-T30-1, 2x 475-T40-1					
475-TR10-1, 475-TR15-1, 475-TR20-1, 475-TR25-1, 475-TR27-1, 475-TR30-1, 475-TR40-1					
475-H3-1, 475-H4-1, 475-H5-1, 475-H6-1					
475A-25-1					
R-1, R-2, R-3					
475A-60QR-1					

SET DESTORNILLADOR DE PRECISIÓN PARA APLICACIONES DE INGENIERÍA Y ELECTRÓNICA

DESTORNILLADOR DE PRECISIÓN CON PORTAPUNTAS A CARRACA, 17 piezas



- Cuadradillo: 5/32" DIN 3126-C 4, ISO 1173
- Puntas de acero de cromo vanadio, gran duración y precisión
- Mango bi-material
- Cabeza giratoria para mayor facilidad y precisión
- Imán en la cabeza que permite asegurar la punta en el destornillador
- Suave movimiento de carraca: mecanismo de tres posiciones:
- Delantera, trasera y neutral
- Embalaje en blíster

IRIMO	Paquete	Contenido	Tamaño (mm)	Peso (g)	Precio (€)
471-18-1	1	17	35 x 95 x 130	220	19,14
x3	①	SL: 1-1.5-2 mm	x3	⊕	PH000-PH00-PH0
x5	⊕	T2-T3-T4-T5-T6	x2	⊕	0.8-1.2
x2	⊕	Y 2.0-3.0	x1	⊕	U 2.6
x1	⊕	2.3	x1	⊕	





PUNTAS 5/16"

PUNTAS 5/16" RANURADAS



x2

- DIN 3126-C 8, ISO 1173
- Acabado: Zinc fosfatado
- En bolsas de 2 uds.

€		mm	mm	L mm	g	€
470-5.5-1	1	1.0	5.5	36	18	5,74
470-6.5-1	1	1.2	6.5	36	20	5,86
470-8.0-1	1	1.2	8.0	36	22	6,23
470-10.0-1	1	1.6	10.0	36	30	8,24
470-12.0-1	1	2.0	12.0	36	36	8,45
470-14.0-1	1	2.5	14.0	36	38	11,26

PUNTAS 5/16" PHILLIPS



x2

- DIN 3126-C 8, ISO 1173
- Acabado: Zinc fosfatado
- En bolsas de 2 uds.

€			L mm	g	€
470-PH1-1	1	PH-1	36	22	3,91
470-PH2-1	1	PH-2	36	24	3,91
470-PH3-1	1	PH-3	36	25	3,91
470-PH4-1	1	PH-4	36	28	4,90

PUNTAS 5/16" HEXAGONALES



x2

- DIN 3126-C 8, ISO 1173
- Acabado: Zinc fosfatado
- En bolsas de 2 uds.

€		mm	L mm	g	€
470-H4-1	1	4	36	25	4,68
470-H5-1	1	5	36	26	4,68
470-H6-1	1	6	36	27	4,68
470-H7-1	1	7	36	28	4,68
470-H8-1	1	8	36	29	4,68
470-H10-1	1	10	36	36	6,76

PUNTAS 5/16" TORX®

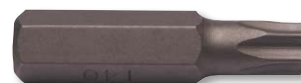

x2

- DIN 3126-C 8, ISO 1173
- Acabado: Zinc fosfatado
- En bolsas de 2 uds.

€			mm	L mm	g	€
470-T20-1	1	T20	3.86	36	21	5,02
470-T25-1	1	T25	4.43	36	22	5,02
470-T27-1	1	T27	4.99	36	24	5,02
470-T30-1	1	T30	5.52	36	24	5,02
470-T40-1	1	T40	6.65	36	27	5,02
470-T45-1	1	T45	7.82	36	27	5,02
470-T50-1	1	T50	8.83	36	27	5,86
470-T55-1	1	T55	11.22	36	28	6,79



DESTORNILLADOR A GOLPE 5/16"

DESTORGOLPE



- Para girar tornillos atorados
- Cuadrado de 1/2", puntas 5/16"
- Reversible colocando adaptador

€	📦	L mm	C mm	A mm	L1 mm	g	€
470011	1	125	33	24	40	650	29,40

ADAPTADOR



- Acabado: cromado plateado
- Cuadrado 1/2"
- Para puntas 5/16"
- Con anilla de retención

€	📦	L mm	g	€
470051	1	40	54	6,82

JUEGO DE DESTORNILLADOR A GOLPE



- Destornillador de impacto 1/2"
- Adaptador portapuntas hexágono 5/16" y cuadrado 1/2"
- 18 puntas 5/16"
- En caja metálica

€	📦	📏	g	€
471011	1	197 x 70 x 45	1.280	60,47
470-8.0-1, 470-10.0-1, 470-12.0-1				🔩
470-PH2-1, 470-PH3-1, 470-PH4-1				⊕
470-H4-1, 470-H5-1, 470-H6-1, 470-H7-1, 470-H8-1, 470-H10-1				●
470-T25-1, 470-T27-1, 470-T30-1, 470-T40-1, 470-T45-1, 470-T50-1				✳
470011				○

1



2



3



4



5



6



7



8



9



10



11



12





PUNTAS 10 MM

PUNTA HEXAGONAL



- Acabado zinc fosfatado
- Envase individual

Artículo	Paquete	mm	L mm	g	€
T49H4	1	4	30	5	2,75
T49H5	1	5	30	6.5	2,75
T49H6	1	6	30	7	2,75
T49H7	1	7	30	7	2,75
T49H8	1	8	30	7	2,75
T49H10	1	10	30	7	2,75
T49H12	1	12	30	12	3,26
T49H14	1	14	30	14	5,13
T49H4L	1	4	75	20	4,09
T49H5L	1	5	75	20	4,09
T49H6L	1	6	75	20	4,09
T49H7L	1	7	75	20	4,09
T49H8L	1	8	75	20	4,09
T49H10L	1	10	75	20	4,09
T49H12L	1	12	75	20	5,13
T49H10XL	1	10	115	75	6,88

PUNTA TORX®



- Acabado zinc fosfatado
- Envase individual

Artículo	Paquete	Tamaño	mm	L mm	g	€
T49T20	1	T20	3.84	30	6.5	2,63
T49T25	1	T25	4.4	30	6.5	2,63
T49T27	1	T27	4.96	30	6.5	2,63
T49T30	1	T30	5.49	30	6.5	2,63
T49T40	1	T40	6.6	30	6.5	2,63
T49T45	1	T45	7.7	30	6.5	2,63
T49T50	1	T50	8.79	30	6.5	2,63
T49T55	1	T55	11.17	30	6.5	2,63
T49T60	1	T60	13.2	30	6.5	4,07
T49T20L	1	T20	3.84	75	20	3,88
T49T25L	1	T25	4.4	75	20	3,88
T49T27L	1	T27	4.96	75	20	3,88
T49T30L	1	T30	5.49	75	20	3,88
T49T40L	1	T40	6.6	75	20	3,88
T49T45L	1	T45	7.7	75	20	3,88
T49T50L	1	T50	8.79	75	20	3,88
T49T55L	1	T55	11.17	75	20	3,88
T49T60L	1	T60	13.2	75	20	5,32
T49T55XL	1	T55	11.17	115	75	7,15

ADAPTADOR DE 1/2" PARA PUNTAS



- Adaptador de 1/2" para puntas 10 mm
- Acabado zinc fosfatado
- Envase individual

Artículo	Paquete	mm	L mm	D1 mm	D2 mm	g	€
T4901	1	10	36	17	22	55	7,15

ADAPTADOR DE 3/8" PARA PUNTAS



- Adaptador de 3/8" para puntas 10 mm
- Acabado zinc fosfatado
- Envase individual

Artículo	Paquete	mm	L mm	D1 mm	D2 mm	g	€
T4902	1	10	35	15	10	32	6,14



PUNTA TORX® INVIOLEBLE



- Acabado zinc fosfatado
- Envase individual

R				L mm	g	€
T49T20H	1	TR20	3.84	30	6.5	2,75
T49T25H	1	TR25	4.4	30	6.5	2,75
T49T27H	1	TR27	4.96	30	6.5	2,75
T49T30H	1	TR30	5.49	30	6.5	2,75
T49T40H	1	TR40	6.6	30	6.5	2,75
T49T45H	1	TR45	7.7	30	6.5	2,75
T49T50H	1	TR50	8.79	30	6.5	2,75
T49T55H	1	TR55	11.17	30	6.5	2,75
T49T60H	1	TR60	13.2	30	6.5	4,28
T49T20HL	1	TR20	3.84	75	20	4,09
T49T25HL	1	TR25	4.4	75	20	4,09
T49T27HL	1	TR27	4.96	75	20	4,09
T49T30HL	1	TR30	5.49	75	20	4,09
T49T40HL	1	TR40	6.6	75	20	4,09
T49T45HL	1	TR45	7.7	75	20	4,09
T49T50HL	1	TR50	8.79	75	20	4,09
T49T55HL	1	TR55	11.17	75	20	4,09
T49T60HL	1	TR60	13.2	75	20	5,61

PUNTA XZN



- Acabado zinc fosfatado
- Envase individual

R			L mm	g	€
T49M5	1	M5	30	6.5	2,75
T49M6	1	M6	30	7	2,75
T49M8	1	M8	30	7	2,75
T49M10	1	M10	30	8.5	2,75
T49M12	1	M12	30	10	3,26
T49M14	1	M14	30	20	4,33
T49M5L	1	M5	75	15	4,09
T49M6L	1	M6	75	15	4,09
T49M8L	1	M8	75	15	4,09
T49M10L	1	M10	75	15	4,09
T49M12L	1	M12	75	15	5,13

PUNTA CUADRADA



- Acabado zinc fosfatado
- Envase individual

R			L mm	g	€
T49SQ8	1	8	30	17	4,02
T49SQ10	1	10	30	22	4,82

1



2



3



4



5



6



7



8



9



10



11



12





VASOS CON PUNTA 1/2"

VASOS 1/2" CON PUNTA TORX® INVIOLEABLE



- Vasos con punta 1/2" TORX® inviolable
- Acabado zinc fosfatado
- Envase individual

R	📦	♻️	□	L mm	L1 mm	g	€
T49T30XL	1	TR30	1/2"	200	160	122	10,36
T49T40XL	1	TR40	1/2"	200	160	123	10,36
T49T45XL	1	TR45	1/2"	200	160	125	10,36
T49T70HL	1	TR70	1/2"	100	60	167	18,55
T49T80HL	1	TR80	1/2"	100	30	163	18,55

JUEGO DE VASOS CON PUNTA Y PUNTAS DE 10 MM, 49 piezas



- Acabado zinc fosfatado
- Caja metálica

R	📦	📦	📦	g	€
T49	1	49	60 x 195 x 325	3.600	103,72
T4901					
T4902					
T49T30XL, T49T40XL, T49T45XL, T49T70HL, T49T80HL					
T49H4, T49H4L, T49H5, T49H5L, T49H6, T49H6L, T49H7, T49H7L, T49H8, T49H8L, T49H10, T49H10L, T49H12, T49H12L					
T49M5, T49M5L, T49M6, T49M6L, T49M8, T49M8L, T49M10, T49M10L, T49M12, T49M12L					
T49T20H, T49T20HL, T49T25H, T49T25HL, T49T27H, T49T27HL, T49T30H, T49T30HL, T49T40H, T49T40HL, T49T45H, T49T45HL, T49T50H, T49T50HL, T49T55H, T49T55HL, T49T60H, T49T60HL					



08. HERRAMIENTAS DE GOLPEO



GOLPEO

CORTAFRIOS

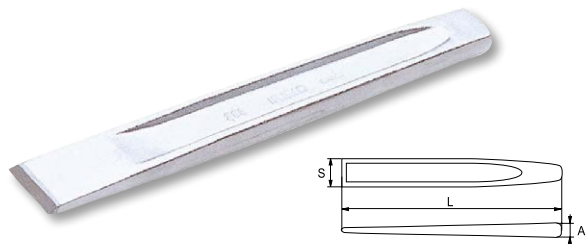

- Cromo vanadio
- UNE 16567

R		L mm	S mm	A mm	g	€
501-150-1	25	150	18	10	133	9,33
501-175-1	25	175	21	11	192	9,22
501-200-1	25	200	22	12	243	12,44
501-250-1	20	250	25	13	357	15,98
501-300-1	25	300	26	14	552	21,76

CORTAFRIOS PLANO

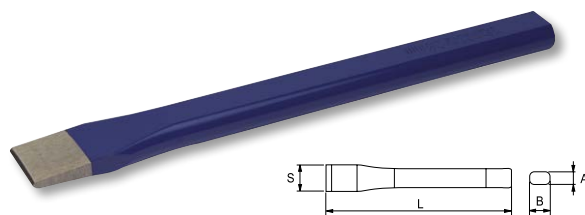

- Cromo molibdeno vanadio
- Acabado: Lacado, pintado en azul
- Plano con laterales ovalados
- DIN 7250

R		L mm	S mm	AxB mm	g	€
504-150-1	10	150	21	11x17	181	8,76
504-175-1	10	175	24	12x20	269	11,62
504-200-1	10	200	28	13x23	390	12,21
504-250-1	10	250	28	13x23	500	14,51
504-300-1	10	300	32	13x26	602	16,56

CORTAFRIOS PLANO

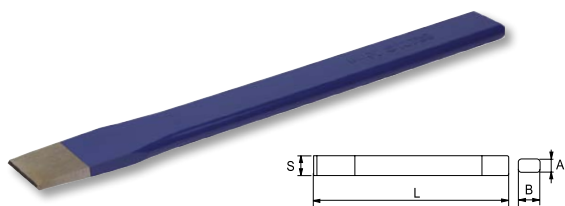

- Cromo molibdeno vanadio
- Acabado: Lacado, pintado en azul
- Plano con laterales ovalados

R		L mm	S mm	A mm	B mm	g	€
502-230-1	10	230	26	7	26	285	12,91

CORTAFRIOS EXTRAPLANO

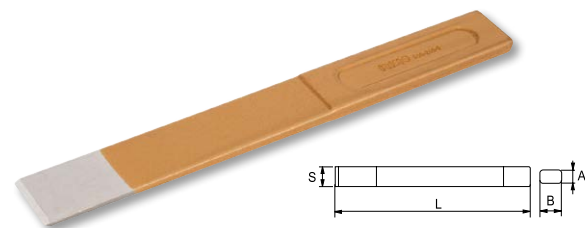

- Cortafrios extraplano
- Cromo molibdeno vanadio
- Plano con laterales ovalados

R		L mm	S mm	A mm	B mm	g	€
500-240-1	10	230	26	4	26	278	15,02

BURIL NERVADO

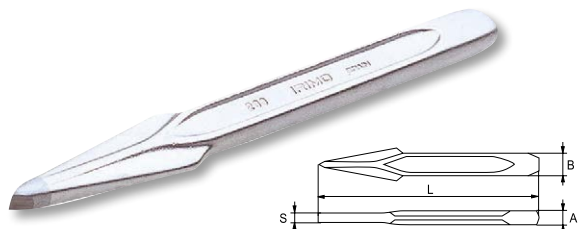

- Cromo vanadio
- UNE 16568

R		L mm	S mm	AxB mm	g	€
505-150-1	5	150	6.5	11x17	129	7,67
505-200-1	5	200	8.5	12x21	241	10,55
505-250-1	5	250	9.5	14x24	404	15,55

BURIL PLANO

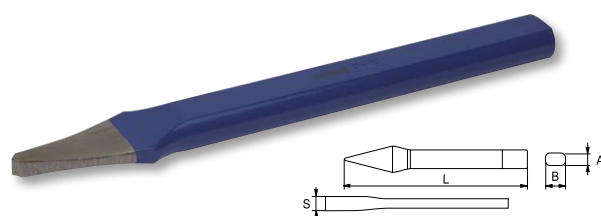

- Cromo molibdeno vanadio
- Acabado: Lacado, pintado en azul
- Plano con laterales ovalados
- DIN 7250

R		L mm	S mm	AxB mm	g	€
506-150-1	10	150	6	11x17	152	8,87
506-175-1	10	175	7	12x20	231	11,34
506-200-1	10	200	8	13x23	335	12,03



GRANETE REDONDO

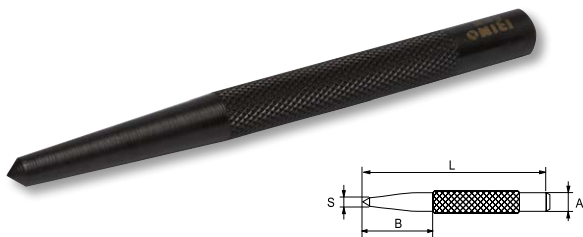

- Acabado: Pavonado
- UNE 16574

E		S mm	L mm	A mm	B mm	g	€
511-100-1	25	2.5	100	8	35	31	3,47
511-105-1	25	4	105	8	35	34	3,47
511-110-1	25	5	110	8	40	37	3,47
511-115-1	25	6	115	10	45	60	3,89
511-130-1	20	8	130	12	50	98	4,61

GRANETE OCTOGONAL

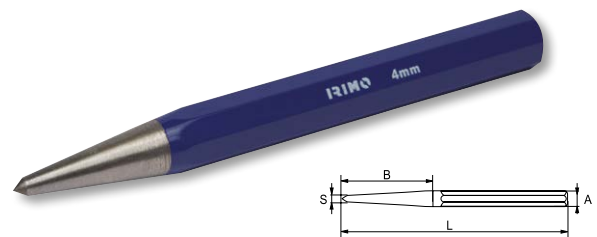

- Cromo molibdeno vanadio
- Acabado: Lacado, pintado en azul
- Perfil octogonal
- DIN 7250

E		S mm	L mm	A mm	B mm	g	€
512-010-1	25	4	120	10	40	62	3,47
512-012-1	25	5	120	12	40	88	4,31

JUEGOS DE GRANETES REDONDOS



E				g	€
511-91-4	1	4	2.5 - 4 - 6 - 8 mm	234	15,44
511-92-4	1	5	2.5 - 4 - 5 - 6 - 8 mm	275	18,97

BOTADOR CÓNICO REDONDO

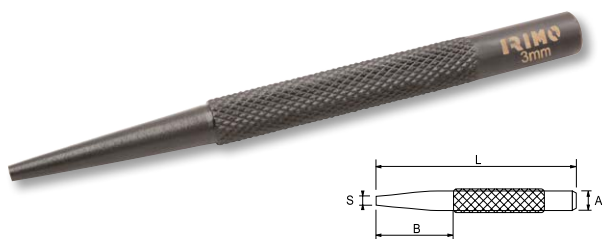

- Acabado: Pavonado
- UNE 16576

E		S mm	L mm	A mm	B mm	g	€
513-002-1	25	2	100	8	35	31	3,28
513-003-1	25	3	100	8	35	32	3,28
513-004-1	25	4	115	10	45	55	3,47
513-005-1	25	5	115	10	45	59	3,47
513-006-1	20	6	130	12	50	94	4,14
513-008-1	20	8	150	12	55	117	4,51
513-010-1	20	10	170	14	60	183	6,05

BOTADOR CÓNICO OCTOGONAL

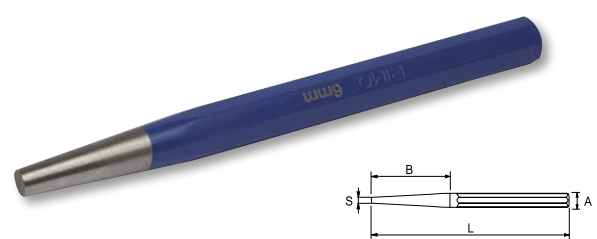

- Cromo molibdeno vanadio
- Acabado: Lacado, pintado en azul
- Perfil octogonal
- DIN 6458

E		S mm	L mm	A mm	B mm	g	€
514-002-1	25	2	120	10	40	60	3,30
514-003-1	25	3	120	10	40	60	3,30
514-004-1	25	4	120	10	40	62	3,50
514-005-1	25	5	120	10	40	64	3,50
514-006-1	25	6	120	12	40	93	4,18

1



2



3



4



5



6



7



8



9



10



11



12





GOLPEO

JUEGO DE BOTADORES CÓNICOS



IRIMO	Paquete	Caja	Diagrama	g	€
513-91-4	1	5	2-4-6-8-10 mm	502	21,45
513-92-4	1	7	2-3-4-5-6-8-10 mm	602	28,19

JUEGO DE BOTADORES CÓNICOS, PERFIL OCTOGONAL



IRIMO	Paquete	Caja	Diagrama	g	€
519-91-4	1	6	150x80x12	409	20,19
2-3-4-5-6 mm					
4 mm					

BOTADOR CILÍNDRICO REDONDO

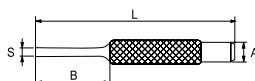

- Acabado: Pavonado
- UNE 16575

IRIMO	Paquete	S mm	L mm	A mm	B mm	g	€
515-002-1	25	2	100	8	28	29	3,78
515-003-1	25	3	100	8	28	30	3,78
515-004-1	25	4	100	8	28	31	3,78
515-005-1	25	5	115	10	33	53	3,89
515-006-1	25	6	115	10	33	55	3,89
515-007-1	25	7	115	10	33	58	3,89
515-008-1	20	8	130	12	43	91	4,71
515-009-1	20	9	130	12	43	96	4,71
515-010-1	20	10	130	14	53	143	5,88

BOTADOR CILÍNDRICO OCTOGONAL

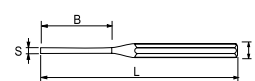

- Cromo molibdeno vanadio
- Acabado: Lacado, pintado en azul
- Perfil octogonal
- DIN 6450

IRIMO	Paquete	S mm	L mm	A mm	B mm	g	€
516-002-1	20	2	150	10	35	63	5,30
516-003-1	20	3	150	10	40	63	5,30
516-004-1	20	4	150	10	50	63	5,30
516-005-1	20	5	150	10	50	64	5,30
516-006-1	20	6	150	10	50	70	5,30
516-008-1	20	8	150	12	55	106	5,99



JUEGO BOTADORES CILÍNDRICOS



519-91-4	1	9	2-3-4-5-6-7-8-9-10 mm	622	26,94

JUEGO BOTADORES CILÍNDRICOS, PERFIL OCTOGONAL



519-92-4	1	6	2-3-4-5-6-8 mm	409	32,50

BOTADOR CILÍNDRICO REDONDO, LARGO

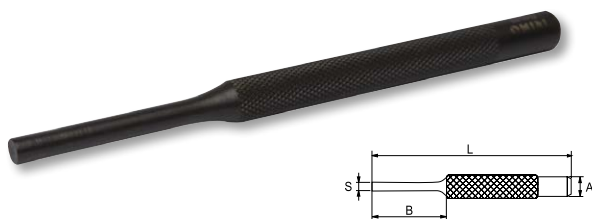

- Acabado: Pavonado
- UNE 16575

		S mm	L mm	A mm	B mm	g	€
517-120-1	25	2	120	8	30	33	3,94
517-130-1	25	3	130	8	40	35	4,06
517-135-1	25	4	135	8	45	37	4,13
517-140-1	25	5	140	10	50	60	4,21
517-145-1	20	6	145	10	55	64	4,31
517-150-1	20	8	150	12	60	100	4,67

BOTADOR CILÍNDRICO OCTOGONAL, LARGO

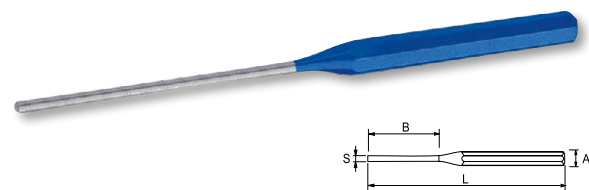

- Acabado: Lacado, pintado en azul
- Perfil octogonal
- Serie larga

		S mm	L mm	A mm	B mm	g	€
518-004-1	20	4	175	10	80	61	5,96
518-006-1	20	6	175	10	80	72	5,96

JUEGO BOTADORES CILÍNDRICOS, SERIE LARGA



517-91-4	1	6	2-3-4-5-6-8 mm	355	25,34

1



2



3



4



5



6



7



8



9



10



11



12





GOLPEO

CORTAFRÍOS ELECTRICISTA

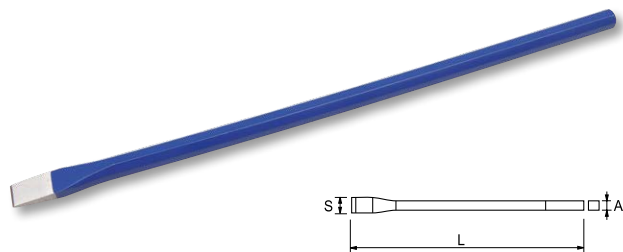

- Acabado: Lacado, pintado en azul
- Cromo molibdeno vanadio

IRIMO	Paquete	L mm	S mm	A mm	g	€
503-200-1	20	200	12	8	93	6,24
503-250-1	20	250	12	8	119	6,50
503-300-1	20	300	12	8	142	7,47

JUEGO BOTADORES Y CINCELES, 6 piezas



IRIMO	Paquete	Paquete	Paquete	Paquete	g	€
519-93-4	1	6	160x85x12 mm		600	32,99
504-150-1						
506-150-1						
512-010-1						
514-003-1, 514-004-1						
516-005-1						

TRAZADOR PUNTA DURA



- Adecuado para el marcado en superficies duras
- Longitud total 150 mm

IRIMO	Paquete	L mm	g	€
511501	1	150	39	5,98

BARRA PARA DESENCOFRADOR



- Herramienta para industria pesada
- Permite el acceso a espacios reducidos
- Con garra especialmente diseñada para facilitar la extracción
- Acabado liso y pintura de alta calidad para un uso cómodo

IRIMO	Paquete	Ø mm	L mm	g	€
WB-300-2	1	14	346	450	30,32
WB-500-2	1	16	487	1.100	31,30
WB-625-2	1	17	685	1.450	35,35
WB-710-2	1	17	704	1.950	37,36
WB-900-2	1	20	890	2.850	40,20



MARTILLOS

MARTILLO DE CARPINTERO CON MANGO DE MADERA HICKORY



- El mango se une a la cabeza con dos cuñas metálicas y una de madera

E	Paquete	oz	g	A mm	B mm	L mm	g	€
520-41-2	6	16	450	29	130	330	710	16,55
520-61-2	6	20	560	30	140	333	820	17,28

REPUESTO DE MANGO DE MADERA HICKORY PARA MARTILLO DE CARPINTERO



- Suministrado con sus correspondientes cuñas

E	Paquete	g	€
520-42-2	12	520-41-2 / 520-61-2	160 6,16

MARTILLO DE UÑA CON MANGO DE MADERA HICKORY



- Mango cónico

E	Paquete	g	A mm	B mm	L mm	g	€
521-51-2	6	350	28.2	107.3	330	500	16,52
521-71-2	6	475	31.1	118.3	330	625	18,02
521-81-2	6	550	31.6	125.5	330	700	19,53

MANGO DE MADERA HICKORY PARA MARTILLO DE UÑA



- Mango de madera cónico

E	Paquete	g	€
521-52-2	18	521-51-2 / 521-71-2	160 9,30
521-82-2	18	521-81-2	160 9,46

MARTILLO DE CARPINTERO CON MANGO DE FIBRA



- Mango encolado a la cabeza
- Mango trimaterial con el interior de fibra y recubierto de polipropileno y elastómero para un buen agarre

E	Paquete	oz	g	A mm	B mm	L mm	g	€
520-43-2	6	16	450	29	130	330	710	18,21
520-63-2	6	20	560	30	140	333	820	19,00

MARTILLO DE CARPINTERO DE BOLSILLO



- Cabeza pegada al mango con resina especial
- Mango trimaterial con el interior de fibra y recubierto de polipropileno y elastómero para un buen agarre
- Alojamiento en la cabeza imantado para clavos

E	Paquete	oz	g	A mm	B mm	L mm	g	€
520-13S-1	6	8	227	23	105	160	300	10,03

MARTILLO DE UÑA CON MANGO DE FIBRA VIDRIO



- Mango trimaterial con el interior de fibra y recubierto de polipropileno y elastómero para un buen agarre

E	Paquete	g	A mm	B mm	L mm	g	€
521-53-2	6	350	28.2	107.3	330	500	15,78
521-73-2	6	475	31.1	118.3	330	625	16,88
521-83-2	6	550	31.6	125.5	327	700	17,99

MANGO DE FIBRA PARA MARTILLO DE UÑA



- Mango trimaterial con el interior de fibra y recubierto de polipropileno y elastómero para un buen agarre

E	Paquete	g	€
521-54-2	18	521-53-2 / 521-73-2	160 6,44
521-84-2	18	521-83-2	160 6,58

1



2



3



4



5



6



7



8



9



10



11



12





MARTILLOS

MARTILLO DE PEÑA
CON MANGO DE MADERA HICKORY



- Mango unido a la cabeza con cuña metálica redonda

R	g	A mm	B mm	L mm	g	€	
522-21-2	12	170	20	91	282	270	12,02
522-31-2	6	270	25	107	291	380	15,02
522-41-2	6	460	30	120	311	680	18,02

MARTILLO PARA MECÁNICO TIPO ALEMÁN DIN
CON MANGO MADERA HICKORY



- Mango unido a la cabeza con cuña metálica redonda

R	g	A mm	B mm	L mm	g	€	
525-11-2	6	100	17	90	270	250	5,65
525-21-2	6	200	19	95	280	280	12,52
525-31-2	6	300	23	105	300	420	13,81
525-41-2	6	500	27	118	320	650	18,79
525-61-2	6	800	33	130	350	990	22,98
525-71-2	4	1.000	36	135	360	1.220	26,29
525-81-2	4	1.500	42	145	380	1.790	30,36
525-91-2	4	2.000	45	150	380	2.300	21,06

MANGO DE MADERA HICKORY PARA
MARTILLO DE PEÑA



- Suministrado con una cuña redonda

R	g	€		
522-22-2	18	522-21-2	63	6,83
522-32-2	18	522-31-2	100	8,56
522-42-2	18	522-41-2	140	8,86

MANGO MADERA HICKORY PARA
MARTILLO TIPO ALEMÁN DIN



- Suministrado con una cuña metálica redonda

R	g	€		
525-12-2	12	525-11-2	96	2,67
525-22-2	12	525-21-2	86	4,05
525-32-2	12	525-31-2	93	5,26
525-42-2	12	525-41-2	136	6,62
525-62-2	12	525-61-2	212	7,82
525-72-2	12	525-71-2	260	8,72
525-82-2	12	525-81-2	298	9,46
525-92-2	12	525-91-2	344	10,08

MARTILLO DE PEÑA
CON MANGO DE FIBRA VIDRIO



- Mango encolado a la cabeza
- Mango trimaterial con el interior de fibra y recubierto de polipropileno y elastómero para un buen agarre

R	g	A mm	B mm	L mm	g	€	
522-23-2	12	170	20	91	282	270	12,61
522-33-2	6	270	25	107	291	380	15,78
522-43-2	6	460	30	120	311	680	18,93

MARTILLO PARA MECÁNICO TIPO ALEMÁN DIN
CON MANGO DE FIBRA VIDRIO



- Mango encolado a la cabeza
- Mango trimaterial con el interior de fibra y recubierto de polipropileno y elastómero para un buen agarre

R	g	A mm	B mm	L mm	g	€	
525-43-2	6	500	27	118	330	735	20,67



**MARTILLO RIVOIR
CON MANGO DE MADERA HICKORY**



- Mango unido a la cabeza con cuña metálica redonda

R	Paquete	g	A mm	B mm	L mm	g	€
526-31-2	4	250	25	81.5	265	350	12,10
526-41-2	4	400	30	92	280	520	13,47
526-51-2	4	630	35	103	300	800	17,24
526-61-2	4	800	40	110	330	1.000	19,98
526-71-2	4	1.150	45	124	350	1.400	23,13
526-91-2	4	2.000	50	138	380	2.250	23,37

**MANGO DE MADERA HICKORY PARA
MARTILLO RIVOIR**



- Suministrado con su correspondiente cuña metálica redonda

R	Paquete	g	€
526-32-2	12	526-31-2	93 4,05
526-42-2	12	526-41-2	136 4,51
526-52-2	12	526-51-2	212 6,16
526-62-2	12	526-61-2	260 7,51
526-72-2	12	526-71-2	298 9,46
526-92-2	12	526-91-2	344 10,36

MARTILLO RIVOIR CON MANGO DE FIBRA VIDRIO



- Mango encolado a la cabeza
- Mango trimaterial con el interior de fibra y recubierto de polipropileno y elastómero para un buen agarre

R	Paquete	g	A mm	B mm	L mm	g	€
526-53-2	6	630	35	103	330	630	18,97

**MARTILLO DE BOLA
CON MANGO DE MADERA HICKORY**



- Mango unido a la cabeza con dos cuñas metálicas y una de madera

R	Paquete	oz	g	A mm	B mm	L mm	g	€
527-31-2	6	B	12	340	27	87	318	440 12,42
527-41-2	6	C	16	455	30	97	318	560 14,23
527-51-2	6	D	20	560	33	106	318	720 16,31
527-61-2	6	E	24	680	35	116	343	920 16,91
527-71-2	6	F	32	910	37	127	343	1.148 17,59
527-81-2	6	G	40	1.135	38	134	378	1.400 19,00
527-91-2	6	H	48	1.360	40	144	385	1.640 21,02

REPUESTO DE MANGO DE MADERA HICKORY PARA MARTILLO DE BOLA



- Suministrado con sus dos cuñas metálicas y una de madera

R	Paquete	g	€
527-32-2	18	527-31-2 (B) / 527-41-2 (C) / 527-51-2 (D)	100 7,07
527-52-2	12	527-61-2 (E) / 527-71-2 (F)	160 10,07
527-82-2	12	527-81-2 (G) / 527-91-2 (H)	220 10,97

MARTILLO DE BOLA CON MANGO FIBRA DE VIDRIO



- Mango encolado a la cabeza
- Mango trimaterial con el interior de fibra y recubierto de polipropileno y elastómero para un buen agarre

R	Paquete	oz	g	A mm	B mm	L mm	g	€
527-33-2	6	B	12	340	27	90	317	500 13,66
527-43-2	6	C	16	455	30	100	320	600 15,65
527-53-2	6	D	20	560	33	108	324	760 17,93
527-63-2	6	E	24	680	35	120	335	920 18,15
527-73-2	6	F	32	910	37	131	337	1.148 19,35
527-83-2	6	G	40	1.135	38	139	387	1.400 20,91
527-93-2	6	H	48	1.360	40	148	390	1.640 23,13

1



2



3



4



5



6



7



8



9



10



11



12





MARTILLOS

MACETA DE ALBAÑIL CON MANGO DE MADERA HICKORY



- Mango unido a la cabeza con dos cuñas metálicas redondas y una de madera recta

R	g	A mm	B mm	L mm	g	€
530-03-2	6	700	35	110	280	800 14,12
530-05-2	6	1.000	38	120	280	1.200 15,68
530-07-2	6	1.250	43	135	280	1.400 17,53

MACETA CON MANGO DE MADERA HICKORY



- Mango unido a la cabeza con cuña metálica redonda

R	g	A mm	B mm	L mm	g	€
531-05-2	6	1.000	40	95	260	1.155 21,78
531-07-2	6	1.250	43	100	260	1.405 22,53
531-08-2	4	1.500	45	110	280	1.675 23,28
531-09-2	2	2.000	50	120	300	2.235 26,29

MANGO DE MADERA HICKORY PARA MACETA



- Suministrado con dos cuñas metálicas redondas y una de madera recta

R	g	€
530-13-2	12	530-03-2 145 9,89
530-15-2	12	530-05-2 / 530-07-2 159 9,89

MANGO DE MADERA PARA MACETA



- Suministrado con una cuña metálica redonda

R	g	€
531-15-2	12	531-05-2 165 5,55
531-17-2	12	531-07-2 168 5,55
531-18-2	12	531-08-2 205 7,82
531-19-2	12	531-09-2 231 7,82

MAZA DE GOMA

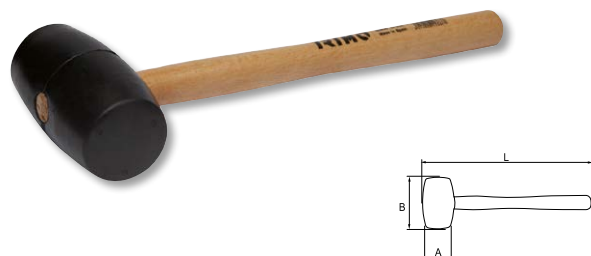

- Para colocación de suelos y paredes

R	A mm	B mm	L mm	g	€
529251	1	55	90	320	250 6,93
529261	1	65	115	340	440 8,33
529271	1	75	125	360	600 11,09
529291	1	90	139	360	720 12,52



MARTILLO ANTIRREBOTE



• Mango de madera

R		S mm	A mm	L mm	g	€
529611	6	35	115	370	500	24,87
529621	6	50	120	390	1.000	41,10
529631	6	60	125	420	1.560	53,48

BOCAS DE REPUESTO PARA MARTILLO ANTIRREBOTE



• Compatible con 529611, 529621 y 529631

R		A mm	L mm	g	€
529701	6	25	35	20	2,61
529711	6	28	50	50	4,15
529721	6	30	60	60	5,75

MANGO MADERA PARA MARTILLO ANTIRREBOTE



• Mango martillo antirrebote

R			g	€
529801	1	529611	90	3,09
529811	1	529621	140	3,32
529821	1	529631	215	3,38

MARTILLO BOCA NYLON



• Mango metálico, empuñadura de caucho

R		S mm	A mm	L mm	g	€
529021	6	28	80	255	325	16,40
529031	6	35	100	285	650	21,87
529041	6	44	125	300	1.105	30,94

MARTILLO BOCA NYLON



• Mango de madera

R		S mm	A mm	L mm	g	€
529151	6	22	65	215	145	7,67
529161	6	28	80	270	260	10,95
529171	6	35	100	295	500	13,61
529181	6	44	125	345	1.010	20,13
529191	6	55	140	380	1.480	38,74

BOCAS DE REPUESTO PARA MARTILLO



• Compatible con 529151, 529161, 529171, 521181 y 521191.

R		A mm	L mm	Ø mm	g	€
529061	10	12	22	8	10	1,39
529071	10	19	28	9	15	1,92
529081	10	22	35	10	20	2,69
529091	10	27	44	13	50	3,71
529101	10	32	55	16	80	5,64

MANGO MADERA PARA MARTILLO



• Mango de madera martillo boca nylon

R			g	€
529751	1	529151	50	1,82
529761	1	529161	70	2,09
529771	1	529171	100	2,32
529781	1	529181	150	2,55
529791	1	529191	170	2,79

1



2



3



4



5



6



7



8



9



10



11



12





FORMONES

JUEGO 3 FORMONES



- Mango mono material de polipropileno
- Acero Cr-V de alta calidad templado a 58±60 HRc
- Hojas rectificadas de precisión con máximo afilado
- Protector en la punta incluido

805-3-C	1	3	12, 18, 25 mm	589	19,99
---------	---	---	---------------	-----	-------

JUEGO 6 GUBIAS PARA TALLA



- Juego de gubias para talla, 6 piezas
- Mango de madera
- Varillas de acero cromo-vanadio de alta calidad
- Dureza hasta 55 HRc para garantizar la durabilidad y el mantenimiento
- Acabado con recubrimiento anti óxido
- Medidas: 160 mm

806-6-B	1	6	160	221	31,29
---------	---	---	-----	-----	-------

	Cinzel cuadrado 12 mm
	Cinzel corte inclinado 12 mm
	Gubia curvada 6,5 mm
	Gubia recta 5 mm
	Gubia curvada 5 mm
	Gubia curvada 12 mm



09. ALICATES - TIJERAS Y CUCHILLOS



ALICATES

ALICATE CORTANTE

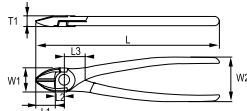

- Acero de alto rendimiento
- Dureza de corte 60-65 HRc
- ISO 5749
- Capacidad de corte:
 - 1- Alambre cobre: 0,50 mm
 - 2- Alambre semi duro: 1,60 mm

€		L	L1	L2	L3	W1	W2	T1	1 mm	2 mm	g	€
624-140-1	5	142	20.5	6	12	18.6	50	10	Ø 0.5 mm	Ø 1.6 mm	170	10,91
624-160-1	5	160	21.5	7	13	21.6	50	11.5	Ø 0.5 mm	Ø 1.6 mm	200	11,67
624-180-1	5	176	24.5	7	14	25.6	50	12.5	Ø 0.5 mm	Ø 1.6 mm	250	12,83

ALICATE CORTANTE REFORZADO

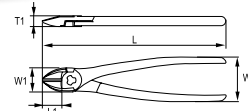

- Acero de alto rendimiento
- Dureza de corte 60-65 HRc
- ISO 5749
- Capacidad de corte:
 - 1- Alambre cobre: 0,50 mm
 - 2- Alambre semi duro: 1,80-2,00 mm

€		L	L1	W1	W2	T1	1 mm	2 mm	g	€
625-180-1	5	180	20.5	25.6	49	11.5	Ø 0.5 mm	Ø 1.8 mm	280	14,19
625-200-1	5	206	23	30	54	12	Ø 0.5 mm	Ø 2.0 mm	320	15,48

ALICATE UNIVERSAL

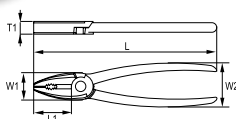

- Acero de alto rendimiento
- Dureza de corte 58-65 HRc
- ISO 5746
- Capacidad de corte:
 - 1- Alambre cobre: 1,00 mm
 - 2- Alambre semi duro: 1,60-2,00-2,50 mm

€		L	L1	W1	W2	T1	1 mm	2 mm	g	€
601-160-1	5	160	35	24	50	10	Ø 1.0 mm	Ø 1.6 mm	190	10,90
601-180-1	5	180	38	27	50	10	Ø 1.0 mm	Ø 2.0 mm	240	11,80
601-200-1	5	197	41.5	29.5	50	10	Ø 1.0 mm	Ø 2.5 mm	300	12,42

ALICATE BOCA SEMIRREDONDA

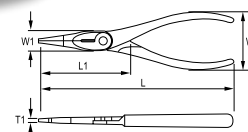

- Acero de alto rendimiento
- Dureza de corte 58-65 HRc
- ISO 5745
- Capacidad de corte:
 - 1- Alambre cobre: 1,00 mm
 - 2- Alambre semi duro: 1,60 mm

€		L	L1	W1	W2	T1	1 mm	2 mm	g	€
612-160-1	5	161	61.5	16.5	49	10	Ø 1.0 mm	Ø 1.6 mm	140	12,99
612-200-1	5	201	78	18	50	10.5	Ø 1.0 mm	Ø 1.6 mm	180	14,76

ALICATE BOCA SEMIRREDONDA CURVA

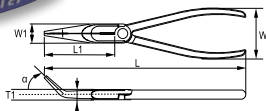

- Acero de alto rendimiento
- Dureza de corte 58-65 HRc
- ISO 5745
- Capacidad de corte:
 - 1- Alambre cobre: 1,00 mm
 - 2- Alambre semi duro: 1,60 mm

€		L	L1	W1	W2	T1	α	1 mm	2 mm	g	€
613-160-1	5	158	48	18	50	9.0	45°	Ø 1.0 mm	Ø 1.6 mm	132	14,29
613-200-1	5	197	74	18	50	10.5	45°	Ø 1.0 mm	Ø 1.6 mm	180	15,36

ALICATE BOCA PLANA

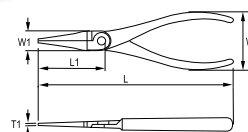

- Acero de alto rendimiento templado a 45-50 HRc
- ISO 5745

€		L	L1	W1	W2	T1	g	€
604-160-1	5	158	48	17	48	9	150	11,56
604-180-1	5	180	50	20	50	11	175	18,74



ALICATE BOCA REDONDA

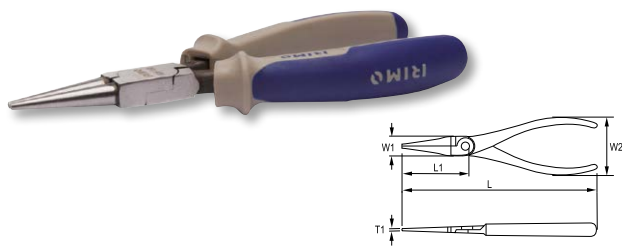

- Acero de alto rendimiento templado a 45-50 HRc
- ISO 5745

Q	📦	L mm	L1 mm	W1 mm	W2 mm	T1 mm	g	€
608-160-1	5	158	38	17	48	8.5	150	11,70

TENACILLA AJUSTE RÁPIDO

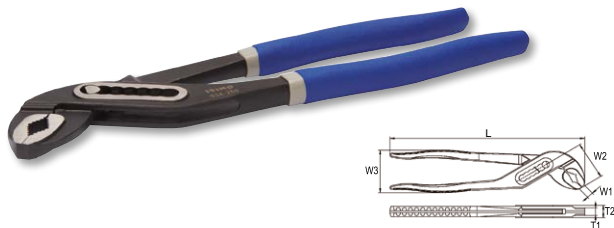

- Acero de alto rendimiento
- Dientes templados a 50-57 HRc
- ISO 8976

Q	📦	L mm	W1 mm	W2 mm	W3 mm	T1 mm	T2 mm	g	€
634-200-1	5	175	5.8	35.8	41	7	12	170	14,39
634-250-1	5	240	5	47.5	50	7.5	12.5	320	14,88
634-300-1	5	302	3	52.5	59.6	8	14.5	430	24,79

TENACILLA AJUSTE RÁPIDO



- Con botón para un ajuste rápido
- Acero de alto rendimiento
- Dientes templados a 50-57 HRc
- ISO 8976

Q	📦	L mm	W1 mm	W2 mm	W3 mm	T1 mm	T2 mm	g	€
634Q-250-1	5	240	5	47.5	50	7.5	12.5	320	21,08

JUEGOS ALICATES

JUEGO ALICATES



- Mangos bi-materiales

Q	📦	📦	📦	g	€
601-3-C	1	3	270 x 205 x 40	690	38,22

601-180-1	
624-160-1	
612-200-1	

JUEGO ALICATES Y TENACILLA



- Mangos bi-materiales

Q	📦	📦	📦	g	€
602-3-C	1	3	270 x 205 x 40	850	38,35

601-180-1	
624-160-1	
634-250-1	

1



2



3



4



5



6



7



8



9



10



11



12





MINI ALICATES

MINI ALICATE UNIVERSAL

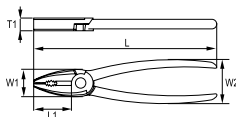

- Mini alicate universal para uso en electrónica y mecánica delicada
- Zonas de agarre para material plano y curvo, adecuado para diferentes usos
- Filo de corte para alambre blando
- Dureza de corte: 58-65 HRc
- Mango bi-material para más comodidad y control
- Con muelle de seguridad
- Material: Aleación de acero de alto rendimiento
- ISO 9655
- Capacidad de corte:
 - 1- Alambre cobre 0,5 mm
 - 2- Alambre semi duro: 0,8 mm

R	Icono	L mm	L1 mm	W1 mm	W2 mm	T1 mm	1 mm	2 mm	g	€
601M-125-1	5	120	22	15	85	7	0.5	0.8	60	11,32

MINI ALICATE BOCA PLANA

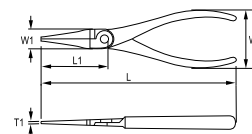

- Mini alicate para trabajos de electrónica y mecánica de precisión
- Bocas finas para sujeción de componentes delicados
- Dureza de corte: 42-50 HRc
- Mango bi-material para más comodidad y control
- Con muelle de seguridad
- Material: Aleación de acero de alto rendimiento
- ISO 9655

R	Icono	L mm	L1 mm	W1 mm	W2 mm	T1 mm	1 mm	2 mm	g	€
604M-125-1	5	130	27	12	85	8			89	11,32

MINI ALICATE BOCA SEMIRREDONDA

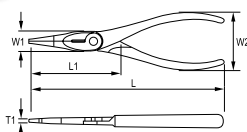

- Mini alicate boca semirredonda para uso en electrónica y mecánica delicada
- Zonas de agarre para material plano y curvo, adecuado para diferentes usos
- Filo de corte para alambre blando
- Dureza de corte: 58-65 HRc
- Mango bi-material para más comodidad y control
- Con muelle de seguridad
- Material: Aleación de acero de alto rendimiento
- ISO 9655
- Capacidad de corte:
 - 1- Alambre cobre 0,5 mm
 - 2- Alambre semi duro: 0,8 mm

R	Icono	L mm	L1 mm	W1 mm	W2 mm	T1 mm	1 mm	2 mm	g	€
612M-125-1	5	130	27	12	85	8	0.5	0.8	86	11,32

MINI ALICATE DE CORTE DIAGONAL

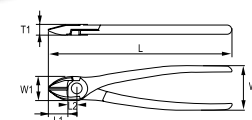

- Mini alicate de corte diagonal para uso en electrónica y mecánica delicada
- Filo de corte endurecido por inducción para alambre blando y duro
- Cabeza ovalada
- Dureza de corte: 58-65 HRc
- Mango bi-material para más comodidad y control
- Con muelle de seguridad
- Material: Aleación de acero de alto rendimiento
- ISO 9654
- Capacidad de corte:
 - 1- Alambre cobre 0,5 mm
 - 2- Alambre semi duro: 0,8 mm

R	Icono	L mm	L1 mm	W1 mm	W2 mm	T1 mm	1 mm	2 mm	g	€
624M-125-1	5	120	16	12	85	8	0.5	0.8	81	11,32



MINI ALICATE DE CORTE FRONTAL

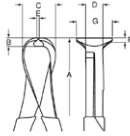

- Mini alicate de corte frontal para uso en electrónica y mecánica delicada
- Filo de corte endurecido por inducción para alambre blando y duro
- Dureza de corte: 58-65 HRc
- Mango bi-material para más comodidad y control
- Con muelle de seguridad
- Material: Aleación de acero de alto rendimiento
- ISO 9654
- Capacidad de corte:
 - 1- Alambre cobre 0,5 mm
 - 2- Alambre semi duro: 0,8 mm

R	A	B	C	D	E	F	G	1 mm	2 mm	g	€	
626M-125-1	5	110	8	16	10	3	3	9	0.5	0.8	81	11,32

ALICATES PARA ELECTRICISTA

ALICATE PELACABLES

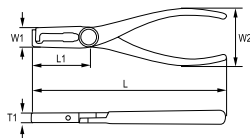

- Acero de alto rendimiento
- Templado a 45-50 HRc

R	L	L1	W1	W2	T1	+	g	€	
629-160-1	5	160	40.5	19	48	9	1-6	170	15,61

ALICATE CORTANTE PARA COBRE Y ALUMINIO

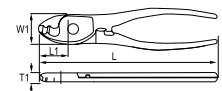

- Alicates para cortar y pelar cables de cobre y aluminio
- Acabado: Las superficies forjadas tienen un acabado fosfatado y pulido
- Material: Acero al carbono, mangos recubiertos de PVC

R	L	L1	W1	T1	+	g	€		
655-160-1	5	160	25	25	10	50/35	10	160	22,47
655-200-1	5	200	28	30	12	70/50	13	280	27,57

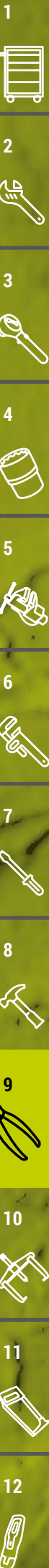



ALICATES PARA ELECTRICISTA

ALICATE PARA TERMINALES AISLADOS

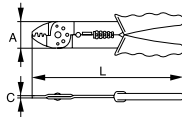
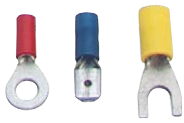

- Alicates para cortar, pelar y engastar terminales aislados
- Fabricados en acero templado
- Prensa terminales: 1,5/2,5/6 mm²
- Corta cables: M2.6-M5.0
- Capacidad de pelado: 0,75-6,0 mm²

€	📦	L	A	C	🔗	🔗	✂️	✂️	✂️	📦	€
		mm	mm	mm	mm ²	AWG	mm ²	AWG	mm ²	g	
630-B1-1	12	220	38	3	1.5-6.0	20-10	0.75-6.0	20-10	0.75-6.00	220	11,27

ALICATE PARA TERMINALES NO AISLADOS

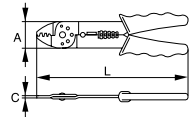

- Alicates para cortar, pelar y engastar terminales no aislados
- Fabricados en acero templado
- Prensa terminales: 1,5/2,5/6 mm²
- Corta cables: M2.6-M5.0
- Capacidad de pelado: 0,75-6,0 mm²

€	📦	L	A	C	🔗	🔗	✂️	✂️	✂️	📦	€
		mm	mm	mm	mm ²	AWG	mm ²	AWG	mm ²	g	
630-B2-1	12	220	38	3	1.5-6.0	14-10	0.75-6.0	18-12	0.75-6.00	220	11,27

ALICATE PARA TERMINALES NO AISLADOS TIPO FASTON

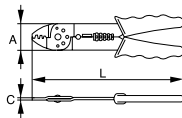

- Alicates para cortar, pelar y engastar terminales no aislados Tipo Faston
- Fabricados en acero templado
- Prensa terminales: 1,5/2,5/6 mm²
- Corta cables: M2.6-M5.0
- Capacidad de pelado: 0,75-6,0 mm²

€	📦	L	A	C	🔗	🔗	✂️	✂️	✂️	📦	€
		mm	mm	mm	mm ²	AWG	mm ²	AWG	mm ²	g	
630-B3-1	12	220	38	3	1.5-6.0	14-10	0.75-6.0	18-12	0.75-6.00	220	11,27

JUEGO DE ALICATE PARA TERMINALES AISLADOS CON 60 TERMINALES



- Juego con alicate para cortar, pelar y engastar terminales aislados y 60 terminales aislados
- Fabricados en acero templado
- Prensa terminales: 1,5/2,5/6 mm²
- Corta cables: M2.6-M5.0
- Capacidad de pelado: 0,75-6,0 mm²

€	📦	📦	📦	📦	📦	€
630-61B1-4	1	60 + 1	24 x 160 x 270	370	21,35	



JUEGO DE TERMINALES AISLADOS Y CONECTORES DE ENCHUFE, 295 piezas



- Caja de plástico con compartimentos
- Contenido:
 - 45 piezas de manguitos terminales aislados con diferentes diámetros
 - 250 piezas de conectores macho aislados con diferentes formas y diámetros

Artículo	Caja	Piezas	Dimensiones	Peso	Precio
630-295T-4	1	295	30 x 115 x 220	250	27,11

JUEGO DE ALICATES PARA ENGASTAR CON MORDAZAS INTERCAMBIABLES



* Compatible para conector placa solar MC 4

- Caja moldeada por soplado
- Alicata de carraca resistente con mangos bimeriales para un agarre perfecto
- Contenido:
 - Mordaza para terminales de barril abierto no aislados 0,5-6 mm² / AWG 22-10
 - Mordazas para terminales aislados 0,5-6 mm² / AWG 22-10
 - Mordaza para terminales de cable doble sin aislamiento 6-16 mm² / AWG 10-6
 - Mordaza para terminales de cable 4-35 mm² / AWG 10-35
 - Mordaza para terminales no aislados 0,5-10 mm² / AWG 22-8

Artículo	Caja	Mordazas	Dimensiones	Peso	Precio
630-5HD-4	1	5	60 x 250 x 290	450	94,19

ALICATES SEGURIDAD

ALICATE UNIVERSAL AISLADO

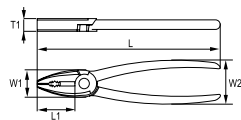

- Para trabajos en baja tensión hasta 1000 V
- Acero de alto rendimiento
- Dureza de corte 58-65 HRc
- ISO 5746
- Capacidad de corte:
 - 1- Alambre cobre: 1,00 mm
 - 2- Alambre semi duro: 1,60-2,00-2,50 mm

Artículo	Caja	L	L1	W1	W2	T1	Ø 1 mm	Ø 2 mm	Peso	Precio
601V-160-1	5	160	35	24	50	10	Ø 1.0 mm	Ø 1.6 mm	190	18,86
601V-180-1	5	180	38	27	50	10	Ø 1.0 mm	Ø 2.0 mm	240	21,01
601V-200-1	5	197	41.5	29.5	50	11	Ø 1.0 mm	Ø 2.5 mm	300	23,23

ALICATE BOCA PLANA AISLADO

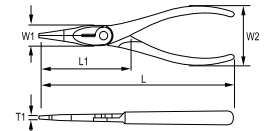

- Para trabajos en baja tensión hasta 1000 V
- Acero de alto rendimiento
- Dureza de corte 58-65 HRc
- ISO 5745

Artículo	Caja	L	L1	W1	W2	T1	Peso	Precio
604V-160-1	5	158	48	17	50	9	150	23,41



ALICATES SEGURIDAD

ALICATE BOCA SEMIRREDONDA AISLADO

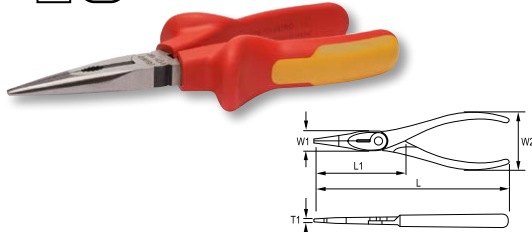
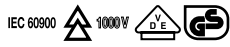

- Para trabajos en baja tensión hasta 1000 V
- Dureza de corte 58-65 HRc
- ISO 5746
- Capacidad de corte:
 - 1- Alambre cobre: 1,00 mm
 - 2- Alambre semi duro: 1,60 mm

Q	W	L	L1	W1	W2	T1	Ø	Ø	g	€
		mm	mm	mm	mm	mm	1 mm	2 mm		
612V-160-1	5	161	61.5	16.5	49	10	Ø 1.0 mm	Ø 1.6 mm	140	19,98
612V-200-1	5	201	78	18	50	10.5	Ø 1.0 mm	Ø 1.6 mm	180	22,77

ALICATE BOCA SEMIRREDONDA CURVA AISLADO

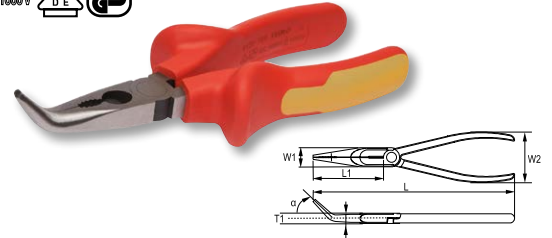

- Para trabajos en baja tensión hasta 1000 V
- Acero de alto rendimiento
- Dureza de corte 58-65 HRc
- ISO 5745
- Capacidad de corte:
 - 1- Alambre cobre: 1,00 mm
 - 2- Alambre semi duro: 1,60 mm

Q	W	L	L1	W1	W2	T1	α	Ø	Ø	g	€
		mm	mm	mm	mm	mm		1 mm	2 mm		
613V-160-1	5	158	50	18	18	9.0	45°	Ø 1.0 mm	Ø 1.6 mm	132	21,05
613V-200-1	5	197	74	18	50	10.5	45°	Ø 1.0 mm	Ø 1.6 mm	180	24,63

ALICATE CORTANTE AISLADO

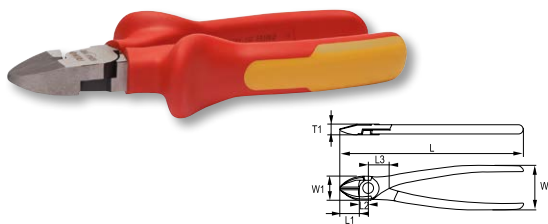

- Para trabajos en baja tensión hasta 1000 V
- Acero de alto rendimiento
- Dureza de corte 60-65 HRc
- ISO 5749
- Capacidad de corte:
 - 1- Alambre cobre: 0,50 mm
 - 2- Alambre semi duro: 1,60 mm

Q	W	L	L1	L2	L3	W1	W2	T1	Ø	Ø	g	€
		mm	mm	mm	mm	mm	mm	mm	0.5 mm	1.6 mm		
624V-140-1	5	142	20.5	7	13	18.6	50	10.0	Ø 0.5 mm	Ø 1.6 mm	170	17,25
624V-160-1	5	155	21.5	7	13	21.6	50	11.5	Ø 0.5 mm	Ø 1.6 mm	200	19,33

ALICATE CORTANTE REFORZADO AISLADO

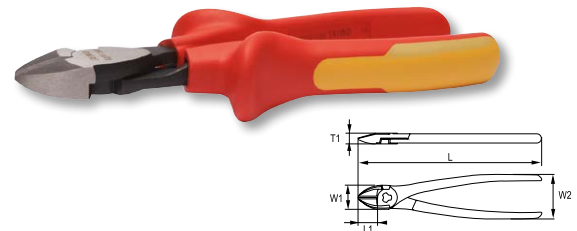

- Para trabajos en baja tensión hasta 1000 V
- Acero de alto rendimiento
- Dureza de corte 60-65 HRc
- ISO 5749
- Capacidad de corte:
 - 1- Alambre cobre: 0,50 mm
 - 2- Alambre semi duro: 1,80 mm

Q	W	L	L1	W1	W2	T1	Ø	Ø	g	€
		mm	mm	mm	mm	mm	1 mm	2 mm		
625V-180-1	5	180	20.5	25.6	49	11.5	Ø 0.5 mm	Ø 1.8 mm	280	21,65



ALICATE PELACABLES AISLADO

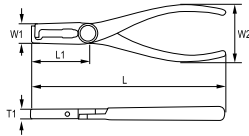

- Para trabajos en baja tensión hasta 1000 V
- Acero de alto rendimiento
- 45-50 HRc

629V-160-1	5	L mm	L1 mm	W1 mm	W2 mm	T1 mm	± mm	g	€
629V-160-1	5	160	40.5	19	48	9	1-6	170	25,37

TENACILLA AISLADA

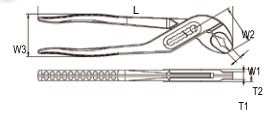

- Para trabajos en baja tensión hasta 1000 V
- Acero de alto rendimiento
- Dientes templados a 50-57 HRc
- ISO 8976

634V-250-1	5	L mm	W1 mm	W2 mm	W3 mm	T1 mm	T2 mm	g	€
634V-250-1	5	240	5	47.5	50	7.5	12.5	310	27,28

JUEGOS ALICATES SEGURIDAD

JUEGO DE ALICATES AISLADOS



- Para trabajos en baja tensión hasta 1000 V
- Acero de alto rendimiento
- IEC 60900

601V-3-C	1	3	270 x 205 x 40	690	63,10
624V-160-1				601V-180-1	
612V-200-1					

TENAZAS

TENAZA DE CARPINTERO

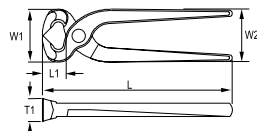

- Dureza de corte 58-64 HRc
- ISO 9243
- Capacidad de corte: Alambre semi duro: 1,60 mm

631-200-1	5	L mm	L1 mm	W1 mm	W2 mm	T1 mm	± mm	g	€
631-200-1	5	200	23	53	45	24	1.6 mm	360	12,85

TENAZA DE ENCOFRADOR

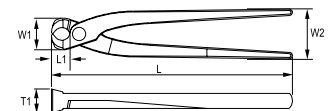

- Dureza de corte 58-64 HRc
- ISO 9242
- Capacidad de corte: Alambre semi duro: 1,60 mm

632-220-1	5	L mm	L1 mm	W1 mm	W2 mm	T1 mm	± mm	g	€
632-220-1	5	220	16	29.4	46	22	1.6 mm	350	11,64
632-250-1	5	250	18	33	46	24.5	1.6 mm	400	13,07
632-280-1	5	280	19	37	48	24.5	1.6 mm	460	15,44

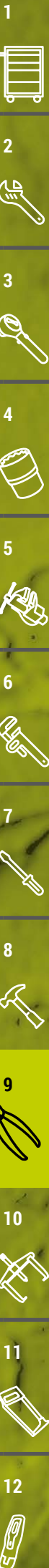



TENAZAS

TENAZA DE ENCOFRADOR CON MANGOS PVC

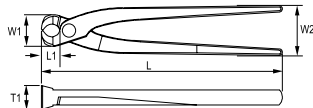

- Mangos recubiertos de PVC azul
- Dureza: dientes endurecidos a 58-68 HRc
- ISO 9242
- Capacidad de corte: 1,60 mm

R	Icono	L mm	L1 mm	W1 mm	W2 mm	T1 mm	Icono	g	€
632D-250-1	5	250	18	33	46	24.5	1.6 mm	400	15,32

CORTAVARILLAS

CORTAVARILLAS

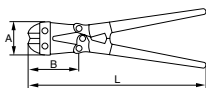

- Acero de alta resistencia
- Cuchillas con doble tratamiento térmico
- Acabado pavonado

R	Icono	L mm	A mm	B mm	Ø 80 kg/mm ²	Ø 160 kg/mm ²	Ø 120 kg/mm ²	g	€
651101	1 N.0	320	48	77	5	4	3	500	50,07
651111	1 N.1	470	66	104	7	6	5	1.785	80,12
651121	1 N.2	630	85	137	9	8	7	2.860	96,33
651131	1 N.3	750	100	160	11	9	8	4.410	126,44
651141	1 N.4	900	120	182	13	10	9	5.800	164,40

CABEZA DE REPUESTO PARA CORTAVARILLAS



R	+ M8	+ M10-12	Icono	A mm	B mm	g	€
651201N	651201N2	1	651101	48	77	180	36,08
651211N	651211N2	1	651111	66	104	370	42,99
651221N	651221N2	1	651121	85	137	875	51,69
651231N	651231N2	1	651131	100	160	1.295	67,87
651241N	651241N2	1	651141	120	182	1.930	87,58



ALICATES PARA ANILLOS O ARANDELAS

ALICATE RECTO PARA ANILLOS INTERIORES



- Acabado pavon para protección contra la corrosión
- Acero aleado de alto rendimiento
- Dureza 45-50 HRc
- Puntas forjadas rectas
- DIN 5256

E	Paquete	L mm	B mm	E mm	Alcance	Material	g	€
621551	5	140	38	0.8	8 - 13	1	80	17,41
621561	5	140	38	1.2	12 - 25	1	80	17,41
621571	5	180	57	1.7	19 - 60	1	170	19,88
621581	5	225	69	2.2	40 - 100	1	275	24,70
621591	1	310	95	3.1	85 - 165	1	490	32,81

ALICATE CURVO PARA ANILLOS INTERIORES



- Acabado pavon para protección contra la corrosión
- Acero aleado de alto rendimiento
- Dureza 45-50 HRc
- Puntas forjadas curvadas
- DIN 5256

E	Paquete	L mm	B mm	E mm	Alcance	Material	g	€
621651	5	127	25	0,8	8 - 13	1	80	17,64
621661	5	127	25	1,2	12 - 25	1	80	17,64
621671	5	165	43	1,7	19 - 60	1	170	20,35
621681	5	208	52	2,2	40 - 100	1	275	25,76
621691	1	289	74	3,1	85 - 165	1	490	36,22

ALICATE RECTO PARA ANILLOS EXTERIORES



- Acabado pavon para protección contra la corrosión
- Acero aleado de alto rendimiento
- Dureza 45-50 HRc
- Puntas forjadas rectas
- Muelle interno
- DIN 5254

E	Paquete	L mm	B mm	E mm	Alcance	Material	g	€
621751	5	140	38	0.8	3 - 10	1	80	18,24
621761	5	140	38	1.2	10 - 25	1	80	18,24
621771	5	180	57	1.7	19 - 60	1	170	20,23
621781	5	225	69	2.2	40 - 100	1	275	24,58
621791	1	295	95	3.1	85 - 165	1	490	36,45

ALICATE CURVO PARA ANILLOS EXTERIORES

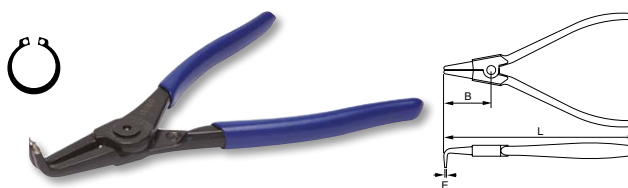

- Acabado pavon para protección contra la corrosión
- Acero aleado de alto rendimiento
- Dureza 45-50 HRc
- Puntas forjadas curvadas
- Muelle interno
- DIN 5254

E	Paquete	L mm	B mm	E mm	Alcance	Material	g	€
621851	5	127	25	0.8	3 - 10	1	80	18,47
621861	5	127	25	1.2	10 - 25	1	80	18,47
621871	5	165	43	1.7	19 - 60	1	170	20,93
621881	5	208	52	2.2	40 - 100	1	275	25,76
621891	1	295	74	3.1	85 - 165	1	490	36,45

JUEGO DE ALICATES



- Acabado pavon para protección contra la corrosión
- Acero aleado de alto rendimiento
- Dureza 45-50 HRc
- Puntas forjadas
- DIN 5254

E	Paquete	X	Paquete	g	€
601911	1	4	260 x 220 x 30	750	93,57
621571			621671		
621771			621871		





TIJERAS CORTACHAPAS

CORTE RECTO



- Mandíbulas de acero cromo molibdeno forjadas para mayor resistencia
- Filos fresados con precisión
- Suave acción de corte y gran poder de agarre. Sistema palanca
- Mangos con doble inyección con zona antideslizante y muelle de retorno que mejora en confort
- Capacidad de corte: 1- Acero inox, 2- Acero laminado en frío

€	Paquete	L mm	1 mm	2 mm	g	€
658-250-1	1	250	0.7	1.2	390	21,98

CORTE DERECHA



- Mandíbulas de acero cromo molibdeno forjadas para mayor resistencia
- Filos fresados con precisión
- Suave acción de corte y gran poder de agarre. Sistema palanca
- Mangos con doble inyección con zona antideslizante y muelle de retorno que mejora en confort
- Capacidad de corte: 1- Acero inox, 2- Acero laminado en frío

€	Paquete	L mm	1 mm	2 mm	g	€
659-250-1	1	250	0.7	1.2	395	21,98

CORTE IZQUIERDA



- Mandíbulas de acero cromo molibdeno forjadas para mayor resistencia
- Filos fresados con precisión
- Suave acción de corte y gran poder de agarre. Sistema palanca
- Mangos con doble inyección con zona antideslizante y muelle de retorno que mejora en confort
- Capacidad de corte: 1- Acero inox, 2- Acero laminado en frío

€	Paquete	L mm	1 mm	2 mm	g	€
660-250-1	1	250	0.7	1.2	405	21,98

GRIPS

MORDAZA UNIVERSAL, BOCAS CURVAS CON CORTANTE

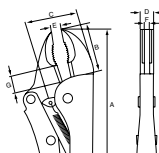

- Uso general, sujeción de barras, chapas, tuercas y tornillos
- Bocas fuertes, forjadas
- Acero de cromo molibdeno
- Niquelado

€	Paquete	A mm	B mm	C mm	D mm	E mm	F mm	G mm	F _{Fe+} mm	g	€	
64A-190-1	1	190	31	40	12	0-20	7	5	2	338	358	21,74
64A-235-1	1	225	38	48	12	0-35	7	6	3	543	556	24,80

MORDAZA UNIVERSAL, BOCAS RECTAS

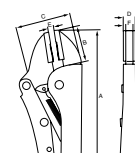

- Para chapas metálicas, barras pequeñas y piezas finas
- Bocas fuertes, reforzadas. Forjadas
- Acero de cromo molibdeno
- Niquelado

€	Paquete	A mm	B mm	C mm	D mm	E mm	F mm	g	€
64B-190-1	1	190	29	42	15	0-17	13	358	22,13
64B-235-1	1	225	32	54	17	0-21	13	556	24,80



MORDAZA GRIP DE BOCA LARGA



- Bocas de largo alcance, forjadas
- Las bocas tienen forma de sujeción recta y curva
- Acero de cromo molibdeno
- Niquelado

Q	Icono	A mm	B mm	C mm	D mm	E mm	F mm	g	€
64L-165-1	1	165	52	25	9	6	0-18	195	16,78

MORDAZA PARA SOLDADURA TIPO "U"



- La forma en U permite una buena visión y acceso en trabajos de soldadura
- Forma de horquilla para incrementar la fuerza
- Acero de cromo molibdeno
- Niquelado

Q	Icono	A mm	B mm	C mm	D mm	E mm	F mm	g	€
64W-300-1	1	263	75	70	75	70	44	832	33,56

MORDAZA DE ACERO CON SUJECIÓN C



- Forma de C para sujetar piezas voluminosas
- Acero cromo vanadio
- Niquelado

Q	Icono	A mm	B mm	C mm	D mm	E mm	F mm	g	€
64C-300-1	1	275	90	140	14	0-65	7	775	34,27

MORDAZA DE ACERO, BOCAS OSCILANTES



- Forma de C para sujetar piezas voluminosas
- Oscilante, para sujetar piezas no paralelas e irregulares
- Acero cromo vanadio
- Niquelado

Q	Icono	A mm	B mm	C mm	D mm	E mm	F mm	g	€
64CA-175-1	1	175	61	90	21	0-32	5	276	24,26
64CA-300-1	1	280	95	130	28	0-72	7	835	32,00
64CA-450-1	1	460	270	150	28	0-130	7	1280	54,04

MORDAZA DE ACERO, OSCILANTE, FINA



- Largo alcance
- Oscilante, para sujetar piezas no paralelas e irregulares
- Acero de cromo molibdeno
- Niquelado

Q	Icono	A mm	B mm	C mm	D mm	E mm	F mm	g	€
64CAD-300-1	1	282	97	81	28	0-72	7	850	31,90

MORDAZA PLANA EN C



- Oscilante, para sujetar piezas no paralelas e irregulares
- Palanca oculta para evitar el desbloqueo no deseado
- Acero de cromo molibdeno
- Niquelado

Q	Icono	A mm	B mm	C mm	D mm	Ø mm	g	€
64T-300-1	1	300	0-80	95	90	12.4	650	49,99





GRIPS

MORDAZA GRIP DE CUATRO POSICIONES

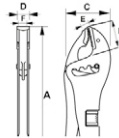

- Cromado plateado para protección contra la oxidación
- Con mordazas planas y convexas que pueden ajustarse en 4 posiciones diferentes para una mayor capacidad de agarre
- Agarra la mayoría de perfiles L,T y U

€	📦	A mm	B mm	C mm	D mm	E mm	F mm	g	€
647-235-1	1	235	37	59	17	10	15	540	47,41

MORDAZA GRIP DE CUATRO POSICIONES

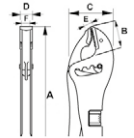

- Cromado plateado para protección contra la oxidación
- Con mordazas planas y convexas que pueden ajustarse en 4 posiciones diferentes para una mayor capacidad de agarre
- Mordazas extra largas con doble capacidad de agarre comparado con una mordaza estándar
- Agarra la mayoría de perfiles L,T y U

€	📦	A mm	B mm	C mm	D mm	E mm	F mm	g	€
647-250-1	1	255	67	64	17	10	15	650	52,72

MORDAZA GRIP DE BOCAS CURVAS Y CORTANTE

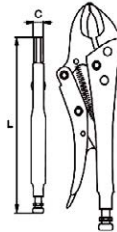

- Acero al cromo vanadio. Cromado
- Forma: bocas curvadas para usos generales
- Mango bi-material de agarre suave

€	📦	L mm	C mm	🔪 mm	g	€
648-140-1	1	140	7	28	160	15,65
648-185-1	1	185	8.5	41	345	16,27
648-250-1	1	225	10.5	48	525	17,21

MORDAZA GRIP DE NARIZ LARGA

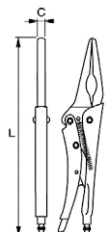

- Acero al cromo vanadio. Cromado
- Forma: diseño de la nariz larga y estrecha
- Mango bi-material de agarre suave

€	📦	L mm	C mm	🔪 mm	g	€
648-165-1	1	165	4.2	57	180	15,97

JUEGO DE MORDAZAS GRIP



- Mango bi-material de agarre suave
- Bolsa nylon enrollable

€	📦	📦	g	€
648-4-W	1	4	1.200	57,09

648-140-1, 648-185-1, 648-250-1

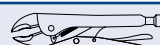

648-165-1



TENAZAS DE AJUSTE RÁPIDO

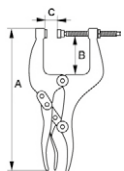

- Pavonadas
- Grapa de bloqueo con mordaza móvil para incrementar flexibilidad y el trabajo en general
- Uso en bancos de trabajo, fábricas de producción, trabajos de mantenimiento en general

€	📦	A mm	B mm	C mm	🔩	🔩	🔩	g	€
645011	1	193	30	32	645-L075	645-YOKE	645-NUT	690	56,13
645021	1	196	30	70	645-L120	645-YOKE	645-NUT	765	59,70
645031	1	240	62	70	645-L120	645-YOKE	645-NUT	935	62,57
645041	1	240	62	150	645-L200	645-YOKE	645-NUT	1.180	77,36



REMACHADORA

REMACHADORA MANUAL



- Remachadora de cuatro boquillas intercambiables para medidas de remachado: 1,8-2,2-2,8-3,2 mm
- Para uso en aluminio, acero, acero inoxidable y cobre
- Incluye una llave para cambio de boquillas

€		L mm	A mm	B mm	g	€
546-265-1	1	265	90	25	700	54,94



Repuestos para remachadora 546-265-1			€
546-265-A	Juego componentes de las mordazas	1	15,17
546-265-B	Juego 4 boquillas	1	9,29

REMACHADORA DE TUERCAS



- Suministrado con boquillas y madrilos métrica M3, M4, M5 y M6
- Para tuercas de aluminio, acero y acero inoxidable

€		L mm	A mm	B mm	g	€
548-275-1	1	270	100	23	700	98,19



Repuestos para remachadora 548-275-1			€
548-275-M3	Boquilla y madrino M3	1	4,77
548-275-M4	Boquilla y madrino M4	1	4,77
548-275-M5	Boquilla y madrino M5	1	4,77
548-275-M6	Boquilla y madrino M6	1	4,77

REMACHADORA 2 BRAZOS



- Remachadora de dos manos para mayor efecto palanca
- Para remaches de aluminio, acero e inox con capacidad de remachado de 3,2; 4,0; 4,8; 6,0 y 6,8 mm
- El tubo transparente recoge los ribetes

€		A mm	B mm	C mm	D mm	g	€
546021	1	520	22	58	160	1.800	182,77



Repuestos para remachadora 546021		€
546201	Boquilla Ø 4 mm	5,12
546211	Boquilla Ø 5 mm	5,12
546221	Boquilla Ø 6-6,4 mm	5,12
546251	Juego 3 mordazas	18,97
1467-A01	Tubo transparente	28,24

JUEGO DE REMACHADORA MANUAL



- 265 mm remachadora de uso general con cuatro cabezas intercambiables diferentes
- Para remaches de 2,4 mm; 3,0 a 3,2 mm; 4,0 mm y 4,8 mm
- Incluye una llave para cambiar las cabezas
- Para utilizar con aluminio, acero, acero inoxidable y remaches de cobre
- 160 remaches (40 de cada tamaño)
- Estuche de plástico

€				g	€
546-265-4	1	160	300 x 210 x 60	1.200	56,68





TIJERAS Y NAVAJAS DE ELECTRICISTA

CUTTER CUCHILLA SECCIONABLE, 9 MM

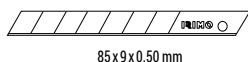

Artículo	Paquetes	Longitud (mm)	Peso (g)	Precio (€)
667-135-1	12	133	56	4,02

CUTTER CUCHILLA SECCIONABLE, 18 MM

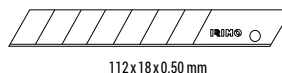

Artículo	Paquetes	Longitud (mm)	Peso (g)	Precio (€)
666-156-1	12	157	106	6,78

CUTTER DE SEGURIDAD, 18 MM



- Hoja autorretráctil para mayor seguridad

Artículo	Paquetes	Longitud (mm)	Peso (g)	Precio (€)
668-150-1	12	150	157	5,09

CUCHILLO DE SEGURIDAD



- Cuchillo de seguridad
- Hoja retráctil

Artículo	Paquetes	Longitud (mm)	Peso (g)	Precio (€)
669-175-1	10	175	210	7,54

RASQUETA PARA VIDRIO CON CUCHILLAS INTERCAMBIABLES

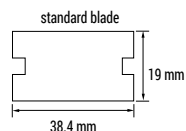

- Ideal para eliminar pintura, pegamento, pegatinas o masilla de cristales, azulejos, paredes, suelos y otras superficies suaves
- Diseño ergonómico en dos materiales
- Sistema de retracción de la cuchilla para un almacenamiento seguro
- Compartimento con 5 cuchillas incluidas
- Medida adaptada a la palma de la mano, 130 mm
- Hojas estándar de 40 mm

Artículo	Paquetes	Longitud (mm)	Peso (g)	Precio (€)
538-140-1	1	135	65	5,57



CUCHILLOS MULTIUSOS CON FUNDA



- Cómodo mango que proporciona un agarre excelente
- Se suministra con una funda que se puede llevar en el cinturón
- Robusto cuchillo multiusos con sólida hoja de acero inoxidable

R	Icono	A mm	L mm	g	€
672-220-1	12	100	220	233	8,40

CUCHILLO PLEGABLE



- Hoja de acero inoxidable 3Cr13
- Mango de acero inoxidable 106 mm
- Ligero y cómodo
- Incluye gancho para cinturón
- Longitud total: 178 mm
- Grosor de la hoja: 2,3 mm

R	Icono	A mm	L mm	g	€
670-178-1	10	78	178	120	14,87

CUCHILLO PLEGABLE



- Hoja de acero inoxidable 3Cr13
- Mango negro 113 mm
- Ligero y cómodo
- Incluye gancho para cinturón
- Longitud total: 190 mm
- Grosor de la hoja: 2,6 mm

R	Icono	A mm	L mm	g	€
669-190-1	10	77	190	130	17,35

CUCHILLO DE ELECTRICISTA



- Navaja de bolsillo para electricista con función pelacables, mango de madera

R	Icono	A mm	L mm	g	€
664-200-1	10	85	200	83	13,28

CUCHILLO DE ELECTRICISTA



- Navaja de bolsillo para electricista de acero inoxidable con función pelacables, mango de plástico

R	Icono	A mm	L mm	g	€
665-200-1	10	85	200	60	12,03

MULTIHERRAMIENTAS



- Multiherramienta plegable de acero inoxidable 3Cr13
- Longitud: 96 mm cerrada / 150 mm en total
- Estuche incluido para fácil transporte
- Incluye:
 - Tenaza
 - Alicata universal
 - Corta cables
 - Cuchillo
 - 5 Destornilladores planos
 - Abre latas
 - Sierra
 - Lima para madera y metal
 - Abre botellas
 - Tijeras
 - Destornillador Phillips

R	Icono	L mm	g	€
671-150-1	10	150 (96)	255	28,50





TIJERAS Y NAVAJAS DE ELECTRICISTA

TIJERAS DE ELECTRICISTA



- Tijeras de electricista con plástico protector para los dedos
- Curvatura en la hoja para pelar cables de hasta 43 mm

€		A mm	L mm	g	€
661051	10	42.5	130	70	10,12

TIJERAS DE ELECTRICISTA



- Tijeras de electricista reforzada con plástico protector para los dedos
- Curvatura en la hoja para pelar cables con mayor accesibilidad
- Capacidad de corte 38 mm
- Menor esfuerzo de corte

€		A mm	L mm	g	€
661061	10	38	152	130	15,61

TIJERAS DE ELECTRICISTA



- Cuerpo de acero que cubre toda la tijera
- Hoja micro dentada
- Mangos recubiertos de PVC
- Longitud corte 43 mm
- Funda de plástico con colgador giratorio

€		A mm	L mm	g	€
661-140-1	12	43	145	76	20,68



- Caja expositora 12 tijeras electricista

€		€
661-140-12-DISP	1	235,19

GANCHOS

JUEGO 4 GANCHOS, BI-COMPONENTE

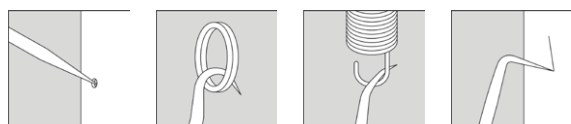

- Para rascar, manipular o quitar anillos, muelles, soldaduras, etc.
- Largura: 170 mm
- Mango ligero bi-componente
- Material: Varillas de acero al carbono, puntas endurecidas 40 HRC
- Composición:
 - 1 Pico recto,
 - 1 gancho angulado 45°,
 - 1 gancho 90° y
 - 1 gancho completo

€				g	€
722-4-1	12	4	20 x 230 x 130	100	11,16



10. HERRAMIENTAS DE EXTRACCIÓN



EXTRACTORES

EXTRACTOR UNIVERSAL DE 2 BRAZOS

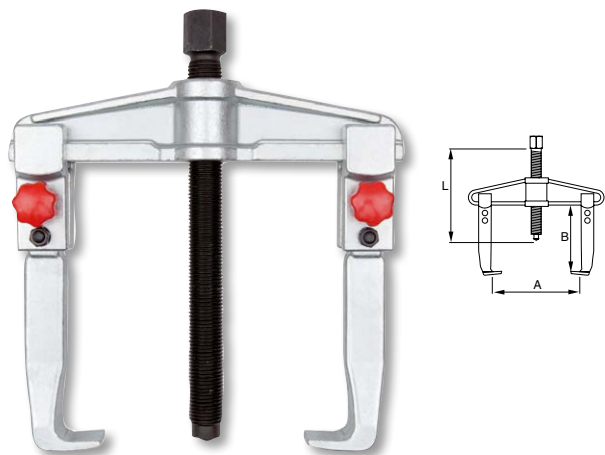

- Cuerpo y brazos fabricados en acero forjado
- Perfil con forma de viga, ligero y resistente
- Acabado galvanizado, con husillo templado por inducción
- Brazos forjados cromo-vanadio, máxima resistencia
- Girando los brazos, el extractor puede ser utilizado como externo o interno
- Uñas diseñadas para permitir el acceso a lugares estrechos
- Tuercas en PVC para un ajuste rápido y sencillo

Q	Q	A mm	B mm	L mm	T _h	g	€
701-90-1	N1	1	90	100	130	4	900 70,42
701-130-1	N11	1	130	100	130	4	980 73,57
701-160-1	N2	1	160	150	210	6	2.450 121,91
701-200-1	N21	1	200	150	210	6	2.880 126,10
701-250-1	N3	1	250	205	280	8	6.950 211,06
701-350-1	N31	1	350	205	280	8	7.680 249,84



Q	Q	mm	mm	g	€	Q	L mm	g	€	Q	L mm	g	€
701-90-1	701-90-S	17	M14x1.5x130	175	7,51	701-90-K	95	528	22,57	701-90-B	136	315	17,51
701-130-1	701-90-S	17	M14x1.5x130	175	7,51	701-90-K	95	528	22,57	701-130-B	177	485	19,09
701-160-1	701-160-S	22	M20x2x210	575	14,64	701-160-K	150	1.058	43,90	701-160-B	217.5	890	34,15
701-200-1	701-160-S	22	M20x2x210	575	14,64	701-160-K	150	1.058	43,90	701-200-B	262	1.360	39,99
701-250-1	701-250-S	27	M27x2x280	1.275	37,95	701-250-K	202	3.262	113,74	701-250-B	330	2.750	88,44
701-350-1	701-250-S	27	M27x2x280	1.275	37,95	701-250-K	202	3.262	113,74	701-350-B	430	3.575	124,51

EXTRACTOR DOS GARRAS AUTOCENTRANTE

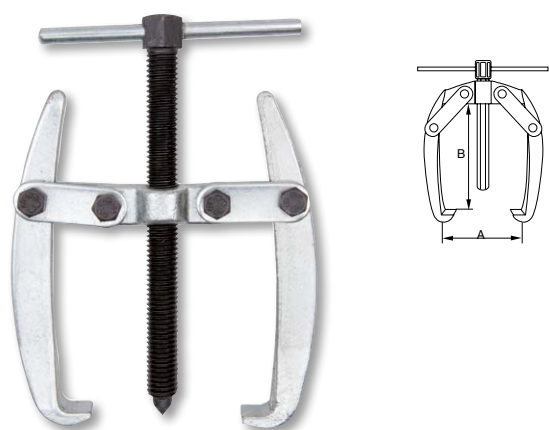

- Cuerpo y brazos de acero forjado
- Acabado galvanizado
- Ideal para extraer pequeñas partes como terminales de baterías, ruedas, rodamientos, etc.
- Los extremos de las garras se cierran automáticamente

Q	Q	A mm	B mm	T _h	g	€
702-40-1	1	60	40	0.50	180	23,06
702-65-1	1	65	65	0.50	190	24,84
702-80-1	1	80	80	1.00	220	43,27



Q	Q	mm	g	€	Q	L mm	g	€	Q	L mm	g	€	Q	L mm	g	€
702-40-1	702-40-S	M10x1.5x100	61	1,34	702-40-K	54.5	40	4,07								
702-65-1	702-65-S	M10x1.5x105	63	1,70	702-65-K	88	74	4,99	702-40-B	42x13	20	4,03	702-40-P	33.5x3	20	0,48
702-80-1	702-80-S	M10x1.5x122	72	2,20	702-80-K	103	98	6,59								



EXTRACTOR DE TRES GARRAS AUTOCENTRANTE

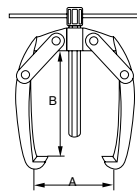

- Cuerpo y brazos de acero forjado
- Acabado galvanizado
- Ideal para extraer pequeñas partes como terminales de baterías, ruedas, rodamientos, etc.
- Los extremos de las garras se cierran automáticamente

Q	Q	A mm	B mm	$\frac{1000}{T_n}$	g	€
703-40-1	1	60	40	0,75	230	31,90
703-65-1	1	65	65	0,75	290	34,50
703-80-1	1	80	80	1,50	320	53,72



Q	Q	L mm	g	€	Q	L mm	g	€	Q	L mm	g	€	Q	L mm	g	€				
703-40-1	702-40-S	M10x1.5x100	61	1,34	702-40-K	54.5	40	4,07					702-40-B	42x13	20	4,02	702-40-P	33.5x3	20	0,48
703-65-1	702-65-S	M10x1.5x105	63	1,70	702-65-K	88	74	4,99												
703-80-1	702-80-S	M10x1.5x122	72	2,20	702-80-K	103	98	6,59												

EXTRACTOR MÚLTIPLE

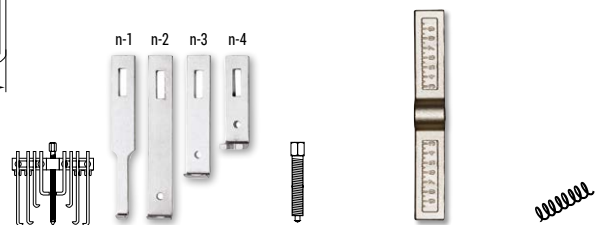
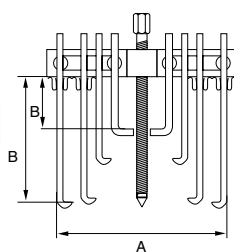
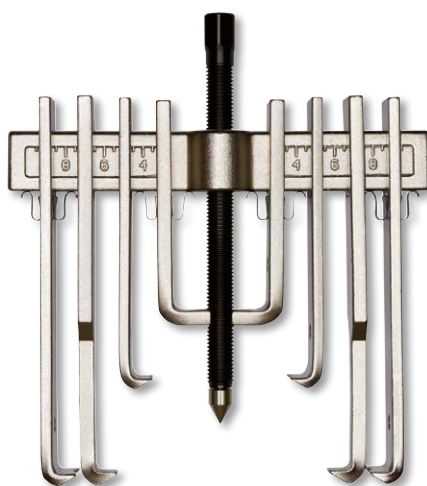

- Para ser utilizado como extractor interno o externo
- Se consigue gran longitud útil de trabajo atornillando entre sí las distintas garras

Q	Q	A (mm) min. - max.	B (mm) min. - max.	$\frac{1000}{T_n}$	g	€
713001	1	20 - 173	65 - 140	5	2.700	213,20
713011	1	75 - 250	77 - 182	10	6.000	316,43

Q	Q	€	Q	€	Q	€	Q	€	
713001	796511	n-1	21,58	796491	33,66	796501	53,63	796551	1,08
	796521	n-2	19,98						
	796531	n-3	19,98						
	796541	n-4	21,58						
713011	713511	n-1	27,89	713611	41,43	796561	105,93	796571	1,81
	713521	n-2	27,89						
	713531	n-3	29,63						
	713541	n-4	29,63						





EXTRACTORES

JUEGO DE PUNTAS EXTRACTORAS



- Juego completo de 15 extractores para cualquier tipo de espárragos o tornillos rotos
- El material NiCrMo confiere una alta calidad a las puntas
- Se suministra en una caja de plástico robusta y compacta

R	Paquete	Dimensiones	g	€
ZH1100	1	200 x 105 x 35	1.000	92,40

1/2"	ZH1101	3	4,23	5/8"	ZH1108	1/8"	4,23
	ZH1102	4	4,23		ZH1109	3/16"	4,23
	ZH1103	5	4,23		ZH1115	1/2"	4,23
	ZH1104	5.5	4,23		ZH1110	1/4"	4,23
	ZH1105	6	4,23		ZH1111	3/8"	4,23
	ZH1106	8	4,23		ZH1112	11 mm	4,23
	ZH1107	10	4,23		ZH1113	12 mm	4,23
					ZH1114	14 mm	4,23

EXTRACTORES DE ESPÁRRAGOS



- Para extraer tornillos y pernos rotos
- Acabado: granulado
- Acero al carbono de alta calidad

R	Paquete	Dimensiones	g	€
716-5-1	1	90 x 58 x 15	5	# 1, 2, 3, 4, 5 M3-M18 120 21,45
716-8-1	1	215 x 130 x 50	8	# 1, 2, 3, 4, 5, 6, 7, 8 M3-M50 840 66,45

#	Ø mm	L mm	g	€	
716-M6-1	2.0	4.00	50	M 3-6 4 3,95	
716-M8-1	2.8	4.30	58	M 6-8 6 5,53	
716-M11-1	4.0	6.00	65	M 8-11 13 7,70	
716-M14-1	6.3	7.50	75	M 11-14 20 9,46	
716-M18-1	7.5	10.70	80	M 14-18 45 11,34	
	6	10.3	15.00	85	M 18-25 95
	7	13.5	19.00	92	M 25-35 140
	8	20.6	24.00	97	M 35-50 240

VOLVEDOR



- Con carraca reversible: izda. – dcha. bloqueo
- Agarre paralelo
- Mordazas templadas
- Mango corredizo
- Acero cromado

R	Paquete	mm	L mm	g	€
718211	1	2.6 - 5.5	85	180	27,52
718231	1	4.6 - 8	110	300	35,51

TRONZATUERCAS



- Para separar tuercas atascadas sin dañar el tornillo
- Acero especial galvanizado
- Cabezal de repuesto disponible

R	Paquete	A mm	L mm	g	€
730011	1	32	126	M3-M16 6-27 440	796661 796671 57,44
730131	1	42	170	M14-M24 24-40 560	796681 796691 136,15



EXTRACTOR

EXTRACTOR MAGNÉTICO

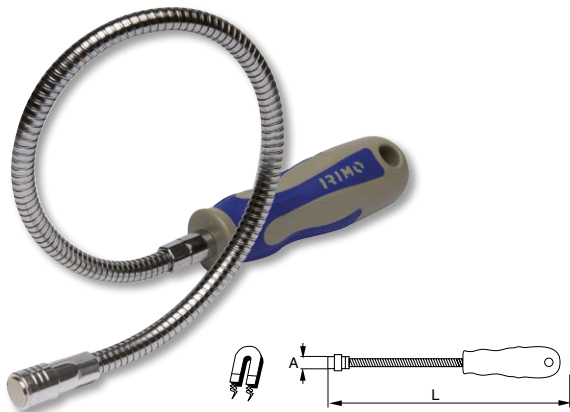

- Mango bicomponente con agujero para colgar y diseño antideslizante
- Varilla cromada pulida
- 720-1M-413: Imán neodimio extrafuerte capacidad 1 kg
- 720-3M-413: Imán neodimio extrafuerte capacidad 3 kg

Q	Icono	Ø mm	A mm	L mm	mm	mm	g	€
720-1M-413	1	10	10	550	413	110	130	31,90
720-3M-413	1	17	13	550	413	110	280	61,27

GANCHO EXTRACTOR CROMADO



- Para agarre de piezas muy pequeñas
- Eje flexible con el corazón de acero

Q	Icono	mm	g	€
720031	1	650	80	5,91

EXTRACTOR DE GARRA MAGNÉTICO CON LUZ

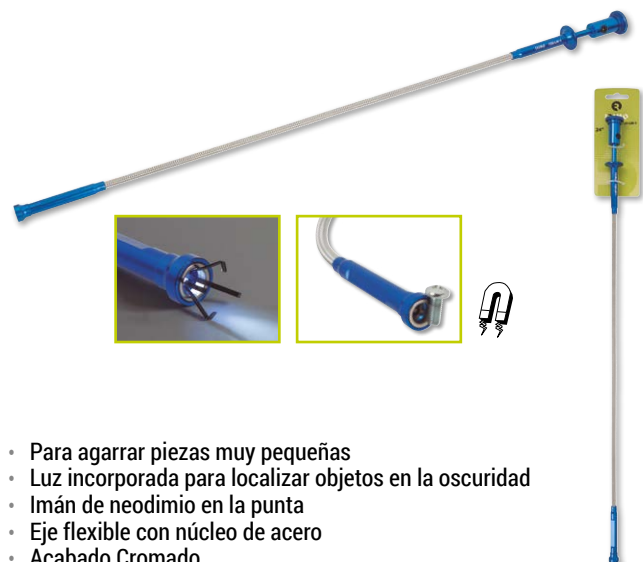

- Para agarrar piezas muy pequeñas
- Luz incorporada para localizar objetos en la oscuridad
- Imán de neodimio en la punta
- Eje flexible con núcleo de acero
- Acabado Cromado

Q	Icono	mm	g	€
720-LM-1	1	625	120	12,77

PALANCA

PALANCA

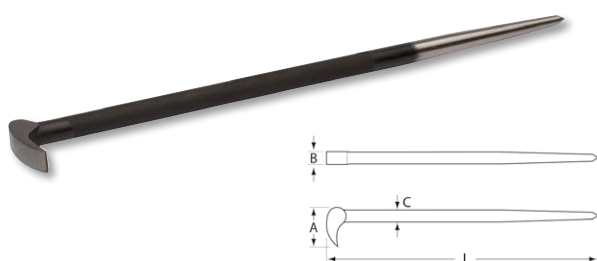

- Palanca polivalente 90° para trabajos en espacios confinados
- Acabado negro fosfatado con cabeza pulida y punta afilada
- Material: Aleación de acero especial endurecido

Q	Icono	A mm	B mm	C mm	L mm	g	€
066-400-1	1	44	14	14	406	450	34,47

1



2



3



4



5



6



7



8



9



10



11



12





PALANCA

JUEGO DE 4 PALANCAS ACODADAS



- Palancas con mangos de plástico muy ligeras
- Agarre cómodo para conseguir mayor potencia de elevación

R	Paquete	Dimensiones	Peso (g)	€
ZH70610	1	645 x 115 x 35	1.400	32,45
ZH70611, ZH70612, ZH70613, ZH70614				

PALANCA ACODADA



- Palancas con mangos de plástico muy ligeras
- Agarre cómodo para conseguir mayor potencia de elevación

R	Paquete	L (mm)	Peso (g)	€
ZH70611	1	210	200	8,68
ZH70612	1	310	300	11,16
ZH70613	1	460	400	17,35
ZH70614	1	610	500	21,07

PERFORADORES DE CHAPA

PERFORADORES DE CHAPA



- Perforadores de chapa
- Para un diámetro del agujero de 16 a 50 mm
- Zonas con superficie de corte para un corte más fácil
- Perno de cabeza hexagonal
- Para placas de chapa de acero de hasta 2 mm de espesor
- Para placas de acero inoxidable de hasta 1,2 mm de espesor
- Embalaje individual

R	Paquete	Ø mm	Hilo	Peso (g)	€
740-016-2	1	16	M 8	80	52,87
740-020-2	1	20	M 10	120	66,54
740-022-2	1	22	M 10	160	66,54
740-025-2	1	25	M 10	180	77,01
740-030-2	1	30	M 12	320	81,86
740-035-2	1	35	M 12	500	98,29
740-040-2	1	40	M 14	660	112,36
740-050-2	1	50	M 14	1.040	137,91

HUSILLO PARA PERFORADOR DE CHAPA 740



- Husillos de repuesto para perforadores de chapa de la serie 740
- Husillo estándar de M8 a M14
- Se vende en kit

R	Paquete	Ø mm	€
740S-008-2	6	M 8	1,86
740S-010-2	6	M 10	1,98
740S-012-2	6	M 12	3,10
740S-014-2	6	M 14	4,34



11. HERRAMIENTAS DE CORTE Y MEDICIÓN



ARCOS TRONZADORES Y HOJAS

ARCOS TRONZADORES



- Arco tronizador de acero con pintura en polvo
- 802-2400-1 para madera seca
- 802-3000-1 y 802-3600-1 para madera verde y mojada
- Protector incluido

R	Paquete	L mm	L"	T mm	g	oz	€
802-2400-1	5	607	24"	51	675	23.8	9,08
802-3000-1	5	759	30"	23	800	28.2	10,19
802-3600-1	5	912	36"	23	920	32.4	11,66

HOJAS DE TRONZAR, MADERA VERDE



- Ideada para aserrar madera verde y húmeda
- Acero de alta calidad templado
- Envase individual con una protección de dentado para prevenir la oxidación

R	Paquete	L mm	L"	g	oz	€
802-2423-1	10	607	24"	60	2.1	4,72
802-3023-1	10	759	30"	75	2.6	4,42
802-3623-1	10	912	36"	95	3.4	4,92

HOJAS DE TRONZAR, MADERA SECA



- Para aserrar madera seca
- Acero de alta calidad templado
- Envase individual con una protección de dentado para prevenir la oxidación

R	Paquete	L mm	L"	g	oz	€
802-2451-1	10	607	24"	65	2.3	3,83
802-3051-1	10	759	30"	80	2.8	4,42
802-3651-1	10	912	36"	100	3.5	4,92

SERRUCHOS

SERRUCHO DE COSTILLA 12"



- Especialmente adaptado para cortar madera de pequeño diámetro y para utilizar con guía de aserrado
- Mango atornillado de plástico
- Dentado universal, templado para un afilado duradero

R	Paquete	L mm	L"	T mm	g	€
800-131-1	10	300	12"	15/16	450	15,07

SERRUCHO UNIVERSAL 12"



- Serrucho universal para el corte suave de gran variedad de materiales, incluyendo aluminio, plásticos, laminados, madera y cartón
- Mango atornillado de plástico
- Ideal para transporte en cajas de herramientas
- Dentado de punta dura

R	Paquete	L mm	L"	T mm	g	€
800-151-1	4	300	12"	15/16	225	10,00



SERRUCHO EBANISTA 10"



- Para cortar madera y plástico
- Mango angulado de madera para corte biselado
- Dentado universal, templado para un afilado duradero

800-111-1	4	250	10"	15/16	240	€ 28,22
-----------	---	-----	-----	-------	-----	---------

SERRUCHO DE CALAR 12"



- Sierra de calar para todo tipo de maderas y plásticos
- Dentado universal templado para un afilado duradero
- Mango atornillado de plástico

800-141-1	4	300	12"	7/8	120	€ 17,27
-----------	---	-----	-----	-----	-----	---------

ARCO DE SIERRA DE ALUMINIO PARA METALES

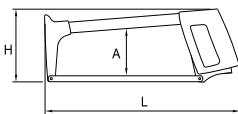
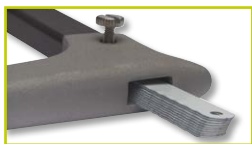

- Arco profesional muy robusto
- Suministrado con la hoja bimetálica de 24 DPP de 30 mm (12")
- Posibilidad de colocar la hoja en 55° para cortar a nivel

801101	5	400 (300)	24	748	€ 21,87
--------	---	-----------	----	-----	---------

ARCO DE SIERRA CON MANGO DE PLÁSTICO

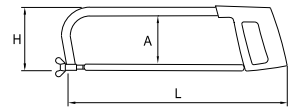

- Arco de sierra profesional y firme
- Ofrece un espacio de almacenaje de las hojas dentro de la parte negra rectangular
- Puede usarse como sierra compás
- Con opción de colocar la hoja a 55° para corte en inglete
- Se suministra con una hoja de sierra bimetálica de 24 DPP

801-041-1	10	110	151	400	665	€ 13,11
-----------	----	-----	-----	-----	-----	---------

HOJA BIMETAL



- Hoja bimetálica inastillable con dentado de precisión para todo tipo de corte en metal
- La hoja bimetálica garantiza el afilado duradero
- Envase: 5 hojas en un embalaje especial con asa para colgar

803-318-5	5	300 x 13 x 0.65	18	17	€ 9,79
803-324-5	5	300 x 13 x 0.65	24	17	€ 9,79
803-332-5	5	300 x 13 x 0.65	32	17	€ 9,79



- Envase: 50 hojas en caja de plástico

803-318-50	50	300 x 13 x 0.65	18	17	€ 1,96
803-324-50	50	300 x 13 x 0.65	24	17	€ 1,96
803-332-50	50	300 x 13 x 0.65	32	17	€ 1,96

1



2



3



4



5



6



7



8



9



10



11



12





SERRUCHOS

MINI ARCO DE ALUMINIO



- Un mini arco muy útil para cortar en lugares difíciles
- De muy fácil manejo
- Se suministra con una hoja de sierra de 24 DPP

€	📦	H mm	L mm	g	€
801-145-1	5	51	229	140	13,46

ARCO DE SIERRA DE METAL CON MANGO DE MADERA

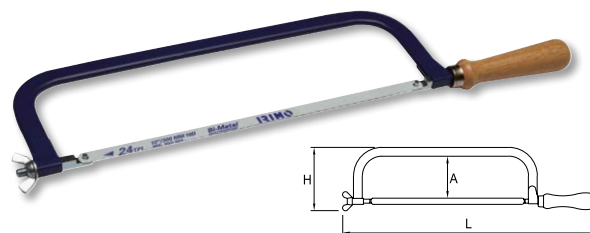

- Arco tradicional, de fácil uso

€	📦	A mm	H mm	L mm	g	€
801-011-1	10	100	128	512	575	13,95

CORONAS

JUEGO 6 CORONAS BI-METAL



- Juego:
 - 6 coronas bi-metales 22, 29, 35, 44, 51, 64 mm
 - Pequeño soporte
 - 1 broca de repuesto
- Estuche con foam bi-color

€	📦	X	📦	g	€
810-2264-4	1	9	230 x 180 x 70	1.000	68,82

LIMAS

PLANA PUNTA

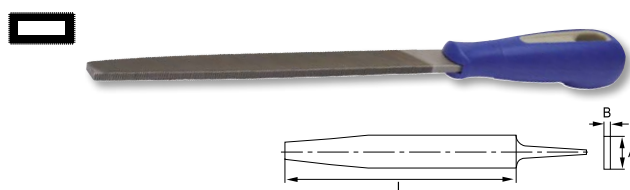

- Plana con punta
- Para limar superficies planas, esquinas, la forma de su punta facilita el acceso en ángulos y esquinas

€	📦	L mm	A mm	B mm	🔪	🔪	g	€
BASTA								
534521	6	150 / 6"	16	4	13	33	90	8,44
534531	6	200 / 8"	20	5	10	25	160	9,35
534541	6	250 / 10"	25	5.5	9	23	250	11,95
534551	6	300 / 12"	30	6	8	20	413	14,94
ENTREFINA								
534251	6	150 / 6"	16	4	18	46	50	8,51
534261	6	200 / 8"	20	5	14	36	160	9,48

PLANA PARALELA

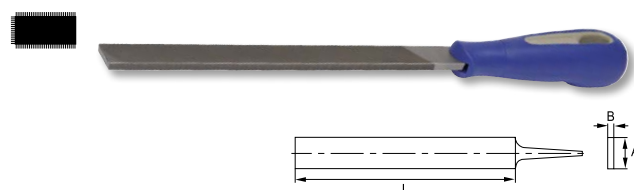

- Plana paralela basta
- Picado de doble superficie, un canto con picado simple, sin picado

€	📦	L mm	A mm	B mm	🔪	🔪	g	€
BASTA								
534561	6	150 / 6"	16	4	13	33	90	8,44
534571	6	200 / 8"	20	5	10	25	160	9,35
ENTREFINA								
534281	6	150 / 6"	16	4	18	46	50	8,51
534291	6	200 / 8"	20	5	14	36	160	9,48



MEDIA CAÑA

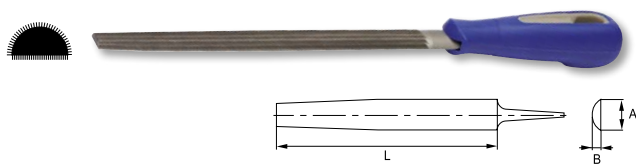

- Para limar superficies planas, cóncavas y grandes agujeros
Ideal para desbastado

🌀	📦	L mm	A mm	B mm	🔧	🔧	📦	€
BASTA								
534681	6	150 / 6"	16	4.7	13	33	100	10,19
534691	6	200 / 8"	20.5	6	10	25	170	11,69
534701	6	250 / 10"	26.5	7.5	9	23	344	15,48
ENTREFINA								
534371	6	150 / 6"	16	4.7	18	46	100	10,19
534381	6	200 / 8"	20.5	6	14	36	170	12,26

REDONDA



- Para limar agujeros, superficies cóncavas
- Picado de superficies doble

🌀	📦	L mm	A mm	B mm	🔧	🔧	📦	€
BASTA								
534601	6	150 / 6"	16	4.7	13	33	100	7,08
534611	6	200 / 8"	20.5	6	10	25	170	8,56
534621	6	250 / 10"	26.5	7.5	9	23	344	10,87
ENTREFINA								
534311	6	150 / 6"	16	4.7	18	46	100	7,40
534321	6	200 / 8"	20.5	6	14	36	170	8,96

TRIANGULAR

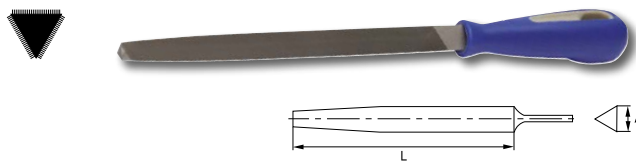

- Para afilado y desbastado en ángulos, esquinas interiores, superficies cóncavas y limados planos
- Picado de superficies doble

🌀	📦	L mm	A mm	🔧	🔧	📦	€
BASTA							
534901	6	150 / 6"	11	13	33	94	7,51
534911	6	200 / 8"	15.5	10	25	203	7,78
ENTREFINA							
534341	6	150 / 6"	11	18	46	94	8,64
534351	6	200 / 8"	15.5	14	36	203	11,23

CUADRADA

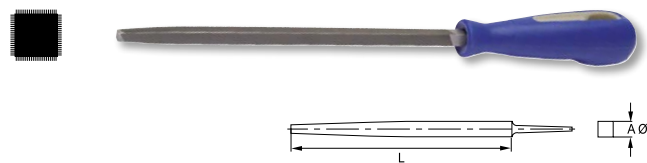

- Para limar ranuras, agujeros cuadrados y rectangulares, esquinas interiores y ajuste fino
- Picado de superficies doble

🌀	📦	L mm	A mm	🔧	🔧	📦	€
BASTA							
534931	6	150 / 6"	6	13	33	79	6,56
534941	6	200 / 8"	8	10	25	132	6,78
ENTREFINA							
534401	6	150 / 6"	6	18	46	79	5,89
534411	6	200 / 8"	8	14	36	132	6,18

JUEGO 6 LIMAS 8"



🌀	📦	📦	📦	📦	€
534501	1	6	44 x 37 x 3	1.150	67,36
534261	📦			534351	📦
534291	📦			534381	📦
534321	📦			534411	📦

1

2

3

4

5

6

7

8

9

10

11

12



NIVELES

NIVEL



* sin asas: 982-40-1
982-4M-1



* con asas: 982-60-1
982-80-1
982-6M-1

- Precisión ± 1 mm/m
- Alta visibilidad
- Tres fiolas tipo barril: Horizontal, vertical, 45°
- Aluminio ligero
- Diseño robusto de perfil. Superficies de apoyo tratadas
- Pintura epoxy de gran durabilidad

R		A mm	B mm	L mm	g	€
982-40-1	1	24	60	400	300	13,65
982-60-1	1	24	60	600	360	16,61
982-80-1	1	24	60	800	550	22,63

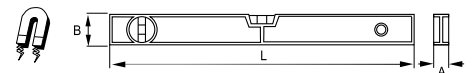

- Dos potentes imanes
- Necesarios 9 Newtons para separarlos entre sí
- Tres fiolas tipo barril: Horizontal, vertical, 45°

R		A mm	B mm	L mm	g	€
982-4M-1	1	22	60	400	280	15,25
982-6M-1	1	24	60	600	370	27,71

NIVEL



NIVEL MAGNÉTICO

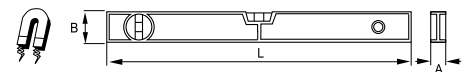
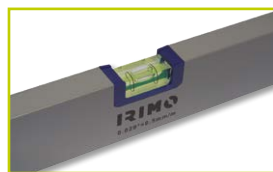
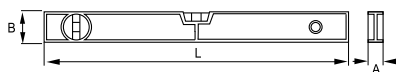

- Perfil de aluminio, ligero, 450 g/m
- Perfil ligero, fácil de transportar, tamaño 20 x 49 mm
- Precisión $\pm 0,5$ mm/m
- Fiolas de gran visibilidad
- Tres fiolas: horizontal, vertical y 45°
- Tapones protectores
- Pintura epoxy de larga duración

R		A mm	B mm	L mm	g	€
981-400-1	1	20	49	400	175	10,27
981-600-1	1	20	49	600	215	12,51
981-800-1	1	20	49	800	275	17,04
981-1000-1	1	20	49	1.000	325	19,19
981-1200-1	1	20	49	1.200	380	20,94
981-1500-1	1	20	49	1.500	480	24,42
981-1800-1	1	20	49	1.800	550	28,79
981-2000-1	1	20	49	2.000	605	30,55

- Perfil de aluminio
- Perfil ligero, fácil de transportar, tamaño 22 x 49 mm
- Precisión $\pm 0,5$ mm/m
- Fiolas de gran visibilidad
- Tres fiolas: horizontal, vertical y 45°
- Incluye dos imanes
- Tapones protectores
- Pintura epoxy de larga duración

R		A mm	B mm	L mm	g	€
981-400M-1	1	22	49	400	300	15,11
981-600M-1	1	22	49	600	450	18,74



JUEGO DE NIVELES, 2 piezas

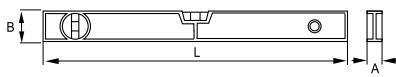

- Juego de dos niveles:
- Nivel tubular de 600 mm + torpedo 982-TOR
- Fiolas de alta visibilidad y baja densidad

€		A mm	B mm	L mm	g	€
982-SET	1	55	60	600	410	13,84

JUEGO DE 3 NIVELES DE BURBUJA



- Juego de 3 niveles: 600, 1200 y 2000 mm
- Precisión $\pm 0,5$ mm/m
- Viales de alta visibilidad
- Tres viales: horizontal, vertical y 45°
- Tapas protectoras para los extremos
- Pintura epoxi de larga duración

€				g	€
981-SET	1	3	600 + 1200 + 2000 mm	1.200	65,42

NIVEL "TORPEDO"



- Imán en la base
- Adecuado para fontaneros
- 3 viales: horizontal, vertical y de 45°
- Precisión de ± 1 mm/m en la fiola horizontal
- Precisión de ± 1 mm/m en las fiolas verticales
- Líquido de alta visibilidad en el interior de las fiolas

€		A mm	B mm	L mm	g	€
982-TOR-1	1	15	40	230	80	8,04

NIVEL DE BOLSILLO 100 MM

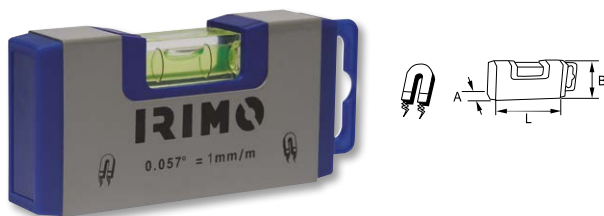

- Tamaño ideal para llevar en el bolsillo, 10 cm
- Precisión: ± 1 mm/m
- Fiola de alta visibilidad
- 2 fuertes imanes en la base que aguantan hasta 500 g

€		A mm	B mm	L mm	g	€
982-10-1	1	20	50	100	60	6,20

JUEGO NIVEL TORPEDO BASE MAGNÉTICA CON ESTUCHE



- Juego de nivel de aluminio con base magnética y estuche nylon para transporte fácil
- Precisión de ± 1 mm/m en todas las fiolas
- 3 fiolas: horizontal, vertical y de 45°
- Pareja de imanes fuertes de neodimio en la base

€			g	€
983-25-1	5	240 x 140 x 25	315	18,60

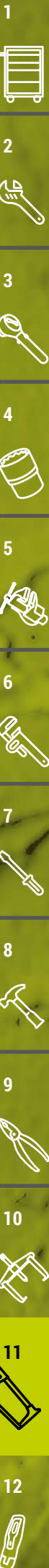



FLEXÓMETROS

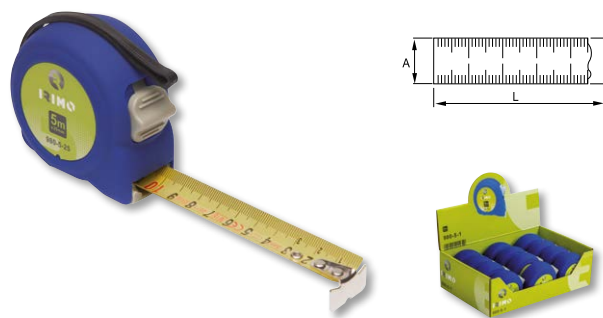

- Clase II de precisión acorde a la normativa UE de instrumentos de medición
- Cuerpo ABS
- Sistema de bloqueo
- Cinta para la muñeca
- Clip trasero para colgar del cinturón
- Hoja de Acero 50C alta calidad

* Suministrado en caja expositora si se piden 12 unidades

R		A mm	L m	g	€
980-3-1	12	16	3	140	3,76
980-5-1	12	19	5	180	5,37
980-5-25-1	12	25	5	175	9,11

- Clase II de precisión acorde a la normativa UE de instrumentos de medición
- Cuerpo ABS con recubrimiento de goma
- Sistema de bloqueo
- Cinta para la muñeca
- Clip trasero para colgar del cinturón
- Hoja de Acero 50C alta calidad

* Suministrado en caja expositora si se piden 12 unidades

R		A mm	L m	g	€
980-3B-1	12	16	3	125	5,86
980-5B-1	12	19	5	195	9,49
980-8B-1	12	25	8	370	18,50

PACK DE 2 FLEXÓMETROS 3 Y 10 M



- Clase II de precisión
- Cinta para la muñeca
- Clip trasero para colgar del cinturón
- Medidas: 3 m x 16 mm, 10 m x 25 mm

R				g	€
980-TP2-1	12	2	170 x 80 x 42	549	17,85

FLEXÓMETROS REFLECTANTES

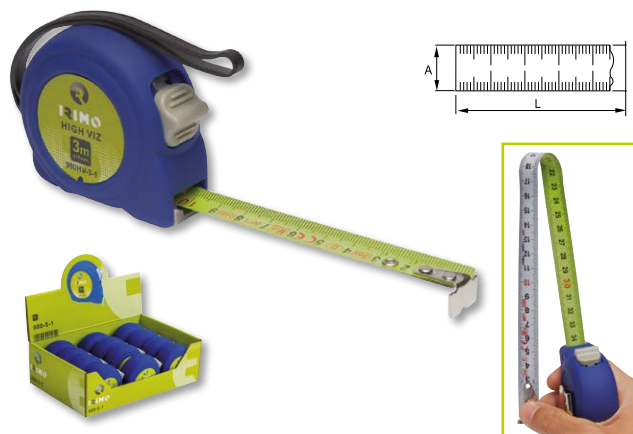

- Cinta de color verde especial para una mayor visibilidad
- Marcado vertical en la parte de posterior: permite una sencilla medición y marcado en vertical
- Cumple con la directiva UE para instrumentos de medición
- Exactitud: Clase II
- Carcasa ABS con recubrimiento de goma
- Instalación de cierre
- Correa para la muñeca
- Clip de metal para el cinturón
- Cinta de alta calidad de nylon de 50C con un recubrimiento resistente a la abrasión
- 3 remaches en el gancho final

* Suministrado en caja expositora si se piden 12 unidades

R		A mm	L m	g	€
980HV-3-1	12	16	3	105	6,05
980HV-5-1	12	19	5	175	8,75



FLEXÓMETROS PARA MEDIR VERTICALMENTE

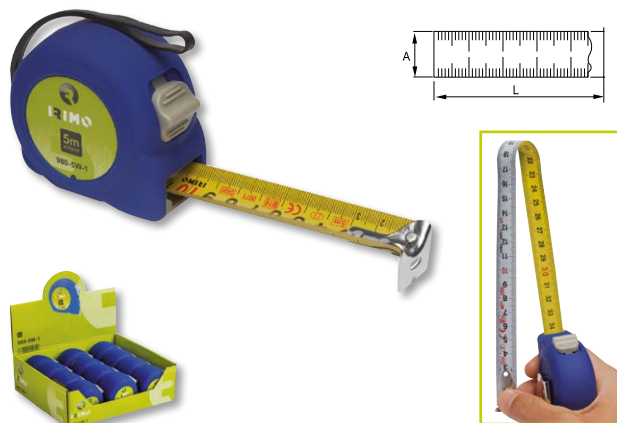

- Cinta de métrica de 5 m x 30 mm de ancho
- Marcado en mm en ambos lados
- Marcado vertical en la parte posterior
- * Suministrado en caja expositora si se piden 12 unidades

R		A mm	L m	g	€
980-5W-1	12	30	5	295	10,34

CINTA MÉTRICA



- Clase II de precisión acorde a la normativa UE de instrumentos de medición
- Cuerpo ABS con recubrimiento de goma
- Cinta con anilla en la punta y gancho plegable
- Clip para colgar del cinturón
- Sistema de recogida rápida con manivela
- Hoja de Acero 50C alta calidad
- Caja individual colgable

R		A mm	L m	g	€
980-20S-1	12	13	20	350	15,23

REGLA PLEGABLE DE MADERA



- Regla plegable con 10 hojas de madera
- Madera de abedul, flexible y resistente
- Barniz especial resistente a la abrasión
- Clase II de precisión acorde a la normativa UE de instrumentos de medición

R		A mm	L m	g	€
985-2-1	1	16	2	115	4,22

1



2



3



4



5



6



7



8



9



10



11



12





ESCUADRAS

ESCUADRAS



- Escala en mm
- Hoja de acero inoxidable
- Mango de aluminio

R		L mm	g	€
991-200-1	1	200	230	8,46
991-250-1	1	250	250	10,27
991-300-1	1	300	290	12,09
991-400-1	1	400	330	14,75

ESCUADRAS COMBINADAS

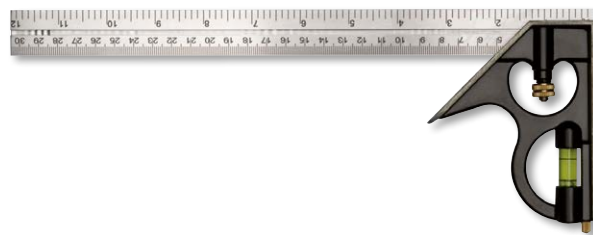

- Escala en mm y pulgadas
- Hoja de acero inoxidable
- Incluye nivel con precisión de 1 mm/m
- Mango de zinc y partes de latón

R		L mm	g	€
993-150-1	1	150	200	11,48
993-300-1	1	300	230	16,33
993-400-1	1	400	260	18,74

GALGAS

GALGAS DE ROSCAS



- Longitud de hoja: 70 mm

R		52 hojas	g	€
972-52-1	25	52 hojas	65	12,12
Métrica 60° - 0,25 a 6 mm 0,25-0,30-0,35-0,40-0,45-0,50-0,60-0,70-0,75-0,80-0,90-1-1,25-1,50-1,75-2-2,5-3-3,5-4-4,5-5-5,5-6				
Whitworth 55° - 4 a 62 hilos" 4-4,5-5-6-7-8-9-10-11-12-13-14-16-18-19-20-22-24-25-26-28-30-32-36-40-48-60-62				

GALGAS DE ESPESORES

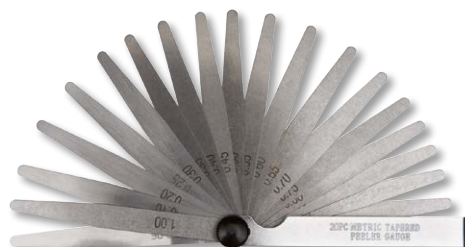

- Longitud de hoja: 100 mm

R		13 hojas	g	€
971-13-1	5	13 hojas	52	8,18
0,05 a 1 mm 0,05-0,10-0,15-0,20-0,25-0,30-0,40-0,50-0,60-0,70-0,80-0,90-1				
971-20-1	5	20 hojas	83	10,83
0,05 a 1 mm 0,05-0,10-0,15-0,20-0,25-0,30-0,35-0,40-0,45-0,50-0,55-0,60-0,65-0,70-0,75-0,80-0,85-0,90-0,95-1				



CALIBRES

CALIBRE VERNIER 150 MM



- Calibre vernier
- Precisión $\pm 0,03$ mm
- Fabricado en acero inoxidable endurecido
- Incluye caja de plástico para un almacenamiento seguro

984-6-1	1	0-150	0-6"	235	25 x 90 x 245	150	30,10

CALIBRE DIGITAL ACERO INOXIDABLE 150 MM

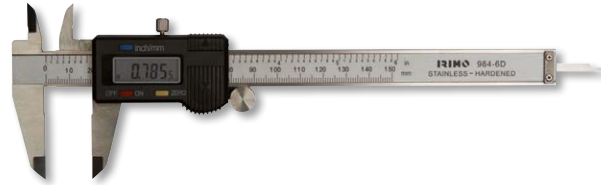

- Calibre vernier digital
- Precisión $\pm 0,03$ mm
- Fabricado en acero inoxidable endurecido
- Incluye caja de plástico para un almacenamiento seguro

984-6D-1	1	0-150	0-6"	235	25 x 90 x 245	150	42,08

TERMÓMETRO INFRARROJOS



- Medición de temperatura sin contacto
- Rango de medición: -50 a 420 °C (-58 a 788 °F)
- Con puntero láser
- Precisión: 0 a 420 °C, $\pm 1,5\%$
-50 a 0 °C, $\pm 3\%$
- Resolución: 0,1 °C
- Repetibilidad de la lectura: 1 % o 1 °C
- Tiempo de respuesta: 500 ms
- Distancia hasta el punto medición: L12 a D1
- Batería de 9V no incluida

LT-420-1	1	155	170	42,31

1



2



3



4



5



6



7



8



9



10



11



12





ESPÁTULAS

ESPÁTULAS

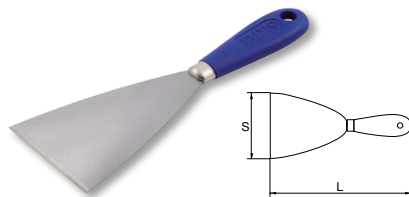

- Hoja templada de 1,5 mm de grosor / 0,5 mm en el filo
- Excelente flexibilidad
- Pulida y barnizada de larga durabilidad
- Virola metálica para la perfecta unión entre hoja y mango
- Mango de plástico con agujero para colgar
- DIN 7216, UNE 16608

€		S mm	L mm		€
540021	12	20	220	50	3,23
540031	12	30	220	55	3,25
540041	12	40	220	60	3,37
540051	12	50	220	65	3,49
540061	12	60	220	70	3,59
540071	12	70	220	75	3,88
540081	12	80	220	80	4,09
540091	12	90	220	85	4,39
540101	12	100	220	90	4,92
540121	12	120	220	100	5,76

JUEGO DE ESPÁTULAS DE CARROCERO



- Juego de espátulas de carrocero, 4 piezas
- Cuchilla de acero al carbono
- Excelente flexibilidad y máxima durabilidad
- Cuchilla pulida y barnizada para evitar la oxidación
- Se suministra en una bolsa de plástico

€					€
536011	1	4	160x130	120	16,39

90x50 mm, 120x80 mm, 120x105 mm, 120x120 mm

HERRAMIENTAS DE APRIETE

PISTOLA DE SILICONA

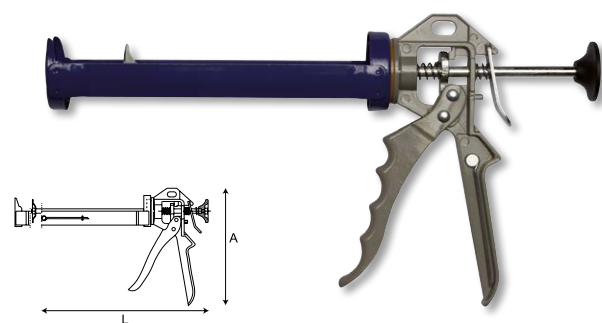

- Pistola de silicona para cartuchos de 9"
- Idónea para mayoría de resinas y siliconas
- Asa y gatillo fabricado en aluminio
- Cuerpo giratorio para facilitar la carga del cartucho
- Aguja incorporada
- Ratio de descarga 7:1
- Fuerza máxima de empuje 1500N

€		A mm	L mm		€
549-230-2	1	200	330	550	8,48

PISTOLA DE COLA TERMOFUSIBLE



- Con interruptor On-Off para ahorro de energía
- Normativa CE/GS
- Boquilla protectora para mayor durabilidad y seguridad
- Incluye dos boquillas adicionales y una válvula de seguridad para prevenir goteos involuntarios
- Gacho plegable para mantener la pistola en reposo
- Potencia de 80W; Voltaje 220-240V; Precalentamiento 3-5 minutos; Flujo de encolado 14-15 g por minuto. Cable de 1,6 m
- Contiene 12 barras de cola 11,2x150 mm (6 uso general, 6 cola extrafuerte)
- Embalaje en blíster

€				€
550-80-4	1	40x190x190	250	30,24



PISTOLA DE CALOR 2000W



- Pistola de calor temperatura regulable 2000W
- Pantalla led para ajuste de temperatura
- 12 valores de ajuste de temperatura
- 2 opciones de flujo de aire diferentes:
 - Velocidad 1: 250 l/min - 50 °C, 100 °C, 150 °C, 200 °C, 250 °C, 350 °C
 - Velocidad 2: 550 l/min - 100 °C, 200 °C, 300 °C, 400 °C, 500 °C, 600 °C
- Sistema de enfriamiento automático: 280 l/min - 50 °C
- Modo manos libres

€				g	€
551-HG-1	1	200 x 65 x 240		560	61,80

GRAPADORA 4 EN 1



- Kit con quitagrapas que incluye una caja con 1000 grapas
- Grapadora compacta y polivalente
- Ajuste de potencia alto-bajo para controlar la intensidad de la aplicación
- La ventana de grapas proporciona una clara visibilidad para determinar cuándo es necesario recargar las grapas
- Mecanismo anti-atasco para un uso continuo y un funcionamiento fiable
- Agarre con bloqueo para un almacenamiento y transporte seguros
- Clip para el cinturón

€				g	€
560-41LP-1	3	170x290x40		690	23,11

BOQUILLAS PARA PISTOLA DE CALOR



- 4x boquillas de pistola de calor
- Cuatro boquillas diferentes, una para cada tipo de trabajo
- Compatible con pistola de calor 551-HG-1

€				g	€
551-NOZ-1	1	4	5 x 110 x 150	10	4,02

GRAPADORA MARTILLO



- Kit con caja de 1000 grapas
- Grapadora martillo compacta con carcasa de acero
- Mecanismo anti-atasco para un uso continuo y un funcionamiento fiable
- Mango ergonómico para un mejor agarre y manejo

€				g	€
560-HTS-1	6	115x350x32		520	13,03

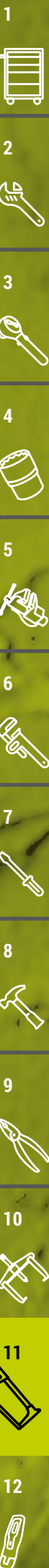



HERRAMIENTAS DE APRIETE

GRAPADORA 4 EN 1



- Grapadora compacta y polivalente
- Ajuste de potencia alto-bajo para controlar la intensidad de la aplicación
- La ventana de grapas proporciona una clara visibilidad para determinar cuándo es necesario recargar las grapas
- Mecanismo anti-atasco para un uso continuo y un funcionamiento fiable
- Agarre con bloqueo para un almacenamiento y transporte seguros
- Clip para el cinturón
- Compatible con:
 - Grapas heavy duty (1,2): 6-14 mm (1/4"-9/16")
 - Grapas ligeras (0,7): 6-14 mm (1/4"-9/16")
 - Grapas para cables: 10-14 mm (3/8"-9/16")
 - Clavos tipo clavo 18: 15 mm (19/32")

€	Icono	Icono	Icono	g	€
560-41-1	3	170x290x40		690	20,42

GRAPAS HEAVY DUTY

x1000



- Para trabajos pesados de grapado como el aislamiento, alfombras o tela asfáltica
- Para tejidos, telas, alfombras, cartón, listones planos de madera, madera, cartón y malla metálica

€	Icono	A mm	B mm	C mm	Icono	g	€
560-HD-06	12	1.2	11.3	6	40x28x80	110	2,43
560-HD-08	12	1.2	11.3	8	65x35x80	137	2,68
560-HD-10	12	1.2	11.3	10	65x35x80	158	2,77
560-HD-12	12	1.2	11.3	12	65x35x80	172	2,90
560-HD-14	12	1.2	11.3	14	65x35x80	195	3,03

GRAPAS TIPO CLAVO 15 MM

x1000



- Para trabajos de artesanía y carpintería

€	Icono	A mm	B mm	C mm	Icono	g	€
560-BN-15	12	1.2	2	15	40x28x80	122	1,99

GRAPADORA MARTILLO



- Grapadora martillo compacta con carcasa de acero
- Mecanismo anti-atasco para un uso continuo y un funcionamiento fiable
- Mango ergonómico para un mejor agarre y manejo

€	Icono	Icono	Icono	g	€
560-HT-1	6	115x350x32		520	12,48

GRAPAS

x1000



- Para trabajos domésticos ligeros y manualidades

€	Icono	A mm	B mm	C mm	Icono	g	€
560-LD-06	12	0.7	11.3	6	40x28x80	70	1,83
560-LD-08	12	0.7	11.3	8	65x35x80	88	2,05
560-LD-10	12	0.7	11.3	10	65x35x80	102	2,08
560-LD-12	12	0.7	11.3	12	65x35x80	112	2,17
560-LD-14	12	0.7	11.3	14	65x35x80	117	2,24

GRAPAS PARA CABLES

x1000



- Para cables de bajo voltaje

€	Icono	A mm	B mm	C mm	Icono	g	€
560-CA-10	12	1.2	7.5	10	65x35x80	127	2,77
560-CA-12	12	1.2	7.5	12	65x35x80	145	2,90
560-CA-14	12	1.2	7.5	14	65x35x80	151	3,03



12. ILUMINACIÓN Y HERRAMIENTAS NEUMÁTICAS Y A BATERÍA



LÁMPARAS DE BOLSILLO

LÁMPARA FLEXIBLE



- LED COB (principal) / 1xSMD (linterna)
- LUMENS: 400 lm (principal) / 70 lm (linterna)
- Batería:
 - Material: Litio 3.7V 2000 mAh
 - Tiempo de funcionamiento: 3 h (principal) / 10 h (linterna)
 - Tiempo de carga: 3 h
 - Puerto de carga: Micro USB
- Dos opciones de intensidad de luz
- Incluye un cable micro USB de 1 m
- Temperatura: 5700 K
- CRI: >70
- IP54 / IK07
- CE-EMC / RoHS / Reach

L-FLEX-1	1	400	70	✓	3/10	3.5	74 x 262 x 45	307	57,02

LÁMPARA COMPACTA



- LED COB (principal) / 1xSMD (linterna)
- LUMENS: 600 lm (principal) / 100 lm (linterna)
- Batería:
 - Material: Litio 3.7V 2000 mAh
 - Tiempo de funcionamiento: 2,5 h (principal) 6 h (linterna)
 - Tiempo de carga: 3 h
 - Puerto de carga: Micro USB
- Incluye un cable micro USB de 1 m
- Temperatura: 5700 K
- CRI: >80
- IP54 / IK07
- CE-EMC / RoHS / Reach

L-COMP-1	1	600	100	✓	2.5/6	3	75 x 207 x 38	223	48,84

DELGADA FLEX



- LED COB (principal) / 1xSMD (linterna)
- LUMENS: 400 lm (principal) / 70 lm (linterna)
- Batería:
 - Material: Litio 3.7V 2000 mAh
 - Tiempo de funcionamiento: 3-8 h (principal) 8 h (linterna)
 - Tiempo de carga: 3 h
 - Puerto de carga: Micro USB
- Regulador de intensidad de la luz mediante rueda con el pulgar
- Incluye un cable micro USB de 1 m
- Temperatura: 5700 K
- CRI: >70
- IP20 / IK07
- CE-EMC / RoHS / Reach

L-SLIM-1	1	400	70	✓	3/8	3	82 x 168 x 36	200	52,34





MINI LÁMPARA FLEXIBLE



- LED SMD 4+1
- LUMENS: 250 lm (principal) / 70 lm (linterna)
- Batería:
 - Material: Litio 3.7V 1000 mAh
 - Tiempo de funcionamiento: 3 h (principal) 7 h (linterna)
 - Tiempo de carga: 3 h
 - Puerto de carga: Micro USB
- Incluye un cable micro USB de 1 m
- Temperatura: 5700 K
- CRI: >80
- IP20 / IK07
- CE-EMC / RoHS / Reach

Icono	Q	Paquete	lm	lm	h	h	Paquete	g	€
L-MINI-1	1	250	70	✓	3/7	3	53 x 195 x 53	130	33,72

LÁMPARA FLEXIBLE DE BOLSILLO



- LED SMD 4+1
- LUMENS: 250 lm (principal) / 70 lm (linterna)
- Batería:
 - Material: Litio 3.7V 1000 mAh
 - Tiempo de funcionamiento: 2-2,5 h (principal) 6 h (linterna)
 - Tiempo de carga: 3 h
 - Puerto de carga: Micro USB
- Incluye un cable micro USB de 1 m
- Temperatura: 5700 K
- CRI: >80
- IP20 / IK07
- CE-EMC / RoHS / Reach

Icono	Q	Paquete	lm	lm	h	h	Paquete	g	€
L-POCK-1	1	250	70	✓	2,5/6	3	73 x 138 x 45	220	31,40

LÁMPARAS DE INSPECCIÓN

LINTERNA DE ALUMINIO



- LED COB
- LUMENS: 100 lm
- Batería:
 - 3AAA incluidas
 - Tiempo de funcionamiento: 9 h
- Cuerpo de aluminio
- Botón de goma de fácil apriete
- Correa para colgarlo
- Temperatura: 6500 K
- CRI: >70
- IP44
- CE-EMC / RoHS

Icono	Q	Paquete	lm	Batería	Paquete	g	€
L-ALUM-1	1	100	3AAA	100 x 45 x 35	100	5,23	
L-ALUM-12DISP	1			105 x 220 x 170	1.050	62,80	

LÁMPARA TIPO BOLI



- LED SMD 6+1
- LUMENS: 150 lm (principal) / 70 lm (linterna)
- Batería:
 - Material: Litio 3.7V 600 mAh
 - Tiempo de funcionamiento: 2,5 h (principal) 3,5 h (linterna)
 - Tiempo de carga: 2 h
 - Puerto de carga: USB tipo C
- Incluye un cable micro USB de 1 m
- Temperatura: 5700 K
- CRI: >80
- IP20 / IK07
- CE-EMC / RoHS / Reach

Icono	Q	Paquete	lm	lm	h	h	Paquete	g	€
L-PEN-1	1	150	70	✓	2,5/3,5	2	39 x 164 x 18	390	22,09





LÁMPARAS DE TRABAJO

LÁMPARA DE TRABAJO



POWER BANK



- LED 27xSMD
- Dos opciones de intensidad
- LUMENS: 500 lm / 1000 lm
- Batería:
 - Material: Litio 3.7V 4000 mAh
 - Tiempo de funcionamiento: 6 h / 500 lm, 3 h / 1000 lm
 - Tiempo de carga: 2,5-3 h / 5V 2A
 - Puerto de carga: Micro USB
- Funcionalidad de depósito de energía
- Mango giratorio 270°
- Incluye un cable micro USB de 1 m
- Temperatura: 6000 K
- CRI: >80
- IP54 / IK08
- CE-EMC / RoHS / Reach

L-BOOK-1	1	500/1000	3/6	3	182 x 142 x 52	400	52,34

LÁMPARAS FRONTALES

LINTERNA PARA LA CABEZA



- LED SMD
- LUMENS: 400 lm
- Batería:
 - Material: Litio 3.7V 2200 mAh
 - Tiempo de funcionamiento: 5 h
 - Tiempo de carga: 4 h
 - Puerto de carga: Micro USB
- Dos opciones de intensidad y parpadeo en el frente
- Luz roja trasera con opción de parpadeo
- Correa ajustable
- Cabeza giratoria
- Zoom para un mejor enfoque
- Incluye un cable micro USB de 1 m
- Temperatura: 6000 K
- CRI: >70
- IP44
- CE-EMC / RoHS / Reach

L-HEAD-1	1	5	4	118 x 87 x 64	125	29,08

LINTERNA PARA LA CABEZA



- Cob LED 350ml con XPE lateral 90ml
- Batería:
 - Material: Litio 3.7V y 1200 mAh
- Dos opciones de intensidad y luz intermitente
- Modo de activación por sensor de movimiento para apagar/encender sin contacto
- Correa ajustable
- Cable de carga USB incluido
- IPX4
- CE-EMC / RoHS / Reach

L-FRONT-1	1	150	x	8	2.5	IPX4	6000	40 x 60 x 100	70	17,66



LLAVE IMPACTO 1/2"

P-IW-12



- Llave de impacto neumática de 1/2", 1600 N·m
- Potente mecanismo de doble martillo
- Carcasa de composite ligera, duradera y aislada
- Mango soft grip antideslizante
- Sencillo cambio de sentido hacia adelante y hacia atrás con una sola mano
- Regulador de potencia de tres pasos
- Mecanismo de gatillo progresivo
- Silenciador integrado
- * Kit de mantenimiento disponible: P-IW-12-01

P-IW-12C



- Llave de impacto neumática de 1/2" compacta, 1200 N·m
- Potente mecanismo de doble martillo
- Carcasa de composite ligera, duradera y aislada
- Mango soft grip antideslizante
- Sencillo cambio de sentido hacia adelante y hacia atrás con una sola mano
- Regulador de potencia de tres pasos
- Mecanismo de gatillo progresivo
- Silenciador integrado
- * Kit de mantenimiento disponible: P-IW-12C-01

P-IW-12P



- Llave de impacto neumática de 1/2" de alta potencia, 2230 N·m
- Potente mecanismo de doble martillo
- Carcasa de composite ligera, duradera y aislada
- Mango soft grip antideslizante
- Sencillo cambio de sentido hacia adelante y hacia atrás con una sola mano
- Regulador de potencia de tres pasos
- Mecanismo de gatillo progresivo
- Silenciador integrado
- * Kit de mantenimiento disponible: P-IW-12P-01

P-IW-34



- Llave de impacto neumática de 3/4", 2298 N·m
- Potente mecanismo de doble martillo
- Carcasa de composite ligera, duradera y aislada
- Mango soft grip antideslizante
- Sencillo cambio de sentido hacia adelante y hacia atrás con una sola mano
- Regulador de potencia de tres pasos
- Mecanismo de gatillo progresivo
- Silenciador integrado
- * Kit de mantenimiento disponible: P-IW-34-01



Modelo	Paquete	Tamaño	BAR	Acople	Longitud	Peso	Velocidad	Par Máx.	Velocidad	Velocidad	Velocidad	Velocidad	Velocidad	Peso	Precio
P-IW-12	1	1/2"	6.3	1/4" - 19	10	184	680-730	1600	8.500	1.000	110	6.34	185	2.1	144,20
P-IW-12C	1	1/2"	6.3	1/4" - 19	10	184	500-580	1200	10.500	1.250	110	6.34	125	1.25	157,59
P-IW-12P	1	1/2"	6.3	1/4" - 19	10	184	1050-1150	2230	7.500	1.000	110	6.34	195	2.3	183,34
P-IW-34	1	3/4"	6.3	1/4" - 19	10	184	1080-1150	2298	7.500	1.000	110	6.34	195	2.37	252,35





CARRACA 1/4"

P700

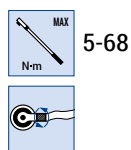

CARRACA 1/2"

P821



• Composite

Modelo	Caja	Tamaño	Presión (BAR)	Conector (inch)	Longitud (mm)	Alargador (mm)	Rango (N-m)	Velocidad (rpm)	Peso (kg)	Longitud (mm)	Peso (kg)	Precio (€)	
P700	1	1/4"	6.3	1/4" - 18	10	136	0 - 27	300	94.00	3.60	133	0.50	163,78
P821	1	1/2"	6.3	1/4" - 18	10	120	0 - 67	150	80.00	2.60	256	1.20	204,74

SOPLADORA



Modelo	Caja	Presión (BAR)	Peso (kg)	Precio (€)
P218	1	6.3	135	10,72

CONECTORES RÁPIDOS



PM5002
PM5003



PM5012
PM5013



PM5142
PM5143



PM5152
PM5153



PM5248

Modelo	Caja	Tamaño (inch)	Descripción	Peso (g)	Precio (€)
PM5002 PM5003	1	1/4" 3/8"	Macho Macho	70	5,24 5,01
PM5012 PM5013	1	1/4" 3/8"	Hembra Hembra	80	5,40 10,10
PM5142 PM5143	1	1/4" 3/8"	Macho Macho	20	1,93 1,57
PM5152 PM5153	1	1/4" 3/8"	Hembra Hembra	20	1,02 1,57
PM5248	1	-	Para tubos de 8 mm	10	1,77

LUBRICADOR



• Instalar en la máquina o en tubo con conector rápido con rosca de 1/4"

Modelo	Caja	Tamaño (inch)	Peso (kg)	Precio (€)
PN251	1	1/4"	0.10	13,43

188



REGULADORES - FILTROS



- Cuando se comprime el aire atmosférico, que siempre contiene cierta humedad, se genera agua en el circuito neumático. Por ello, es necesario filtrar esta agua para proteger el propio circuito y, sobre todo, las máquinas neumáticas
- Usar regulador y filtro de aire para pistolas de pintura
- Datos técnicos:
 - Conexión de aire 1/2"
 - Capacidad cubeta 100 ml
 - Ø del manómetro 50 mm
 - Gama de regulación 0,5-10 bar
 - Temp. mínima +5°
 - Temp. máxima 60°
 - Caudal nominal 3.200 NL/mn
 - Filtrado 20 m

R	📦	kg	€
P254	1	1.04	47,69

REGULADORES - FILTROS - LUBRICADORES



- Cuando se comprime el aire atmosférico, que siempre contiene cierta humedad, se genera agua en el circuito neumático. Por ello, es necesario filtrar esta agua para proteger el propio circuito y, sobre todo, las máquinas neumáticas
- Para el resto de máquinas neumáticas, usar regulador, filtro y lubricador
- Datos técnicos:
 - Conexión de aire 1/2"
 - Capacidad cubeta 100 ml
 - Ø del manómetro 50 mm
 - Gama de regulación 0,5-10 bar
 - Temp. mínima +5°
 - Temp. máxima 60°
 - Caudal nominal 3.200 NL/mn
 - Filtrado 20 m

R	📦	kg	€
P255	1	1.42	80,01

ATORNILLADOR A BATERÍA

ATORNILLADOR 1/4" A BATERÍA



- Batería recargable de Litio 3.6V
- Porta puntas cambio rápido 1/4"
- Apriete suave ajustable 6 posiciones+1 reverso
- Tiempo de carga. 3-5 horas
- Indicador de carga LED
- 4 puntas 1/4" incluidas
- 200 rpm
- Par máximo 3,0 Nm
- Embalaje en caja de cartón

R	📦	V	📏	RPM	g	€
3.6SDR	1	3.6	95x65x35	200	400	45,52





Estas son algunas de las ventajas de las que podrá disfrutar con nuestro material para el punto de venta:

- Los expositores IRIMO son una perfecta solución que contribuye a mejorar la gestión en el punto de venta.
- Gracias a su atractivo diseño, ayudan a potenciar la imagen del resto de la tienda.
- Facilitan el control del stock y a la par optimizan el espacio de exposición.

NOTA: A continuación se exponen algunos ejemplos; para más información acerca de diferentes accesorios y tamaños, no dude en consultarnos y le ofreceremos la solución ideal y ajustada a sus necesidades.

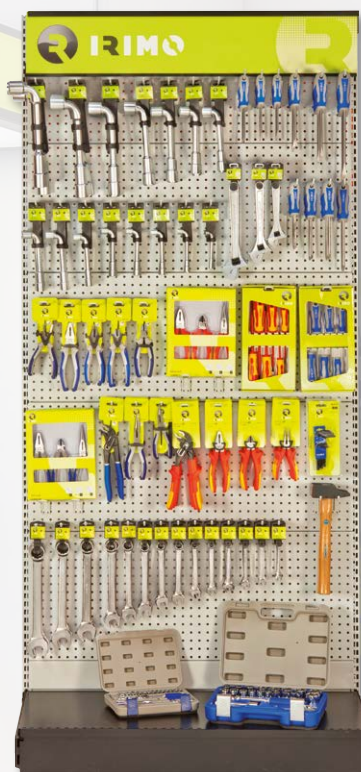

IRIMO		€
MEE-SIGN-CARR-I	CABECERO IRIMO (100 cm)	-
MEE-1S2L-B-I	EXPOSITOR 2 PATAS	-

* Herramienta no incluida

MATERIAL DE PUNTO DE VENTA

EXPOSITOR 2 PATAS

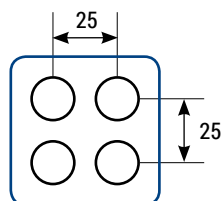

Detalle pared perforada

R	W mm	H mm	L mm	kg	€
MEE-1S2L-B-I	524	2250	1030	53.63	-

CABECERO LUMINOSO



- Cable corto incluido
- Cable largo a pedir a parte (PEE-LCABLE-B-I)

R	W mm	H mm	L mm	kg	€
MEE-LIGHTBOX-I	412	170	1000	13.32	-

CABECERO



R	W mm	H mm	L mm	kg	€
MEE-SIGN-CARR-I	90	200	1000	1.98	-

EXPOSITOR DE ESQUINA 1 PATA

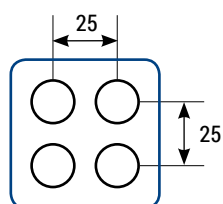
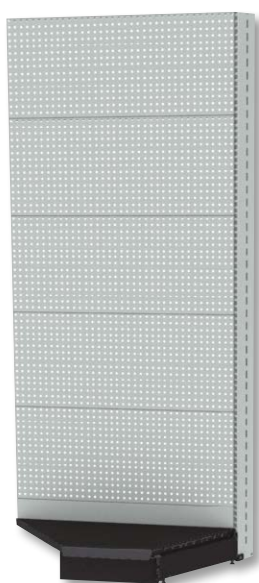

Detalle pared perforada

R	W mm	H mm	L mm	kg	€
MEE-COR-1L-B-I	388	2350	941	44.05	-

CABECERO LUMINOSO ESQUINA



- Cable corto incluido
- Cable largo a pedir a parte (PEE-LCABLE-B-I)

R	W mm	H mm	L mm	kg	€
MEE-COR-LIGHT-I	400	174	910	7.375	-

MATERIAL DE PUNTO DE VENTA

PIEZAS PARA EXPOSITOR DE PARED

METACRILATO PARA CABECERO LUMINOSO



IRIMO	W mm	H mm	L mm	kg	€
PEE-METHACRYL-I	3	168	980	0.61	-

METACRILATO PARA CABECERO



IRIMO	W mm	H mm	L mm	kg	€
PEE-SIGN-DB-W-2	3	150	980	0.2	-

METACRILATO PARA EXPOSITOR PARED DOBLE



IRIMO	W mm	H mm	L mm	kg	€
PEE-TOPSIGN-I	3	150	980	0.2	-

EXPOSITOR DOBLE PARED CON RUEDAS

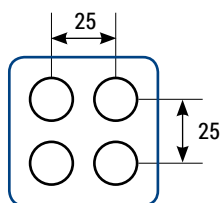
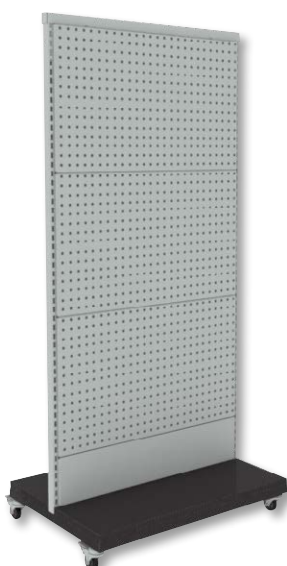

Detalle pared perforada

IRIMO	W mm	H mm	L mm	kg	€
MEE-DB-W-NL	300	800	1390	29.99	-

BANNER PARA EXPOSITOR DE PARED



IRIMO	W mm	H mm	L mm	kg	€
MEE-BANNER-I	15	1200	230	1.025	-

EXPOSITOR TRIANGULAR CON RUEDAS

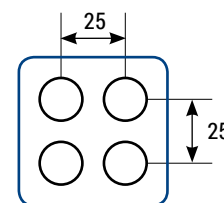
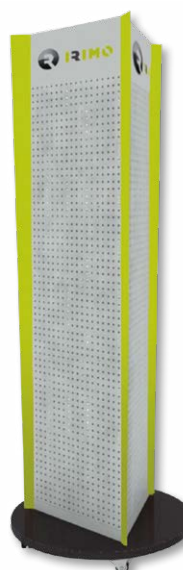

Detalle pared perforada

IRIMO	W mm	H mm	L mm	kg	€
MEE-TR-W-I	700	1860	700	23.45	-

MATERIAL DE PUNTO DE VENTA

EXPOSITOR GENÉRICO



R	W mm	H mm	L mm	kg	€
MEE-COUNT-IR-1	295	615	430	6.7	-

EXPOSITOR GENÉRICO



- El expositor incluye 12 ganchos de 240 mm cada uno

R	W mm	H mm	L mm	kg	€
MEE-COUNT-IR-2	260	465	465	2.6	-

EXPOSITOR GENÉRICO



- El expositor incluye 22 ganchos de 240 mm cada uno

R	W mm	H mm	L mm	kg	€
MEE-COUNT-IR-3	270	465	775	4.12	-

CUBRE PALET PARA EURO PALET



R	W mm	H mm	L mm	kg	€
PEE-PC-IR-1	1150	250	800	0.735	-

DISPLAY PARA ALICATES, 20 piezas



R	W mm	H mm	L mm	kg	€
PEE-COUNT-006	280	240	365	0.23	-

DISPLAY CARTÓN 5 ALICATES



R	W mm	H mm	L mm	kg	€
CEE-COUNT-IR-1	200	60	90	0.237	-

HOJA A4 CON PEGATINAS



R	W mm	L mm	kg	€
PPOS-A4-STICK-1	210	295	0.018	-

EXPOSITOR



- Material: Metal y plástico
- Color: Negro y verde
- Con tres baldas para distintos tamaños de juegos de vasos:
 - Pequeños: 109-35-4
 - Medianos: 119-18-4 o 129-23-4
 - Grandes: 129-58-4 o 129-101-4
- Se entrega vacío

R	W mm	H mm	L mm	kg	€
MEE-SA-SS-IR	1	1835	455x380	-	-

€	📖	€
001021	36	27,40
001031	36	31,24
001041	36	37,07
001051	36	47,37
001061	36	79,28
001071	36	150,69
001081	36	294,45
020011	44	7,96
020031	44	8,23
020051	44	9,15
020071	44	9,99
020091	44	10,96
020121	44	11,78
020141	44	12,25
020171	44	14,14
020181	44	15,49
020201	44	17,38
020211	44	17,38
020221	44	19,64
020241	44	23,46
020251	44	24,76
021221	44	91,45
021251	44	168,59
040001	112	0,46
040011	112	0,47
040021	112	0,56
040031	112	0,62
040041	112	0,76
040051	112	0,87
040061	112	1,05
040071	112	1,43
040081	112	1,96
040091	112	2,17
040101	112	2,75
040121	112	4,02
040141	112	5,42
040171	112	7,65
040191	112	12,93
040221	112	19,14
040541	112	0,51
040561	112	0,67
040581	112	0,76
040601	112	1,09
040611	112	1,32
040621	112	1,62
040641	112	2,02
040661	112	2,83
040681	112	3,45
040701	112	4,21
040731	112	7,08
041011	112	7,15
041021	112	15,70
041031	112	43,12
041041	112	8,78
041051	112	21,29
041061	112	45,86
041071	112	11,95
041091	112	21,04

€	📖	€
041101	112	67,50
041111	113	9,74
041121	113	14,21
045001	113	0,46
045011	113-115	0,46
045021	113	0,53
045031	113	0,62
045041	113-115	0,63
045051	113	0,91
045061	113	1,11
045071	113	1,52
045081	113	1,73
045091	113	2,34
045101	113	2,43
045121	113	3,58
045141	113	5,03
045171	113	8,07
045191	113-115	11,35
045221	113	18,15
045541	115	0,47
045561	115	0,40
045581	115	0,47
045601	115	0,66
045611	115	0,89
045621	115	1,46
045641	115	1,75
045661	115	2,41
045681	115	3,04
045701	115	3,70
045731	115	6,23
045801	115	0,51
045811	115	0,54
045821	115	0,58
045831	115	0,72
045841	115	0,83
045851	115	1,05
045861	115	1,78
045871	115	2,63
045881	115	3,05
045891	115	3,83
045901	115	4,44
045921	115	6,48
045941	115	8,29
046011	114	6,18
046021	114	15,12
046031	114	39,78
046041	115	8,09
046051	115	19,25
046061	115	41,19
046091	114	18,59
046101	114	62,65
047001	116	1,23
047011	116	1,40
047021	116	1,46
047031	116	1,52
047041	116	1,82
047051	116	2,21
047061	116	3,37

€	📖	€
047081	116	4,74
047101	116	8,51
047121	116	9,10
055011	47	11,47
055031	47	11,60
055051	47	12,39
055071	47	14,55
055091	47	16,38
055121	47	19,28
055141	47	22,68
055171	47	25,84
055181	47	28,71
055201	47	30,68
055211	47	31,20
055221	47	35,41
055241	47	40,37
055251	47	44,99
055301	47	9,91
055311	47	13,84
056231	47	138,99
056271	47	280,58
066-400-1	167	34,47
070411	52	148,82
070421	52	148,82
070431	52	153,97
070441	52	161,66
070451	52	177,06
070461	52	184,75
070471	52	642,70
070481	52	1.280,81
10-0405-1	37	2,78
10-0607-1	37	2,78
10-0809-1	37	2,85
10-1011-1	37	3,08
10-1013-1	37	3,75
10-12-H	38	67,83
10-12-W	38	71,77
10-1213-1	37	3,77
10-1415-1	37	3,98
10-1617-1	37	4,61
10-1719-1	37	5,20
10-1819-1	37	5,20
10-2022-1	37	6,10
10-2123-1	37	6,66
10-2224-1	37	6,71
10-2426-1	37	8,23
10-2427-1	37	8,85
10-2528-1	37	11,24
10-2729-1	37	12,19
10-3032-1	37	13,40
10-8-H	38	32,64
101-04-1	56	3,55
101-045-1	56	3,55
101-05-1	56	3,55
101-055-1	56	3,55
101-06-1	56	3,55
101-07-1	56	3,55
101-08-1	56	3,55

🔍	📖	€
101-09-1	56	3,55
101-10-1	56	3,55
101-11-1	56	3,55
101-12-1	56	3,55
101-13-1	56	3,55
101-14-1	56	3,55
101A-05-1	56	3,62
101A-06-1	56	3,62
101A-07-1	56	3,62
101A-08-1	56	3,62
101A-09-1	56	3,62
101A-10-1	56	3,62
101A-11-1	56	3,62
101A-12-1	56	3,62
101A-14-1	56	3,62
101A-16-1	56	3,62
101A-18-1	56	3,62
103-04-1	56	8,37
103-045-1	56	8,37
103-05-1	56	8,37
103-055-1	56	8,37
103-06-1	56	8,37
103-07-1	56	8,37
103-08-1	56	8,37
103-09-1	56	8,37
103-10-1	56	8,37
103-11-1	56	8,37
103-12-1	56	8,37
103-13-1	56	8,37
103-14-1	56	8,37
103A-06-1	56	8,53
103A-08-1	56	8,53
103A-09-1	56	8,53
103A-10-1	56	8,53
103A-11-1	56	8,53
103A-12-1	56	8,53
103A-14-1	56	8,53
103A-16-1	56	8,53
105-22-1	59	4,02
105-24-1	59	5,46
105-26-1	59	5,77
105-28-1	59	9,13
105-40-1	59	10,31
105-42-1	59	7,05
105-46-1	59	5,46
105-48-1	59	4,24
105-50-1	59	8,01
105-70-1	58	12,77
105-70-12DISP	58	153,24
105501	58	31,66
106-04-1	56	3,79
106-05-1	56	3,79
106-06-1	56	3,79
106-07-1	56	3,79
106-08-1	56	3,79
106-10-1	56	3,79
107-0840-1	57	3,23
107-1055-1	57	3,23

🔍	📖	€
107-1280-1	57	3,23
107-H3-1	57	3,09
107-H4-1	57	3,09
107-H5-1	57	3,09
107-H6-1	57	3,09
107-H8-1	57	3,09
107-PH1-1	57	3,36
107-PH2-1	57	3,36
107-PH3-1	57	3,36
107-PZ1-1	57	3,36
107-PZ2-1	57	3,36
107-PZ3-1	57	3,36
107-T08-1	57	4,01
107-T09-1	57	4,01
107-T10-1	57	4,01
107-T15-1	57	4,01
107-T20-1	57	4,01
107-T25-1	57	4,13
107-T27-1	57	4,13
107-T30-1	57	4,13
107-T40-1	57	4,13
107A-4-1	57	3,13
107A-5-1	57	3,13
107A-6-1	57	3,13
107A-7-1	57	3,13
109-11-4	58	41,28
109-13-4	58	31,27
109-19-4	61	37,11
109-23-4	60	31,19
109-35-4	60	37,95
109-37-4	60	36,05
112-06-1	61	2,17
112-07-1	61	2,17
112-08-1	61	2,17
112-09-1	61	2,17
112-10-1	61	2,17
112-11-1	61	2,17
112-12-1	61	2,17
112-13-1	61	2,39
112-14-1	61	2,39
112-15-1	61	2,39
112-16-1	61	2,81
112-17-1	61	2,81
112-18-1	61	3,09
112-19-1	61	3,09
112-20-1	61	3,09
112-21-1	61	3,36
112-22-1	61	3,36
113-07-1	61	6,74
113-08-1	61	6,74
113-09-1	61	6,74
113-10-1	61	6,74
113-11-1	61	6,74
113-12-1	61	7,15
113-13-1	61	7,15
113-14-1	61	7,15
113-16-1	61	7,15
113-17-1	61	8,42

🔍	📖	€
113-19-1	61	8,42
115-20-1	62	4,23
115-22-1	62	5,77
115-24-1	62	6,10
115-40-1	63	10,90
115-42-1	62	7,45
115-43-1	62	5,46
115-44-1	63	7,45
115-46-1	63	5,77
115-48-1	63	4,48
115-70-1	62	15,33
115501	62	46,26
119-18-4	63	47,15
121-08-1	64	3,60
121-09-1	64	3,60
121-10-1	64	3,56
121-11-1	64	3,63
121-12-1	64	3,89
121-13-1	64	4,05
121-14-1	64	4,29
121-15-1	64	4,36
121-16-1	64	4,54
121-17-1	64	4,66
121-18-1	64	4,66
121-19-1	64	4,90
121-20-1	64	4,98
121-21-1	64	5,16
121-22-1	64	5,34
121-23-1	64	5,57
121-24-1	64	5,93
121-25-1	64	6,02
121-26-1	64	6,16
121-27-1	64	6,42
121-28-1	64	6,81
121-30-1	64	7,12
121-32-1	64	7,31
121-34-1	64	9,44
121-36-1	64	13,28
122-08-1	64	3,60
122-09-1	64	3,60
122-10-1	64	3,56
122-11-1	64	3,63
122-12-1	64	3,89
122-13-1	64	4,05
122-14-1	64	4,29
122-15-1	64	4,36
122-16-1	64	4,54
122-17-1	64	4,66
122-18-1	64	4,66
122-19-1	64	4,90
122-20-1	64	4,98
122-21-1	64	5,16
122-22-1	64	5,34
122-23-1	64	5,57
122-24-1	64	5,93
122-27-1	64	6,42
122-30-1	64	7,12
122-32-1	64	7,31

€	📖	€
122-34-1	64	15,24
122-36-1	64	16,94
122A-10-1	64	3,63
122A-11-1	64	3,65
122A-12-1	64	3,68
122A-14-1	64	3,79
122A-16-1	64	4,14
122A-18-1	64	4,39
122A-20-1	64	4,66
122A-22-1	64	4,85
122A-24-1	64	5,06
122A-26-1	64	5,30
122A-28-1	64	5,52
122A-30-1	64	6,16
122A-34-1	64	6,63
122A-38-1	64	7,34
122A-40-1	64	7,52
123-10-1	65	9,88
123-12-1	65	9,96
123-13-1	65	10,15
123-14-1	65	10,76
123-15-1	65	10,76
123-16-1	65	10,76
123-17-1	65	10,76
123-18-1	65	10,76
123-19-1	65	10,76
123-21-1	65	11,03
123-22-1	65	15,48
123-24-1	65	15,56
124-10-1	65	9,88
124-11-1	65	9,96
124-12-1	65	9,96
124-13-1	65	10,14
124-14-1	65	10,77
124-15-1	65	10,77
124-16-1	65	10,77
124-17-1	65	10,77
124-18-1	65	10,77
124-19-1	65	10,77
124-21-1	65	11,03
124-22-1	65	15,48
124-24-1	65	15,56
124-27-1	65	15,84
124-30-1	65	17,15
124-32-1	65	20,37
124A-18-1	65	10,98
124A-20-1	65	10,98
124A-22-1	65	11,20
124A-24-1	65	15,79
124A-26-1	65	15,88
125-22-1	68	7,97
125-23-1	68	8,37
125-25-1	68	10,31
125-40-1	70	17,80
125-42-1	69	13,80
125-43-1	69	6,55
125-44-1	69	11,38
125-46-1	69	9,43

€	📖	€
125-48-1	70	6,00
125-49-1	69	19,03
125-52-1	68	27,39
125-53-1	69	9,14
125-54-1	69	11,49
125-60-1	69	10,14
125-70-1	67	17,96
125-70-12DISP	68	215,61
125501	67	52,26
126-10-1	65	5,64
126-11-1	65	5,64
126-12-1	65	5,82
126-14-1	65	5,82
126-16-1	65	5,93
126-18-1	65	5,93
126-20-1	65	6,16
126-24-1	65	6,85
129-10-4	68	43,68
129-101-4	73	132,40
129-108-4	72	149,24
129-12-4	68	43,26
129-172-4	73	212,80
129-23-4	70	81,32
129-33W-4	70	108,93
129-58-4	71	105,30
129-9H-4	66	43,58
129-9T-4	66	44,68
129A-103-4	72	151,55
129A-53-4	71	105,55
131-19-1	74	10,34
131-21-1	74	10,49
131-22-1	74	10,64
131-23-1	74	11,01
131-24-1	74	11,40
131-25-1	74	11,40
131-26-1	74	11,79
131-27-1	74	11,79
131-28-1	74	12,36
131-29-1	74	12,74
131-30-1	74	13,21
131-32-1	74	13,51
131-33-1	74	14,18
131-34-1	74	14,48
131-35-1	74	14,74
131-36-1	74	15,61
131-38-1	74	16,87
131-40-1	74	17,82
131-41-1	74	18,60
131-42-1	74	19,72
131-46-1	74	21,94
131-50-1	74	24,99
131-55-1	74	30,08
131-60-1	74	33,44
131B-19-2	75	10,34
131B-21-2	75	10,49
131B-22-2	75	10,64
131B-23-2	75	11,01
131B-24-2	75	11,40

€	📖	€
131B-26-2	75	11,79
131B-27-2	75	11,79
131B-29-2	75	12,74
131B-30-2	75	13,21
131B-32-2	75	13,51
131B-35-2	75	14,74
131B-36-2	75	15,61
131B-38-2	75	16,87
131B-41-2	75	18,60
131B-46-2	75	21,94
131B-50-2	75	24,99
132A-28-1	75	10,92
132A-30-1	75	11,49
132A-32-1	75	11,59
132A-34-1	75	11,97
132A-36-1	75	12,55
132A-40-1	75	13,89
132A-42-1	75	15,03
132A-44-1	75	15,33
132A-46-1	75	15,90
132A-48-1	75	17,24
132A-52-1	75	18,88
132A-54-1	75	20,03
132A-60-1	75	25,67
132A-64-1	75	25,67
135-21-1	75	18,76
135-22-1	75	22,03
135-24-1	75	29,41
135-40-1	76	49,33
135-42-1	75	33,82
135-43-1	76	13,21
135-46-1	76	15,82
135-52-1	76	41,48
135-70-1	75	69,12
135-85-1	75	14,79
139-17-4	76	207,82
139-21-4	76	242,70
139-21B-4	77	242,70
1467-A01	159	28,24
149-164-4	74	314,32
15-0607-1	45	5,55
15-0809-1	45	6,08
15-1011-1	45	6,45
15-12-W	45	136,36
15-1213-1	45	6,93
15-1415-1	45	7,34
15-1617-1	45	8,76
15-1719-1	45	10,22
15-1819-1	45	10,22
15-2022-1	45	11,75
15-2123-1	45	13,37
15-2426-1	45	16,54
15-2427-1	45	16,79
15-2528-1	45	19,29
15-2729-1	45	21,40
15-3032-1	45	23,52
15-3236-2	45	37,44
15-3641-2	45	46,84

€	📖	€
15-8-H	45	63,09
15-8-W	45	66,40
160-07-1	77	2,52
160-08-1	77	2,52
160-10-1	77	2,52
160-11-1	77	2,52
160-12-1	77	2,52
160-13-1	77	2,77
160-14-1	77	2,77
160-15-1	77	2,77
160-16-1	77	3,26
160-17-1	77	3,26
160-18-1	77	3,58
160-19-1	77	3,58
160-20-1	77	3,58
160-21-1	77	3,91
160-24-1	77	4,67
161-10-1	77	7,82
161-13-1	77	8,30
161-17-1	77	9,77
162-00-1	78	4,93
162-02-1	78	6,69
162-50-1	78	12,66
162-60-1	78	8,65
162-65-1	78	6,69
162931	78	4,93
162941	78	4,93
167-08-1	79	4,17
167-10-1	79	4,14
167-10-4	79	36,41
167-11-4	80	54,59
167-12-1	79	4,51
167-13-1	79	4,71
167-14-1	79	4,95
167-15-1	79	5,05
167-16-1	79	5,27
167-17-1	79	5,42
167-18-1	79	5,42
167-19-1	79	5,69
167-20-1	79	5,78
167-21-1	79	5,99
167-22-1	79	6,19
167-23-1	79	6,48
167-24-1	79	6,89
167-26-1	79	7,16
167-27-1	79	7,45
167-30-1	79	8,26
167-32-1	79	8,48
167-34-1	79	10,12
167-36-1	79	10,43
167-38-1	79	13,29
167-41-1	79	13,89
167-9-4	79	56,65
168-10-1	80	11,47
168-11-1	80	11,56
168-13-1	80	11,79
168-14-1	80	12,50
168-14-4	80	113,82

€	📖	€
168-16-1	80	12,50
168-17-1	80	12,50
168-18-1	80	12,50
168-19-1	80	12,50
168-21-1	80	12,79
168-22-1	80	17,97
168-23-1	80	18,02
168-24-1	80	18,07
168-27-1	80	18,40
168-30-1	80	19,92
168-32-1	80	22,15
168-7-4	80	53,46
169-01-1	81	9,71
169-02-1	81	11,99
169-03-1	81	9,23
169-25-1	81	20,66
169-60-1	81	13,21
169-65-1	81	10,96
169921	81	4,95
169931	81	4,95
173-01-5	82	125,58
173-17-2	82	11,38
173-18-2	82	11,69
173-19-2	82	12,01
173-21-2	82	12,19
173-22-2	82	12,36
173-23-2	82	12,78
173-24-2	82	13,24
173-27-2	82	13,68
173-28-2	82	14,34
173-29-2	82	14,80
173-30-2	82	15,34
173-32-2	82	15,68
173-33-2	82	16,48
173-34-2	82	16,79
173-36-2	82	18,13
173-38-2	82	19,58
173-41-2	82	21,60
173-46-2	82	25,47
173-50-2	82	29,04
173-55-2	82	34,91
173-60-2	82	38,83
174-17-2	82	19,63
174-19-2	82	20,70
174-21-2	82	21,02
174-22-2	82	21,31
174-24-2	82	22,84
174-27-2	82	23,58
174-30-2	82	27,92
174-32-2	82	28,52
174-33-2	82	29,96
174-34-2	82	32,30
174-36-2	82	34,84
174-41-2	82	41,49
175-01-2	83	21,79
175-02-2	83	34,15
175-10-2	83	25,59
175-25-2	82	57,27

€	📖	€
175-60-2	83	30,97
175-65-2	83	18,35
175911	82	5,62
177-10-5	83	161,63
177-22-2	83	19,18
177-24-2	83	20,55
177-27-2	83	21,23
177-30-2	83	22,98
177-32-2	83	23,47
177-33-2	83	24,66
177-34-2	83	21,72
177-36-2	83	26,00
177-38-2	83	28,10
177-41-2	83	32,55
177-42-2	83	32,87
177-46-2	83	34,77
177-50-2	83	44,25
177-55-2	83	50,52
177-60-2	83	60,13
177-65-2	83	67,63
177-70-2	83	73,94
177-75-2	83	81,53
177-80-2	83	96,08
178-22-2	84	24,92
178-24-2	84	26,70
178-27-2	84	27,58
178-30-2	84	28,29
178-32-2	84	28,89
178-33-2	84	31,66
178-34-2	84	27,87
178-36-2	84	31,31
178-38-2	84	33,82
178-41-2	84	42,10
178-46-2	84	33,64
178-50-2	84	42,90
178-55-2	84	54,16
178-60-2	84	62,62
179-00-2	84	81,35
179-01-2	84	87,61
179-02-2	84	102,13
179-52-2	84	193,55
179-65-2	84	19,16
179931	82-84	6,35
179941	84	8,37
18-06-1	41	7,55
18-07-1	41	7,55
18-08-1	41	7,55
18-09-1	41	7,73
18-10-1	41	7,73
18-11-1	41	8,18
18-12-1	41	8,56
18-12-H	42	117,06
18-13-1	41	9,62
18-14-1	41	10,32
18-15-1	41	10,76
18-16-1	41	11,77
18-17-1	41	12,58
18-18-1	41	13,21

€	📖	€
18-19-1	41	13,77
18-21-1	41	16,67
18-22-1	41	18,22
18-24-1	41	20,73
18-27-1	41	27,25
18-30-1	41	32,16
18-32-1	41	41,47
18-8-H	41	77,38
180-04-1	66	8,89
180-05-1	66	8,89
180-05X-1	66	9,88
180-06-1	66	8,89
180-06X-1	66	9,88
180-07-1	66	9,25
180-07X-1	66	10,14
180-08-1	66	9,25
180-08X-1	66	10,14
180-10-1	66	9,25
180-10X-1	66	10,14
180-12-1	66	10,14
180-12X-1	66	12,00
180-14-1	66	10,14
180-17-1	66	12,00
180-19-1	66	17,20
183-20-1	66	9,53
183-25-1	66	9,53
183-27-1	66	9,53
183-30-1	66	9,53
183-40-1	66	9,60
183-40X-1	66	10,49
183-45-1	66	9,60
183-45X-1	66	10,49
183-50-1	66	9,60
183-50X-1	66	10,49
183-55-1	66	12,18
183-55X-1	66	17,36
183-60-1	66	12,55
185-05-1	67	11,03
185-06-1	67	11,03
185-06X-1	67	11,21
185-08-1	67	11,03
185-08X-1	67	11,21
185-10-1	67	11,21
185-10X-1	67	12,00
185-12-1	67	12,00
185-12X-1	67	13,70
185-14-1	67	12,00
185-16-1	67	14,32
18D-5-H	42	52,17
18S-08-1	42	5,73
18S-10-1	42	5,90
18S-13-1	42	7,21
18S-17-1	42	9,33
18S-19-1	42	10,40
18S-5-H	42	38,60
19-08-1	43	9,62
19-10-1	43	9,88
19-11-1	43	10,39

€	📖	€
19-12-1	43	10,82
19-12-H	43	144,31
19-13-1	43	12,21
19-14-1	43	13,21
19-17-1	43	15,98
19-19-1	43	17,49
19-8-H	43	99,40
190-10-135	103	17,91
190-6-135	103	17,91
190-7-135	103	17,91
190-8-135	103	17,91
191-10-175	109	12,91
191-12-175	109	14,31
191-13-175	109	15,25
191-6-150	109	11,06
191-7-175	109	11,96
191-8-175	109	12,17
201231	86	224,47
201241	86	299,26
201251	86	412,19
201261	86	585,85
201431	89	58,58
201451	89	89,39
201461	89	103,29
201471	89	134,09
202-100	87	19,42
202-125	87	23,99
202-150	87	27,51
202401	87	23,07
202411	87	23,63
202421	87	34,94
202431	87	34,94
202441	87	23,63
202451	87	42,77
202461	87	50,95
202511	88	34,06
202521	88	35,50
202541	88	36,79
202561	88	34,32
202571	88	35,64
202581	88	37,11
202661	89	40,34
202671	89	42,14
202681	89	43,27
202761	89	39,19
202771	89	40,34
202781	89	41,95
202811	88	45,25
202821	88	73,38
202831	88	53,83
202841	88	124,81
206-100	88	21,46
206-125	88	25,98
206-150	88	28,98
206721	87	31,53
206741	87	39,16
206761	87	39,16
206821	88	41,46

€	📖	€
206831	88	59,00
206841	88	105,47
206851	88	135,68
207-100	87	150,92
207-125	87	226,38
207-150	87	295,55
207041	86	232,92
207051	86	326,08
207061	86	419,25
207071	86	558,99
216041	86	273,71
216051	86	367,80
216061	86	464,75
216071	86	604,44
217-50-B	89	37,35
25-06-1	39	2,84
25-06-2	39	2,84
25-07-1	39	2,89
25-07-2	39	2,89
25-08-1	39	2,96
25-08-2	39	2,96
25-09-1	39	3,52
25-09-2	39	3,52
25-10-1	39	3,54
25-10-2	39	3,54
25-100-2	39	741,07
25-11-1	39	3,87
25-11-2	39	3,87
25-12-1	39	4,08
25-12-2	39	4,08
25-12-H	40	88,22
25-12-W	41	117,17
25-13-1	39	4,32
25-13-2	39	3,85
25-14-1	39	4,49
25-14-2	39	3,99
25-15-1	39	4,62
25-15-2	39	4,15
25-16-1	39	4,91
25-16-2	39	4,42
25-17-1	39	5,24
25-17-2	39	4,77
25-18-1	39	5,52
25-18-2	39	5,04
25-19-1	39	6,30
25-19-2	39	5,83
25-20-1	39	6,37
25-20-2	39	5,89
25-21-1	39	7,29
25-21-2	39	6,81
25-22-1	39	7,35
25-22-2	39	6,88
25-23-1	39	7,77
25-23-2	39	7,30
25-24-1	39	8,14
25-24-2	39	7,67
25-25-1	39	8,83
25-25-2	39	8,33

€	📖	€
25-26-1	39	10,48
25-26-2	39	10,01
25-27-1	39	11,59
25-27-2	39	11,09
25-28-1	39	12,32
25-28-2	39	11,83
25-29-1	39	12,63
25-29-2	39	12,14
25-30-1	39	14,03
25-30-2	39	13,55
25-32-1	39	15,13
25-32-2	39	14,66
25-34-1	39	18,98
25-34-2	39	18,51
25-36-2	39	28,28
25-41-2	39	39,64
25-46-2	39	51,17
25-50-2	39	59,53
25-55-2	39	133,98
25-60-2	39	177,90
25-65-2	39	237,05
25-70-2	39	281,87
25-75-2	39	355,35
25-8-H	40	37,69
25-80-2	39	480,21
25-85-2	39	598,78
25-90-2	39	598,78
25-95-2	39	598,78
254-1200-2	91	15,67
254-150-2	91	8,06
254-300-2	91	9,02
254-450-2	91	10,76
254-600-2	91	12,08
254-900-2	91	15,62
255011	90	11,92
255021	90	12,63
255031	90	13,61
255041	90	14,52
255051	90	15,78
256001	90	19,74
256011	90	21,21
256031	90	23,88
256041	90	26,27
256131	90	25,70
256141	90	27,84
256151	90	30,35
256161	90	32,35
256181	90	37,13
256201	90	42,18
256231	90	46,01
256241	90	49,06
256251	90	51,88
256261	90	54,28
256281	90	59,52
256301	90	64,07
256321	90	67,99
257-200-2	91	61,66
257-300-2	91	65,21

€	📖	€
257-400-2	91	68,02
257-500-2	91	72,21
257-600-2	91	75,64
258-100-2	90	12,45
258-120-2	90	13,04
258-160-2	90	16,06
258-200-2	90	27,92
258-250-2	90	28,75
258-300-2	90	29,65
25A-08-1	40	2,92
25A-08-2	40	2,43
25A-10-1	40	3,02
25A-10-2	40	2,54
25A-12-1	40	3,58
25A-12-2	40	3,11
25A-14-1	40	3,98
25A-14-2	40	3,51
25A-16-1	40	4,41
25A-16-2	40	3,94
25A-18-1	40	4,60
25A-18-2	40	4,12
25A-20-1	40	5,03
25A-20-2	40	4,55
25A-22-1	40	5,34
25A-22-2	40	4,85
25A-24-1	40	6,37
25A-24-2	40	5,89
25A-26-1	40	7,43
25A-26-2	40	6,94
25A-28-1	40	7,53
25A-28-2	40	7,06
25A-30-1	40	8,39
25A-30-2	40	7,91
25A-32-1	40	9,06
25A-32-2	40	8,58
25A-34-1	40	11,77
25A-36-1	40	12,55
25A-40-1	40	15,39
25A-44-1	40	28,20
25A-46-1	40	28,65
25A-48-1	40	29,10
25A-52-1	40	40,61
25A-58-1	40	68,75
25A-64-1	40	79,67
29-3550-2	49	24,08
29-5080-2	49	32,83
29-80120-2	49	45,93
29P-3550-2	49	26,27
29P-3550-A	49	5,21
29P-5080-2	49	35,69
29P-5080-A	49	5,91
29P-80120-2	49	49,85
29P-80120-A	49	6,49
3.6SDR	189	45,52
30-100-2	48	299,47
30-24-2	48	32,69
30-27-2	48	35,56
30-30-2	48	36,63

€	📖	€
30-32-2	48	36,63
30-34-2	48	41,51
30-36-2	48	46,76
30-38-2	48	55,03
30-41-2	48	51,86
30-46-2	48	65,44
30-50-2	48	73,57
30-55-2	48	84,14
30-60-2	48	88,71
30-65-2	48	92,21
30-70-2	48	96,22
30-75-2	48	103,34
30-80-2	48	137,47
30-85-2	48	184,09
30-90-2	48	240,68
30-95-2	48	265,93
302-210-2	94	16,06
302-260-2	94	17,86
302-310-2	94	20,83
302-365-2	94	22,33
302-465-2	94	31,25
302-615-2	94	51,93
302-900-2	94	99,96
302S-210-2	94	11,82
302S-260-2	94	16,41
302S-310-2	94	18,12
302S-365-2	94	18,25
302S-465-2	94	28,58
302S-615-2	94	40,02
302S-900-2	94	71,47
302T-210-2	94	9,86
302T-260-2	94	9,27
302T-310-2	94	9,32
302T-365-2	94	9,57
302T-465-2	94	9,98
302T-615-2	94	15,91
302T-900-2	94	24,64
303081	95	27,66
303111	95	35,87
303121	95	49,01
303131	95	76,45
303171	95	131,48
303201	95	35,46
303211	95	48,39
303221	95	75,31
303231	95	113,59
303241	95	212,16
303291	95	38,39
303301	95	45,87
303311	95	58,28
303321	95	87,12
303331	95	214,88
304-250-2	94	24,91
304-350-2	94	33,11
304-450-2	94	47,28
304-600-2	94	78,80
304-900-2	94	152,42
304F-250-2	94	14,29

€	📖	€
304F-350-2	94	14,99
304F-450-2	94	17,42
304F-600-2	94	20,28
304F-900-2	94	31,44
304S-250-2	94	15,76
304S-350-2	94	20,14
304S-450-2	94	29,28
304S-600-2	94	43,47
304S-900-2	94	81,60
304T-250-2	94	6,41
304T-350-2	94	7,65
304T-450-2	94	10,28
304T-600-2	94	14,32
304T-900-2	94	25,37
307-1122-2	95	408,40
307-350-2	95	100,25
307-685-2	95	185,50
307-940-2	95	236,49
307S-1122-2	95	177,94
307S-350-2	95	38,36
307S-685-2	95	53,52
307S-940-2	95	84,16
31-30-2	48	21,40
31-32-2	48	22,71
31-36-2	48	29,25
31-41-2	48	35,87
31-46-2	48	48,31
31-50-2	48	55,03
31-55-2	48	64,19
31-60-2	48	76,43
31-65-2	48	95,77
31-70-2	48	115,16
31-75-2	48	123,31
31-80-2	48	172,53
31-85-2	48	205,43
321-42-1	96	59,85
321-BLADE-1	96	18,74
321161	96	14,99
321171	96	18,38
321281	96	18,93
321361	96	48,62
321501	96	124,34
321511	96	5,23
321551	96	8,53
330021	97	26,76
332-51-4	97	90,68
332-52-4	97	164,42
332S-030-2	97	12,78
333-003-2	97	12,78
333-004-2	97	12,78
333-006-2	97	12,78
333-008-2	97	12,78
333-010-2	97	12,78
333-012-2	97	19,00
333-014-2	97	19,00
333-016-2	97	19,00
333-018-2	97	19,00
333-020-2	97	19,00

€	📖	€
333-022-2	97	21,11
333-024-2	97	21,11
333-026-2	97	21,11
333-028-2	97	21,11
333-030-2	97	21,11
407-10-200	100	9,43
407-12-250	100	12,23
407-14-250	100	15,19
407-4-100	100	3,53
407-4-75	100	3,47
407-5.5-100	100	4,41
407-5.5-125	100	4,55
407-6.5-125	100	5,68
407-6.5-150	100	6,38
407-8-150	100	7,17
407-8-175	100	7,34
408-2.5-75	100	2,54
408-3-100	100	3,05
408-3-200	100	4,41
408-3-75	100	2,84
408-3.5-100	100	3,15
408-4-100	100	3,62
408-4-125	100	3,66
408-4-250	100	5,55
408-5.5-125	100	4,55
408-5.5-150	100	5,12
408-5.5-25	100	5,99
408-5.5-300	100	6,56
408-6.5-150	100	6,16
408-6.5-25	100	6,32
408V-2.5-100	104	4,45
408V-3-100	104	4,58
408V-3.5-100	104	4,81
408V-4-100	104	4,98
408V-5.5-125	104	6,73
408V-6.5-150	104	7,64
408V-8-175	104	8,74
409-0-75	101	3,47
409-1-100	101	4,24
409-1-25	101	6,21
409-1-250	101	6,38
409-2-125	101	5,28
409-2-25	101	6,43
409-2-300	101	7,91
409-3-150	101	8,17
409-4-200	101	11,36
409V-0-100	104	4,55
409V-1-150	104	5,68
409V-2-175	104	7,51
409V-3-200	104	9,11
413-0-75	101	4,10
413-1-100	101	4,72
413-1-25	101	5,26
413-2-125	101	5,73
413-2-25	101	5,26
413-3-150	101	8,52
413-4-200	101	10,81
413V-0-100	104	5,20

€	📖	€
413V-1-150	104	6,51
413V-2-175	104	7,51
413V-3-200	104	9,11
414-10-75	102	4,51
414-15-100	102	4,72
414-20-100	102	4,76
414-25-125	102	5,59
414-27-125	102	5,55
414-30-150	102	6,68
414-40-150	102	8,13
414-45-150	102	8,54
414-5-75	102	4,91
414-6-75	102	3,73
414-7-75	102	3,73
414-8-75	102	3,73
414-9-75	102	3,73
414V-10-100	104	5,48
414V-15-125	104	6,85
414V-20-125	104	7,91
414V-25-150	104	9,58
417-10-125	102	11,97
417-11-125	102	13,02
417-12-125	102	13,46
417-13-125	102	15,46
417-14-125	102	16,07
417-3.2-125	102	9,88
417-4-125	102	9,09
417-4.5-125	102	9,09
417-5-125	102	9,43
417-5.5-125	102	9,43
417-6-125	102	9,43
417-7-125	102	10,57
417-8-125	102	10,83
417-9-125	102	11,45
42-H10-200	108	13,80
42-H2-100	108	6,64
42-H2.5-100	108	6,64
42-H3-100	108	6,71
42-H4-150	108	7,61
42-H5-150	108	7,92
42-H6-200	108	11,38
42-H8-200	108	12,47
420-3-1	113	8,77
427411	110	4,13
429-03-1	111	3,96
429-04-1	111	3,90
429-10-1	111	4,86
42B-6-B	109	63,95
42B-H10-200	109	14,75
42B-H3-100	109	7,17
42B-H4-150	109	8,13
42B-H5-150	109	8,45
42B-H6-200	109	12,14
42B-H8-200	109	13,31
45-00-1	114	0,53
45-01-1	114	0,53
45-02-1	114	0,58
45-03-1	114	0,67

€	📖	€
45-04-1	114	0,68
45-05-1	114	0,98
45-06-1	114	1,18
45-08-1	114	1,79
45-10-1	114	2,49
454-8-F	118	14,24
454-9-H	118	25,24
454091	118	5,03
454101	118	5,16
454151	118	5,30
454201	118	5,49
454251	118	5,55
454271	118	5,64
454301	118	5,73
454401	118	5,97
457-10-1	117	4,54
457-15-1	117	4,63
457-20-1	117	4,81
457-25-1	117	4,86
457-27-1	117	4,96
457-30-1	117	5,01
457-40-1	117	5,23
457-45-1	117	5,46
457-50-1	117	6,22
457061	117	3,99
457071	117	4,04
457081	117	4,11
457091	117	4,16
457101	117	4,25
457151	117	4,36
457201	117	4,54
457251	117	4,58
457271	117	4,66
457301	117	4,72
457401	117	4,94
457451	117	5,16
457501	117	5,88
458-02-1	110	4,71
458-8-F	117	11,30
458-9-H	117	19,65
459-5-B	106	22,41
459-6-C	105	27,18
459-6A-C	105	27,18
459-6B-C	106	31,83
459-6C-C	106	26,07
459V-3-1	105	19,92
459V-6-C	108	40,35
46-8-F	114	11,18
46-9-H	114	7,78
46-T10-100	109	8,19
46-T15-150	109	8,88
46-T20-150	109	9,15
46-T25-150	109	9,76
46-T30-200	109	10,10
46-T40-200	109	10,98
461-6-B	111	11,62
47-00-1	116	1,29
47-01-1	116	1,45

€	📖	€
47-02-1	116	1,52
47-03-1	116	1,59
47-04-1	116	1,87
47-05-1	116	2,27
47-06-1	116	3,44
47-08-1	116	4,79
47-10-1	116	8,57
470-10.0-1	128	8,24
470-12.0-1	128	8,45
470-14.0-1	128	11,26
470-5.5-1	128	5,74
470-6.5-1	128	5,86
470-8.0-1	128	6,23
470-H10-1	128	6,76
470-H4-1	128	4,68
470-H5-1	128	4,68
470-H6-1	128	4,68
470-H7-1	128	4,68
470-H8-1	128	4,68
470-PH1-1	128	3,91
470-PH2-1	128	3,91
470-PH3-1	128	3,91
470-PH4-1	128	4,90
470-T20-1	128	5,02
470-T25-1	128	5,02
470-T27-1	128	5,02
470-T30-1	128	5,02
470-T40-1	128	5,02
470-T45-1	128	5,02
470-T50-1	128	5,86
470-T55-1	128	6,79
470011	129	29,40
470051	129	6,82
471-18-1	127	19,14
471011	129	60,47
474M-1/4-1	124	6,17
474M-10-1	124	5,64
474M-11-1	124	5,64
474M-12-1	124	5,64
474M-13-1	124	5,64
474M-3/8-1	124	5,64
474M-5-H	124	23,84
474M-5.5-1	124	5,64
474M-6-1	124	5,46
474M-7-1	124	5,46
474M-8-1	124	5,46
474M-9-1	124	5,58
474MR-10-1	124	5,76
474MR-8-1	124	5,64
475-1/4-125	102	17,70
475-1/4F-160	102	17,56
475-150PH1-1	120	14,36
475-150PH2-1	120	14,36
475-150PZ1-1	121	14,36
475-150PZ2-1	121	14,36
475-150T10-1	122	11,34
475-150T15-1	122	11,34
475-150T20-1	122	11,34

€	📖	€
475-150T25-1	122	11,34
475-150T30-1	122	11,34
475-150T40-1	122	11,34
475-32-1	126	12,95
475-32-8DISP	126	103,67
475-32A-1	126	28,26
475-4-1	119	6,98
475-4.5-1	119	6,98
475-5-1	110	7,15
475-5.5-1	119	6,98
475-50PH1-1	119	7,38
475-50PH2-1	119	7,38
475-50PH3-1	119	7,38
475-50PZ1-1	120	7,38
475-50PZ2-1	120	7,38
475-50PZ3-1	120	7,38
475-50T10-1	121	7,56
475-50T15-1	121	7,73
475-50T20-1	121	7,73
475-50T25-1	121	7,80
475-50T30-1	121	7,80
475-50T40-1	121	7,80
475-50T6-1	121	7,56
475-50T8-1	121	7,56
475-6.0-1	119	7,09
475-6.5-1	119	7,50
475-61-1	127	23,00
475-70-3.0-1	119	9,25
475-70-3.5-1	119	9,31
475-70-5.5-1	119	9,48
475-70-6.5-1	119	9,82
475-70PH1-1	119	9,89
475-70PH2-1	119	9,89
475-70PH3-1	119	9,89
475-70PZ1-1	121	9,89
475-70PZ2-1	121	9,89
475-70PZ3-1	121	9,89
475-8.0-1	119	10,94
475-89PH1-1	120	11,45
475-89PH2-1	120	11,45
475-89PH3-1	120	11,45
475-89PZ1-1	121	11,45
475-89PZ2-1	121	11,45
475-89PZ3-1	121	11,45
475-89T10-1	122	8,72
475-89T15-1	122	8,72
475-89T20-1	122	8,72
475-89T25-1	122	8,72
475-89T27-1	122	8,72
475-89T30-1	122	8,72
475-89T40-1	122	8,72
475-9-1	127	8,08
475-H3-1	122	7,14
475-H4-1	122	7,14
475-H5-1	122	7,14
475-H6-1	122	7,14
475-PH0-1	119	3,99
475-PH1-1	119	3,99

€	📖	€
475-PH2-1	119	3,99
475-PH2G-1	120	3,99
475-PH3-1	119	3,99
475-PZ0-1	120	3,99
475-PZ1-1	120	3,99
475-PZ2-1	120	3,99
475-PZ3-1	120	3,99
475-T10-1	121	6,12
475-T15-1	121	6,12
475-T20-1	121	6,12
475-T25-1	121	6,12
475-T27-1	121	6,12
475-T30-1	121	3,23
475-T40-1	121	3,23
475-T45-1	121	6,81
475-T5-1	121	6,00
475-T50-1	121	6,81
475-T6-1	121	6,00
475-T7-1	121	6,00
475-T8-1	121	6,00
475-T9-1	121	6,00
475-TR10-1	122	7,07
475-TR15-1	122	7,07
475-TR20-1	122	7,07
475-TR25-1	122	7,07
475-TR27-1	122	7,07
475-TR30-1	122	7,07
475-TR40-1	122	7,07
475A-25-1	125	1,79
475A-50-1	125	5,57
475A-50-1/2-1	125	7,74
475A-60QR-1	125	11,34
475A-75QR-1	125	11,92
475A-M-150-1	125	10,76
475A-M-50-1	125	7,27
475A-M-75-1	125	7,68
475D-PH1-1	123	9,94
475D-PH2-1	123	9,94
475D-PH3-1	123	9,94
475D-PZ1-1	123	9,94
475D-PZ2-1	123	9,94
475D-PZ3-1	123	9,94
475R-1/4-110	103	18,61
475R-1/4-30	103	16,28
475T-PH1-1	123	9,94
475T-PH2-2	123	9,94
475T-PH3-2	123	9,94
475T-PZ1-1	123	9,94
475T-PZ2-2	123	9,94
475T-PZ3-2	123	9,94
478-4-1	111	3,99
478-4-2	111	3,37
48-9-H	116	15,72
48-9C-H	113	15,99
48A-13-H	116	16,48
5-100-1	36	11,34
5-100-2	36	10,18
5-100C-1	36	9,03

€	📖	€
5-150-1	36	11,97
5-150-2	36	11,35
5-150C-1	36	9,47
5-200-1	36	13,77
5-200-2	36	12,96
5-200C-1	36	10,89
5-250-1	36	16,93
5-250-2	36	16,21
5-250C-1	36	13,25
5-300-1	36	22,31
5-300-2	36	21,65
5-300C-1	36	17,54
5-375-2	36	43,97
5-375C-2	36	34,45
5-4-W	37	72,20
5-450-2	36	70,99
5-450C-2	36	57,48
500-240-1	134	15,02
501-150-1	134	9,33
501-175-1	134	9,22
501-200-1	134	12,44
501-250-1	134	15,98
501-300-1	134	21,76
502-230-1	134	12,91
503-200-1	138	6,24
503-250-1	138	6,50
503-300-1	138	7,47
504-150-1	134	8,76
504-175-1	134	11,62
504-200-1	134	12,21
504-250-1	134	14,51
504-300-1	134	16,56
505-150-1	134	7,67
505-200-1	134	10,55
505-250-1	134	15,55
506-150-1	134	8,87
506-175-1	134	11,34
506-200-1	134	12,03
51-06-1	46	8,46
51-07-1	46	8,84
51-08-1	46	9,01
51-09-1	46	9,80
51-10-1	46	10,15
51-11-1	46	10,62
51-12-1	46	11,14
51-13-1	46	12,16
51-14-1	46	13,19
51-15-1	46	14,21
51-16-1	46	15,65
51-17-1	46	15,97
51-18-1	46	17,42
51-19-1	46	18,05
51-20-1	46	20,20
51-21-1	46	22,38
51-22-1	46	24,12
51-23-1	46	27,54
51-24-1	46	27,95
51-25-1	46	30,71

€	📖	€
51-26-1	46	34,54
51-27-1	46	37,62
51-28-1	46	41,22
51-29-1	46	44,01
51-30-1	46	46,48
51-32-1	46	48,24
51-8-W	46	117,50
511-100-1	135	3,47
511-105-1	135	3,47
511-110-1	135	3,47
511-115-1	135	3,89
511-130-1	135	4,61
511-91-4	135	15,44
511-92-4	135	18,97
511501	138	5,98
512-010-1	135	3,47
512-012-1	135	4,31
513-002-1	135	3,28
513-003-1	135	3,28
513-004-1	135	3,47
513-005-1	135	3,47
513-006-1	135	4,14
513-008-1	135	4,51
513-010-1	135	6,05
513-91-4	136	21,45
513-92-4	136	28,19
514-002-1	135	3,30
514-003-1	135	3,30
514-004-1	135	3,50
514-005-1	135	3,50
514-006-1	135	4,18
515-002-1	136	3,78
515-003-1	136	3,78
515-004-1	136	3,78
515-005-1	136	3,89
515-006-1	136	3,89
515-007-1	136	3,89
515-008-1	136	4,71
515-009-1	136	4,71
515-010-1	136	5,88
515-91-4	137	26,94
516-002-1	136	5,30
516-003-1	136	5,30
516-004-1	136	5,30
516-005-1	136	5,30
516-006-1	136	5,30
516-008-1	136	5,99
517-120-1	137	3,94
517-130-1	137	4,06
517-135-1	137	4,13
517-140-1	137	4,21
517-145-1	137	4,31
517-150-1	137	4,67
517-91-4	137	25,34
518-004-1	137	5,96
518-006-1	137	5,96
519-91-4	136	20,19
519-92-4	137	32,50

€	📖	€
519-93-4	138	32,99
52-06-1	46	8,46
52-07-1	46	8,84
52-08-1	46	9,01
52-09-1	46	9,80
52-10-1	46	10,15
52-11-1	46	10,62
52-12-1	46	11,14
52-13-1	46	12,16
52-14-1	46	13,19
52-15-1	46	14,21
52-16-1	46	15,65
52-17-1	46	15,97
52-18-1	46	17,42
52-19-1	46	18,05
52-20-1	46	20,20
52-21-1	46	22,38
52-22-1	46	24,12
52-23-1	46	27,54
52-24-1	46	27,95
52-25-1	46	30,71
52-26-1	46	34,54
52-27-1	46	37,62
52-28-1	46	41,22
52-29-1	46	44,01
52-30-1	46	46,48
52-32-1	46	48,24
52-8-W	46	117,50
520-13S-1	139	10,03
520-41-2	139	16,55
520-42-2	139	6,16
520-43-2	139	18,21
520-61-2	139	17,28
520-63-2	139	19,00
521-51-2	139	16,52
521-52-2	139	9,30
521-53-2	139	15,78
521-54-2	139	6,44
521-71-2	139	18,02
521-73-2	139	16,88
521-81-2	139	19,53
521-82-2	139	9,46
521-83-2	139	17,99
521-84-2	139	6,58
522-21-2	140	12,02
522-22-2	140	6,83
522-23-2	140	12,61
522-31-2	140	15,02
522-32-2	140	8,56
522-33-2	140	15,78
522-41-2	140	18,02
522-42-2	140	8,86
522-43-2	140	18,93
525-11-2	140	5,65
525-12-2	140	2,67
525-21-2	140	12,52
525-22-2	140	4,05
525-31-2	140	13,81

€	📖	€
525-32-2	140	5,26
525-41-2	140	18,79
525-42-2	140	6,62
525-43-2	140	20,67
525-61-2	140	22,98
525-62-2	140	7,82
525-71-2	140	26,29
525-72-2	140	8,72
525-81-2	140	30,36
525-82-2	140	9,46
525-91-2	140	21,06
525-92-2	140	10,08
526-31-2	141	12,10
526-32-2	141	4,05
526-41-2	141	13,47
526-42-2	141	4,51
526-51-2	141	17,24
526-52-2	141	6,16
526-53-2	141	18,97
526-61-2	141	19,98
526-62-2	141	7,51
526-71-2	141	23,13
526-72-2	141	9,46
526-91-2	141	23,37
526-92-2	141	10,36
527-31-2	141	12,42
527-32-2	141	7,07
527-33-2	141	13,66
527-41-2	141	14,23
527-43-2	141	15,65
527-51-2	141	16,31
527-52-2	141	10,07
527-53-2	141	17,93
527-61-2	141	16,91
527-63-2	141	18,15
527-71-2	141	17,59
527-73-2	141	19,35
527-81-2	141	19,00
527-82-2	141	10,97
527-83-2	141	20,91
527-91-2	141	21,02
527-93-2	141	23,13
529021	143	16,40
529031	143	21,87
529041	143	30,94
529061	143	1,39
529071	143	1,92
529081	143	2,69
529091	143	3,71
529101	143	5,64
529151	143	7,67
529161	143	10,95
529171	143	13,61
529181	143	20,13
529191	143	38,74
529251	142	6,93
529261	142	8,33
529271	142	11,09

€	📖	€
529291	142	12,52
529611	143	24,87
529621	143	41,10
529631	143	53,48
529701	143	2,61
529711	143	4,15
529721	143	5,75
529751	143	1,82
529761	143	2,09
529771	143	2,32
529781	143	2,55
529791	143	2,79
529801	143	3,09
529811	143	3,32
529821	143	3,38
530-03-2	142	14,12
530-05-2	142	15,68
530-07-2	142	17,53
530-13-2	142	9,89
530-15-2	142	9,89
531-05-2	142	21,78
531-07-2	142	22,53
531-08-2	142	23,28
531-09-2	142	26,29
531-15-2	142	5,55
531-17-2	142	5,55
531-18-2	142	7,82
531-19-2	142	7,82
534251	172	8,51
534261	172	9,48
534281	172	8,51
534291	172	9,48
534311	173	7,40
534321	173	8,96
534341	173	8,64
534351	173	11,23
534371	173	10,19
534381	173	12,26
534401	173	5,89
534411	173	6,18
534501	173	67,36
534521	172	8,44
534531	172	9,35
534541	172	11,95
534551	172	14,94
534561	172	8,44
534571	172	9,35
534601	173	7,08
534611	173	8,56
534621	173	10,87
534681	173	10,19
534691	173	11,69
534701	173	15,48
534901	173	7,51
534911	173	7,78
534931	173	6,56
534941	173	6,78
536011	180	16,39

€	📖	€
538-140-1	160	5,57
540021	180	3,23
540031	180	3,25
540041	180	3,37
540051	180	3,49
540061	180	3,59
540071	180	3,88
540081	180	4,09
540091	180	4,39
540101	180	4,92
540121	180	5,76
546-265-1	159	54,94
546-265-4	159	56,68
546-265-A	159	15,17
546-265-B	159	9,29
546021	159	182,77
546201	159	5,12
546211	159	5,12
546221	159	5,12
546251	159	18,97
548-275-1	159	98,19
548-275-M3	159	4,77
548-275-M4	159	4,77
548-275-M5	159	4,77
548-275-M6	159	4,77
549-230-2	180	8,48
550-80-4	180	30,24
551-HG-1	181	61,80
551-NOZ-1	181	4,02
560-41-1	182	20,42
560-41LP-1	181	23,11
560-BN-15	182	1,99
560-CA-10	182	2,77
560-CA-12	182	2,90
560-CA-14	182	3,03
560-HD-06	182	2,43
560-HD-08	182	2,68
560-HD-10	182	2,77
560-HD-12	182	2,90
560-HD-14	182	3,03
560-HT-1	182	12,48
560-HTS-1	181	13,03
560-LD-06	182	1,83
560-LD-08	182	2,05
560-LD-10	182	2,08
560-LD-12	182	2,17
560-LD-14	182	2,24
601-160-1	146	10,90
601-180-1	146	11,80
601-200-1	146	12,42
601-3-C	147	38,22
601911	155	93,57
601M-125-1	148	11,32
601V-160-1	151	18,86
601V-180-1	151	21,01
601V-200-1	151	23,23
601V-3-C	153	63,10
602-3-C	147	38,35

€	📖	€
604-160-1	146	11,56
604-180-1	146	18,74
604M-125-1	148	11,32
604V-160-1	151	23,41
608-160-1	147	11,70
612-160-1	146	12,99
612-200-1	146	14,76
612M-125-1	148	11,32
612V-160-1	152	19,98
612V-200-1	152	22,77
613-160-1	146	14,29
613-200-1	146	15,36
613V-160-1	152	21,05
613V-200-1	152	24,63
621551	155	17,41
621561	155	17,41
621571	155	19,88
621581	155	24,70
621591	155	32,81
621651	155	17,64
621661	155	17,64
621671	155	20,35
621681	155	25,76
621691	155	36,22
621751	155	18,24
621761	155	18,24
621771	155	20,23
621781	155	24,58
621791	155	36,45
621851	155	18,47
621861	155	18,47
621871	155	20,93
621881	155	25,76
621891	155	36,45
624-140-1	146	10,91
624-160-1	146	11,67
624-180-1	146	12,83
624M-125-1	148	11,32
624V-140-1	152	17,25
624V-160-1	152	19,33
625-180-1	146	14,19
625-200-1	146	15,48
625V-180-1	152	21,65
626M-125-1	149	11,32
629-160-1	149	15,61
629V-160-1	153	25,37
630-295T-4	151	27,11
630-5HD-4	151	94,19
630-61B1-4	150	21,35
630-B1-1	150	11,27
630-B2-1	150	11,27
630-B3-1	150	11,27
631-200-1	153	12,85
632-220-1	153	11,64
632-250-1	153	13,07
632-280-1	153	15,44
632D-250-1	154	15,32
634-200-1	147	14,39

€	📖	€
634-250-1	147	14,88
634-300-1	147	24,79
634Q-250-1	147	21,08
634V-250-1	153	27,28
645011	158	56,13
645021	158	59,70
645031	158	62,57
645041	158	77,36
647-235-1	158	47,41
647-250-1	158	52,72
648-140-1	158	15,65
648-165-1	158	15,97
648-185-1	158	16,27
648-250-1	158	17,21
648-4-W	158	57,09
64A-190-1	156	21,74
64A-235-1	156	24,80
64B-190-1	156	22,13
64B-235-1	156	24,80
64C-300-1	157	34,27
64CA-175-1	157	24,26
64CA-300-1	157	32,00
64CA-450-1	157	54,04
64CAD-300-1	157	31,90
64L-165-1	157	16,78
64T-300-1	157	49,99
64W-300-1	157	33,56
651101	154	50,07
651111	154	80,12
651121	154	96,33
651131	154	126,44
651141	154	164,40
651201N	154	36,08
651201N2	154	36,08
651211N	154	42,99
651211N2	154	42,99
651221N	154	51,69
651221N2	154	51,69
651231N	154	67,87
651231N2	154	67,87
651241N	154	87,58
651241N2	154	87,58
655-160-1	149	22,47
655-200-1	149	27,57
658-250-1	156	21,98
659-250-1	156	21,98
660-250-1	156	21,98
661-140-1	162	20,68
661-140-12-DISP	162	235,19
661051	162	10,12
661061	162	15,61
664-200-1	161	13,28
665-200-1	161	12,03
666-156-1	160	6,78
667-135-1	160	4,02
668-150-1	160	5,09
669-175-1	160	7,54
669-190-1	161	17,35

€	📖	€
670-178-1	161	14,87
671-150-1	161	28,50
672-220-1	161	8,40
701-130-1	164	73,57
701-130-B	164	19,09
701-160-1	164	121,91
701-160-B	164	34,15
701-160-K	164	43,90
701-160-S	164	14,64
701-200-1	164	126,10
701-200-B	164	39,99
701-250-1	164	211,06
701-250-B	164	88,44
701-250-K	164	113,74
701-250-S	164	37,95
701-350-1	164	249,84
701-350-B	164	124,51
701-90-1	164	70,42
701-90-B	164	17,51
701-90-K	164	22,57
701-90-S	164	7,51
702-40-1	164	23,06
702-40-B	164	4,03
702-40-K	164-165	4,07
702-40-P	164-165	0,48
702-40-S	164-165	1,34
702-65-1	164	24,84
702-65-K	164-165	4,99
702-65-S	164-165	1,70
702-80-1	164	43,27
702-80-K	164-165	6,59
702-80-S	164-165	2,20
703-40-1	165	31,90
703-40-B	165	4,02
703-65-1	165	34,50
703-80-1	165	53,72
71-UN7-1	49	16,89
71-UN9-1	49	15,67
713001	165	213,20
713011	165	316,43
713511	165	27,89
713521	165	27,89
713531	165	29,63
713541	165	29,63
713611	165	41,43
716-5-1	166	21,45
716-8-1	166	66,45
716-M11-1	166	7,70
716-M14-1	166	9,46
716-M18-1	166	11,34
716-M6-1	166	3,95
716-M8-1	166	5,53
718211	166	27,52
718231	166	35,51
720-1M-413	167	31,90
720-3M-413	167	61,27
720-LM-1	167	12,77
720031	167	5,91

€	📖	€
722-4-1	162	11,16
730011	166	57,44
730131	166	136,15
7309-1-10	52	25,49
7309-1-11	52	25,49
7309-1-12	52	25,49
7309-1-13	52	25,49
7309-1-14	52	25,49
7309-1-17	52	25,49
7309-1-19	52	25,49
7309-1/2	53	61,66
7309-1/4	53	58,07
7309-125	52	149,33
7309-2-10	52	27,63
7309-2-11	52	27,63
7309-2-12	52	27,63
7309-2-13	52	27,63
7309-2-14	52	27,63
7309-2-17	52	27,63
7309-2-19	52	27,63
7309-2-22	52	27,63
7309-3/8	53	60,41
7309-30	52	130,95
7309-60	52	130,95
7314-1-13	53	29,06
7314-1-14	53	29,06
7314-1-17	53	29,06
7314-1-19	53	29,06
7314-1-22	53	34,92
7314-1-24	53	34,92
7314-1-27	53	39,55
7314-1-30	53	39,55
7314-1-32	53	39,55
7314-1/2	53	65,08
7314-2-13	53	30,24
7314-2-14	53	30,24
7314-2-17	53	30,24
7314-2-19	53	30,24
7314-2-22	53	34,92
7314-2-24	53	34,92
7314-2-27	53	34,92
7314-2-30	53	39,55
7314-2-32	53	39,55
7314-2-36	53	43,05
7314-2-41	53	43,05
7314-200	52	164,80
7314-335	52	178,37
740-016-2	168	52,87
740-020-2	168	66,54
740-022-2	168	66,54
740-025-2	168	77,01
740-030-2	168	81,86
740-035-2	168	98,29
740-040-2	168	112,36
740-050-2	168	137,91
740S-008-2	168	1,86
740S-010-2	168	1,98
740S-012-2	168	3,10

€	📖	€
740S-014-2	168	4,34
796491	165	33,66
796501	165	53,63
796511	165	21,58
796521	165	19,98
796531	165	19,98
796541	165	21,58
796551	165	1,08
796561	165	105,93
796571	165	1,81
800-111-1	171	28,22
800-131-1	170	15,07
800-141-1	171	17,27
800-151-1	170	10,00
801-011-1	172	13,95
801-041-1	171	13,11
801-145-1	172	13,46
801101	171	21,87
802-2400-1	170	9,08
802-2423-1	170	4,72
802-2451-1	170	3,83
802-3000-1	170	10,19
802-3023-1	170	4,42
802-3051-1	170	4,42
802-3600-1	170	11,66
802-3623-1	170	4,92
802-3651-1	170	4,92
803-318-5	171	9,79
803-318-50	171	1,96
803-324-5	171	9,79
803-324-50	171	1,96
803-332-5	171	9,79
803-332-50	171	1,96
805-3-C	144	19,99
806-6-B	144	31,29
810-2264-4	172	68,82
902021	27	42,61
902031	27	46,32
902131	27	59,02
9021FTW520	24	250,09
9021FTW520-AC1	24	10,43
9021FTW520-AC2	24	3,72
9021FTW520-AC3	24	8,14
9021FTW520-AC4	24	25,26
9021FTW520-AC5	24	9,47
9021FTW520FF1	24	549,45
9022-1-16SB	30	27,25
9022-1-19HB	30	65,71
9022-2-16HB	30	32,12
9022-2-19HB	30	38,66
9022-3-10	34	11,60
9022-3-20	32	10,32
9022-3-20TS1	32	21,92
9022-3-20TS2	32	25,79
9022-3-30	33	9,03
9022-3-30TS1	33	36,10
9022-3-30TS2	33	37,40
9022-3-40	33	14,18

€	📖	€
9022-3-40TS1	33	65,77
9022-3-40TS2	33	83,82
9022-3-50	34	24,51
9022-3-50TS1	34	88,96
9022-4-26	31	15,15
9022-4-26TS1	32	63,15
9022-4-35	31	20,21
9022-4-35TS1	32	119,99
9022-BP1	31	60,85
9022-BPW	31	102,28
9023PT565	29	65,74
9023PT565TS1	29	295,83
9024-1TS1	28	368,82
9024-1TS145	28	489,21
9062-1500-1	26	513,97
9062-1800-1	26	561,35
9062-CAST-1	26	55,00
9062-FIX-1	26	15,00
9062-HOOK-1	26	20,60
9062-P1500-1	26	110,00
9062-P1800-1	26	130,00
9062FWB160	27	71,59
9063FT90	25	75,78
9063HT150	25	63,15
9063HT150FI	25	8,24
9063HT150SW	25	9,27
9063HT300	25	94,74
9063HT300FI	25	12,36
9063HT300SW	25	14,32
9064-15	14	18,95
9064AC01	14	18,29
9064K-02	25	173,25
9064K-02T	25	47,62
9065K4	14	587,33
9066K-01	14	18,85
9066K-02	14	29,68
9066K-03	14	24,63
9066K-05	14	28,38
9066K-06	14	13,71
9066K5	14	798,42
9066K6	14	830,00
9066K6FF100	15	1.235,34
9066K6FF101	16	1.418,83
9066K7	14	856,89
9066K7FF102	17	1.649,29
910-152DISP	107	707,35
910-83DISP	107	409,28
910V-72DISP	108	421,49
971-13-1	178	8,18
971-20-1	178	10,83
972-52-1	178	12,12
980-20S-1	177	15,23
980-3-1	176	3,76
980-3B-1	176	5,86
980-5-1	176	5,37
980-5-25-1	176	9,11
980-5B-1	176	9,49
980-5W-1	177	10,34

€	📖	€
980-8B-1	176	18,50
980-TP2-1	176	17,85
980HV-3-1	176	6,05
980HV-5-1	176	8,75
981-1000-1	174	19,19
981-1200-1	174	20,94
981-1500-1	174	24,42
981-1800-1	174	28,79
981-2000-1	174	30,55
981-400-1	174	10,27
981-400M-1	174	15,11
981-600-1	174	12,51
981-600M-1	174	18,74
981-800-1	174	17,04
981-SET	175	65,42
982-10-1	175	6,20
982-40-1	174	13,65
982-4M-1	174	15,25
982-60-1	174	16,61
982-6M-1	174	27,71
982-80-1	174	22,63
982-SET	175	13,84
982-TOR-1	175	8,04
983-25-1	175	18,60
984-6-1	179	30,10
984-6D-1	179	42,08
985-2-1	177	4,22
991-200-1	178	8,46
991-250-1	178	10,27
991-300-1	178	12,09
991-400-1	178	14,75
993-150-1	178	11,48
993-300-1	178	16,33
993-400-1	178	18,74
CEE-COUNT-IR-1	193	-
IFF1A001	18	172,07
IFF1A002	18	175,93
IFF1A003	18	181,17
IFF1A004	19	191,25
IFF1A005	19	218,39
IFF1A006	19	206,90
IFF1A007	20	169,73
IFF1E001	20	70,44
IFF1E002	20	86,11
IFF1E003	20	61,73
IFF1E004	20	81,40
IFF1E005	20	157,42
IFF1E006	20	49,42
IFF1E007	21	42,33
IFF1E008	21	35,87
IFF1E009	21	36,65
IFF1E010	21	71,40
IFF1E011	21	63,78
IFF1E012	21	94,19
IFF1E013	22	58,34
IFF1E014	22	59,02
IFF1E015	22	145,30
IFF1E016	22	91,47

€	📖	€
IFF1E017	22	52,91
IFF1E018	22	49,54
IFF1E019	23	62,48
IFF1E021	23	153,75
IFF1E023	23	44,76
IFF1E024	23	67,57
IFF1E025	23	46,34
L-ALUM-1	185	5,23
L-ALUM-12DISP	185	62,80
L-BOOK-1	186	52,34
L-COMP-1	184	48,84
L-FLEX-1	184	57,02
L-FRONT-1	186	17,66
L-HEAD-1	186	29,08
L-MINI-1	185	33,72
L-PEN-1	185	22,09
L-POCK-1	185	31,40
L-SLIM-1	184	52,34
LT-420-1	179	42,31
MEE-1S2L-B-I	190-191	-
MEE-BANNER-I	192	-
MEE-COR-1L-B-I	191	-
MEE-COR-LIGHT-I	191	-
MEE-COUNT-IR-1	193	-
MEE-COUNT-IR-2	107-108-193	-
MEE-COUNT-IR-3	107-193	-
MEE-DB-W-NL	192	-
MEE-LIGHTBOX-I	191	-
MEE-SA-SS-IR	193	-
MEE-SIGN-CARR-I	191	-
MEE-TR-W-I	192	-
P-IW-12	187	144,20
P-IW-12C	187	157,59
P-IW-12P	187	183,34
P-IW-34	187	252,35
P218	188	10,72
P254	189	47,69
P255	189	80,01
P700	188	163,78
P821	188	204,74
PEE-COUNT-006	193	-
PEE-METHACRYL-I	192	-
PEE-PC-IR-1	193	-
PEE-SIGN-DB-W-2	192	-
PEE-TOPSIGN-I	192	-
PM5002	188	5,24
PM5003	188	5,01
PM5012	188	5,40
PM5013	188	10,10
PM5142	188	1,93
PM5143	188	1,57
PM5152	188	1,02
PM5153	188	1,57
PM5248	188	1,77
PN251	188	13,43
PPOS-A4-STICK-I	193	-
T49	132	103,72
T4901	130	7,15

🔍	📖	€
T4902	130	6,14
T49H10	130	2,75
T49H10L	130	4,09
T49H10XL	130	6,88
T49H12	130	3,26
T49H12L	130	5,13
T49H14	130	5,13
T49H4	130	2,75
T49H4L	130	4,09
T49H5	130	2,75
T49H5L	130	4,09
T49H6	130	2,75
T49H6L	130	4,09
T49H7	130	2,75
T49H7L	130	4,09
T49H8	130	2,75
T49H8L	130	4,09
T49M10	131	2,75
T49M10L	131	4,09
T49M12	131	3,26
T49M12L	131	5,13
T49M14	131	4,33
T49M5	131	2,75
T49M5L	131	4,09
T49M6	131	2,75
T49M6L	131	4,09
T49M8	131	2,75
T49M8L	131	4,09
T49SQ10	131	4,82
T49SQ8	131	4,02
T49T20	130	2,63
T49T20H	131	2,75
T49T20HL	131	4,09

🔍	📖	€
T49T20L	130	3,88
T49T25	130	2,63
T49T25H	131	2,75
T49T25HL	131	4,09
T49T25L	130	3,88
T49T27	130	2,63
T49T27H	131	2,75
T49T27HL	131	4,09
T49T27L	130	3,88
T49T30	130	2,63
T49T30H	131	2,75
T49T30HL	131	4,09
T49T30L	130	3,88
T49T30XL	67-132	10,36
T49T40	130	2,63
T49T40H	131	2,75
T49T40HL	131	4,09
T49T40L	130	3,88
T49T40XL	67-132	10,36
T49T45	130	2,63
T49T45H	131	2,75
T49T45HL	131	4,09
T49T45L	130	3,88
T49T45XL	67-132	10,36
T49T50	130	2,63
T49T50H	131	2,75
T49T50HL	131	4,09
T49T50L	130	3,88
T49T55	130	2,63
T49T55H	131	2,75
T49T55HL	131	4,09
T49T55L	130	3,88
T49T55XL	130	7,15

🔍	📖	€
T49T60	130	4,07
T49T60H	131	4,28
T49T60HL	131	5,61
T49T60L	130	5,32
T49T70HL	67-132	18,55
T49T80HL	67-132	18,55
WB-300-2	138	30,32
WB-500-2	138	31,30
WB-625-2	138	35,35
WB-710-2	138	37,36
WB-900-2	138	40,20
ZH1100	166	92,40
ZH1101	166	4,23
ZH1102	166	4,23
ZH1103	166	4,23
ZH1104	166	4,23
ZH1105	166	4,23
ZH1106	166	4,23
ZH1107	166	4,23
ZH1108	166	4,23
ZH1109	166	4,23
ZH1110	166	4,23
ZH1111	166	4,23
ZH1112	166	4,23
ZH1113	166	4,23
ZH1114	166	4,23
ZH1115	166	4,23
ZH70610	168	32,45
ZH70611	168	8,68
ZH70612	168	11,16
ZH70613	168	17,35
ZH70614	168	21,07

TORNILLOS HEXAGONALES HEMBRA

mm	mm.					mm	mm	U.S.A.			G.B.	
	DIN 912 DIN 6912	DIN 7984	DIN 7991	DIN 913-916	USAS B 18-3-1969			BS 2470-1954				
1.5	1.6-2	3	2.5	3	1/16"	1.59	Nº 1	Nº 3-Nº 4	Nº 5-Nº 6	6 BA	5 BA-4 BA	
2	2.5	4	3	4	5/64"	1.98	Nº 2-Nº 3	Nº 5-Nº 6	Nº 8	5 BA-4 BA	3 BA	
2.5	3	4	3.5-4	5	3/32"	2.38	Nº 4-Nº 5	Nº 8	Nº 10		3/16-2 BA-1 BA	
3	4	5	5	6	7/64"	2.78	Nº 6		1/4"		0 BA-1/4	
4	5	6	6	8	1/8"	3.17						
5	6	8	8	10	9/64"	3.57	Nº 8					
6	8		10	12	5/32"	3.97	Nº 10	1/4"	5/16"	3/16-2 BA-1 BA	5/16	
7	10	10	12	16	3/16"	4.75	1/4	5/16"	3/8"	1/4-0 BA	3/8-BSP 1/8	
8	10	12	12	16	7/32"	5.55		3/8"	7/16"	5/16"	7/16	
9					1/4"	6.35	5/16"	7/16"	1/2"		1/2-BSP 1/4	
10	12		14-16	20	5/16"	7.94	3/8"	1/2"	5/8"	3/8-7/16"	5/8-BSP 3/8	
12	14	16-18	18-20	24	3/8"	9.52	7/16-1/2"	5/8"	3/4"	1/2"	3/4-BSP 1/2	
14	16-18	20-22			1/2"	12.70			7/8"	5/8"	7/8-BSP 5/8	
17	20-22	24			9/16"	14.29			1"	1-1/8"	1-BSP 3/4	
19	24-27				5/8"	15.88			1 1/4-1 3/8"	1"		
22	30				3/4"	19.05			1 1/2"			

DIÁMETROS DE ROSCAS Y DIMENSIONES ENTRE CARAS

mm	mm.					A.F.	mm	UNIFIED			U.S.A.			G.B.		
	ISO 972 1982	UNE 17052 1978	DIN 931 1970	NFE 27111 1930	DS 2074-5 1988			BS 1769	BS 1768	BS 1768	ASAB 18-2.2 ASAB 18-2.1	ASAB 18-2.1	ASAB 18-2.2	BS 916-1083	BA BS 57W BS 192	
3.2	1.6	1.6	1.6			3/32"	2.38					0.117	2.97		10 BA	
3.5			1.7			1/8"	3.17					0.131	3.32		9 BA	
4	2	2	2	2.5		5/32"	3.97					0.172	4.37		7 BA	
4.5			2.3									0.193	4.90		6 BA	
5	2.5	2.5	2.6	3		3/16"	4.76					0.220	5.59		5 BA	
5.5	3	3	3	3.5		7/32"	5.56					0.248	6.30		4 BA	
6	3	3	3.5	4-4.5		1/4"	6.35					0.282	7.16		3 BA	
7	4	4	4	5		9/32"	7.14					0.324	8.23		2 BA	
8	5	5	5	5.5		5/16"	7.94					0.340	8.64	3/16"	1/8 W	
9						11/32"	8.73					0.365	9.27		1 BA	
10	6	6	6	6		3/8"	9.52					0.413	10.49		0 BA	
11	7	7	7	7	1/4"	7/16"	11.11		1/4"	1/4"		0.445	11.30	1/4"	3/16 W	
12	7	7	7	7												
13	8	8	8	8		1/2"	12.70	1/4"	5/16"	5/16"	1/4"	5/16"	13.34	5/16"	1/4 W	
14						9/16"	14.29	5/16"	3/8"	3/8"	5/16"	5/16"	15.24	3/8"	5/16 W	
15						19/32"	15.08					0.600				
16	10	10	10	9		5/8"	15.88									
17	10	10	10	10	3/8"				7/16"							
18	12	12	12	11		11/16"	17.46	3/8"	7/16"	7/16"		0.710	18.03	7/16"	3/8 W	
19	12	12	12	12	7/16"	3/4"	19.05	7/16"	1/2"	1/2"	7/16"	1/2"	20.83	1/2"	7/16 W	
21	14	14	14	12	1/2"	13/16"	20.64	1/2"	9/16"	9/16"	1/2"	0.820	20.83	1/2"	7/16 W	
22	14	14	14	12		7/8"	22.22									
23				14		15/16"	23.81					0.920	23.37	9/16"	1/2 W	
24	16	16	16	16		1"	25.40		5/8"	5/8"	9/16"	5/8"	25.65	5/8"	9/16 W	
26	16	16	16	16								1.010	25.65	5/8"	9/16 W	
27					5/8"	1 1/16"	26.99	5/8"			5/8"		1.100	27.94	11/16"	5/8 W
28	18	18	18	18		1 1/8"	28.58		3/4"	3/4"	3/4"	3/4"	1.200	30.48	3/4"	11/16 W
29																
30	20	20	20	20	3/4"	1 3/16"	30.16	3/4"			3/4"	1.200	30.48	3/4"	11/16 W	
32						1 1/4"	31.75		7/8"	7/8"	7/8"	1.300	33.02	7/8"	3/4 W	
34	22	22	22	20		1 5/16"	33.34					1.390	35.31	15/16"	13/16 W	
35				22		1 3/8"	34.92	7/8"			7/8"	1.390	35.31	15/16"	13/16 W	
36	24	24	24	24	7/8"	1 7/8"	36.51	7/8"	1"	1"	7/8"	1.480	37.59	1"	7/8 W	
38	24	24	24	24		1 1/2"	38.10									
41	27	27	27	27	1"	1 5/8"	41.28	1"	1 1/8"	1 1/8"	1"	1.670	42.42	1 1/8"	1 W	
42						1 11/16"	42.86									
46	30	30	30	30	1 1/8"	1 3/4"	44.45									
46	30	30	30	30	1 1/8"	1 13/16"	46.04	1 1/8"			1 1/8"	1.860	47.24	1 1/4"	1 1/8 W	
50	33	33	33	33	1 1/4"	1 7/8"	47.62	1 1/4"	1 1/4"	1 1/4"	1 1/4"	2.050	52.07	1 3/8"	1 1/4 W	
54				36		2"	50.80									
55	36	36	36	36	1 3/8"	2 1/16"	52.39	1 3/8"	1 3/8"	1 3/8"	1 3/8"	2.220	56.39	1 1/2"	1 3/8 W	
58	36	36	36	39	1 3/8"	2 3/16"	55.56	1 3/8"	1 1/2"	1 1/2"	1 3/8"	2.410	61.21	1 5/8"	1/2 W	
60	39	39	39	39	1 1/2"	2 1/4"	57.17									
63				42	1 1/2"	2 3/8"	60.32	1 1/2"			1 1/2"	2.580	65.53	1 3/4"	1 5/8 W	
65	42	42	42	42	1 5/8"	2 7/16"	61.91				1 5/8"					
67				45		2 9/16"	65.09									
70	45	45	45	45	1 3/4"	2 5/8"	66.68	1 3/4"	1 3/4"	1 3/4"	1 3/4"	2.760	70.10	2"	1 3/4 W	
71				48	1 3/4"	2 3/4"	69.85				1 3/4"					
75				48		2 13/16"	71.44				1 7/8"					
77	48	48	48	48	1 7/8"	2 15/16"	74.61		1 7/8"	1 7/8"	2"					
78				52		3"	76.20		2"	2"	2"					
80	52	52	52	52	2"	3 1/8"	79.38	2"			2"	3.150	76.70	2 1/4"	1 7/8 W	
82				56												
85	56	56	56	56	2 1/4"	3 3/8"	85.72									
88				60	2 1/4"	3 1/2"	88.90				2 1/4"	2 1/4"				
90	60	60	60	60								3.550	90.17	2 1/2"		
94				64												
95	64	64	64	64	2 1/2"	3 3/4"	95.25				2 1/2"					
100	68	68	68	68		3 7/8"	98.42				2 1/2"	3.890	98.81	2 3/4"	3"	
105	72	72	72	72	2 3/4"	4 1/8"	104.78				2 3/4"	4.180	106.17			
110	76	76	76	76	3"	4 1/4"	107.95				2 3/4"					
115	80	80	80	80		4 1/2"	114.30				3"	4.530	115.06	3 1/4"		
116				80												
120	85	85	85	85	3 1/4"	4 5/8"	117.48				3"	4.850	123.19	3 1/2"		

pulgadas		mm	pulgadas		mm	pulgadas		mm
pulgadas		mm	pulgadas		mm	pulgadas		mm
.	0,0039	0,1000	.	0,5512	14,0000	.	1,8898	48,0000
.	0,0079	0,2000	9/16"	0,5625	14,2875	.	1,9291	49,0000
.	0,0118	0,3000	.	0,5709	14,5000	.	1,9685	50,0000
1/64"	0,0156	0,3969	37/64"	0,5781	14,6844	2"	2,0000	50,8000
.	0,0157	0,4000	.	0,5906	15,0000	.	2,0079	51,0000
.	0,0197	0,5000	19/32"	0,5938	15,0813	.	2,0472	52,0000
.	0,0236	0,6000	39/64"	0,6094	15,4781	.	2,0866	53,0000
.	0,0276	0,7000	.	0,6102	15,5000	.	2,1260	54,0000
1/32"	0,0313	0,7938	5/8"	0,6250	15,8750	.	2,1654	55,0000
.	0,0315	0,8000	.	0,6299	16,0000	.	2,2047	56,0000
.	0,0354	0,9000	41/64"	0,6406	16,2719	.	2,2441	57,0000
.	0,0394	1,0000	.	0,6496	16,5000	2 1/4"	2,2500	57,1500
.	0,0433	1,1000	21/32"	0,6563	16,6688	.	2,2835	58,0000
3/64"	0,0469	1,1906	.	0,6693	17,0000	.	2,3228	59,0000
.	0,0472	1,2000	43/64"	0,6719	17,0656	.	2,3622	60,0000
.	0,0512	1,3000	11/16"	0,6875	17,4625	.	2,4016	61,0000
.	0,0551	1,4000	.	0,6890	17,5000	.	2,4409	62,0000
.	0,0591	1,5000	45/64"	0,7031	17,8594	.	2,4803	63,0000
1/16"	0,0625	1,5875	.	0,7087	18,0000	2 1/2"	2,5000	63,5000
.	0,0630	1,6000	23/32"	0,7188	18,2563	.	2,5197	64,0000
.	0,0669	1,7000	.	0,7283	18,5000	.	2,5591	65,0000
.	0,0709	1,8000	47/64"	0,7344	18,6531	.	2,5984	66,0000
.	0,0748	1,9000	.	0,7480	19,0000	.	2,6378	67,0000
5/64"	0,0781	1,9844	3/4"	0,7500	19,0500	.	2,6772	68,0000
.	0,0787	2,0000	49/64"	0,7656	19,4469	.	2,7165	69,0000
.	0,0827	2,1000	.	0,7677	19,5000	2 3/4"	2,7500	69,8500
.	0,0866	2,2000	25/32"	0,7813	19,8438	.	2,7559	70,0000
.	0,0906	2,3000	.	0,7874	20,0000	.	2,7953	71,0000
3/32"	0,0938	2,3813	51/64"	0,7969	20,2406	.	2,8346	72,0000
.	0,0945	2,4000	.	0,8071	20,5000	.	2,8740	73,0000
.	0,0984	2,5000	13/16"	0,8125	20,6375	.	2,9134	74,0000
7/64"	0,1094	2,7781	.	0,8268	21,0000	.	2,9528	75,0000
.	0,1181	3,0000	53/64"	0,8281	21,0344	.	2,9921	76,0000
1/8"	0,1250	3,1750	27/32"	0,8438	21,4313	3"	3,0000	76,2000
.	0,1378	3,5000	.	0,8465	21,5000	.	3,0315	77,0000
9/64"	0,1406	3,5719	55/64"	0,8594	21,8281	.	3,0709	78,0000
5/32"	0,1563	3,9688	.	0,8661	22,0000	.	3,1102	79,0000
.	0,1575	4,0000	7/8"	0,8750	22,2250	.	3,1496	80,0000
11/64"	0,1719	4,3656	.	0,8858	22,5000	.	3,1890	81,0000
.	0,1772	4,5000	57/64"	0,8906	22,6219	.	3,2283	82,0000
3/16"	0,1875	4,7625	.	0,9055	23,0000	.	3,2677	83,0000
.	0,1969	5,0000	29/32"	0,9063	23,0188	.	3,3071	84,0000
13/64"	0,2031	5,1594	59/64"	0,9219	23,4156	.	3,3465	85,0000
.	0,2165	5,5000	.	0,9252	23,5000	.	3,3858	86,0000
7/32"	0,2188	5,5563	15/16"	0,9375	23,8125	.	3,4252	87,0000
15/64"	0,2344	5,9531	.	0,9449	24,0000	.	3,4646	88,0000
.	0,2362	6,0000	61/64"	0,9531	24,2094	3 1/2"	3,5000	88,9000
1/4"	0,2500	6,3500	.	0,9646	24,5000	.	3,5039	89,0000
.	0,2559	6,5000	31/32"	0,9688	24,6063	.	3,5433	90,0000
17/64"	0,2656	6,7469	.	0,9843	25,0000	.	3,5827	91,0000
.	0,2756	7,0000	63/64"	0,9844	25,0031	.	3,6220	92,0000
9/32"	0,2813	7,1438	1"	1,0000	25,4000	.	3,6614	93,0000
.	0,2953	7,5000	.	1,0039	25,5000	.	3,7008	94,0000
19/64"	0,2969	7,5406	.	1,0236	26,0000	.	3,7402	95,0000
5/16"	0,3125	7,9375	.	1,0433	26,5000	.	3,7795	96,0000
.	0,3150	8,0000	.	1,0630	27,0000	.	3,8189	97,0000
21/64"	0,3281	8,3344	.	1,0827	27,5000	.	3,8583	98,0000
.	0,3346	8,5000	.	1,1024	28,0000	.	3,8976	99,0000
11/32"	0,3438	8,7313	.	1,1220	28,5000	.	3,9370	100,0000
.	0,3543	9,0000	.	1,1417	29,0000	4"	4,0000	101,6000
23/64"	0,3594	9,1281	.	1,1614	29,5000	.	4,3307	110,0000
.	0,3740	9,5000	.	1,1811	30,0000	4 1/2"	4,5000	114,3000
3/8"	0,3750	9,5250	.	1,2205	31,0000	.	4,7244	120,0000
25/64"	0,3906	9,9219	1 1/4"	1,2500	31,7500	5"	5,0000	127,0000
.	0,3937	10,0000	.	1,2598	32,0000	.	5,1181	130,0000
13/32"	0,4063	10,3188	.	1,2992	33,0000	.	5,5118	140,0000
.	0,4134	10,5000	.	1,3386	34,0000	.	5,9055	150,0000
27/64"	0,4219	10,7156	.	1,3780	35,0000	6"	6,0000	152,4000
.	0,4331	11,0000	.	1,4173	36,0000	.	6,2992	160,0000
7/16"	0,4375	11,1125	.	1,4567	37,0000	.	6,6929	170,0000
.	0,4528	11,5000	.	1,4961	38,0000	.	7,0866	180,0000
29/64"	0,4531	11,5094	1 1/2"	1,5000	38,1000	.	7,4803	190,0000
15/32"	0,4688	11,9063	.	1,5354	39,0000	.	7,8740	200,0000
.	0,4724	12,0000	.	1,5748	40,0000	8"	8,0000	203,2000
31/64"	0,4844	12,3031	.	1,6142	41,0000	.	9,8425	250,0000
.	0,4921	12,5000	.	1,6535	42,0000	10"	10,0000	254,0000
1/2"	0,5000	12,7000	.	1,6929	43,0000	20"	20,0000	508,0000
.	0,5118	13,0000	.	1,7323	44,0000	30"	30,0000	762,0000
33/64"	0,5156	13,0969	1 3/4"	1,7500	44,4500	40"	40,0000	1016,0000
17/32"	0,5313	13,4938	.	1,7717	45,0000	60"	60,0000	1524,0000
.	0,5315	13,5000	.	1,8110	46,0000	80"	80,0000	2032,0000
35/64"	0,5469	13,8906	.	1,8504	47,0000	100"	100,0000	2540,0000

NORMAS

¿Qué es una norma?

Una norma es un documento que proporciona requisitos, especificaciones, directrices o características que se pueden utilizar consistentemente para asegurar que los materiales, productos, procesos y servicios se adecúan a su propósito.

¿Cuáles son los beneficios de las Normas Internacionales ISO?

Las Normas Internacionales ISO garantizan que los productos y servicios son seguros, fiables y de buena calidad. Para el negocio, son herramientas estratégicas que reducen los costos al minimizar los residuos y errores, e incrementando la productividad. Ayudan a empresas a acceder a nuevos mercados, igualando el campo de juego para los países en desarrollo y facilitando el comercio global justo y libre.

IRIMO principales familias de productos

Llaves de vaso

- ISO 2725, vasos, dimensiones generales; ISO 1174, tamaños. Las normas definen los límites de ciertas dimensiones evitando el juego entre el vaso y el perno, la accesibilidad para llegar, y garantiza la transmisión del par correcto y trabajar con las tuercas y pernos.
- ISO 1711, vasos y vasos de impacto, define la dureza mínima que debe tener un vaso, y el par mínimo que debe resistir.
Esto asegura que sólo el material adecuado ha sido utilizado, y que el vaso puede ser usado sin riesgo de rotura.
- El perfil de los vasos, hexagonal y bihexagonal, fue diseñado para una mejor distribución de la fuerza lejos de las esquinas para evitar posibles roturas. Al mismo tiempo la transmisión del par a los pernos y a las tuercas se hace fuera de los bordes, protegiendo la vida de los componentes.

Llaves ajustables

- Supera los valores ISO 6787 de par en más 30 % sin abrirse ni deformarse.
- Las dimensiones de las llaves ajustables son acordes a los estándares de la norma ISO 6787.
- Diseño forjado en una sola pieza.

Llaves

- Norma ISO 1711-1 valores de par estándar, además de un 30 % sin abrir y deformación.
- Dureza superior, conforme a la norma ISO 1711-1, sin riesgo de fragilidad.
- Tolerancia de ajuste de acuerdo con Norma ISO 691 da un mayor rendimiento y una mejor transmisión del par de torsión a los pernos y tuercas.

Alicates

- Las Normas ISO sobre alicates definen, para cada familia de productos, las dimensiones básicas del producto. Además de esto, cuando las normas ISO son aplicables también definen:
 - Deformaciones máximas aceptables después de una prueba de carga.
 - Deformaciones máximas aceptables después de una prueba de torsión.
 - Pruebas de fuerza de corte máximo aceptable.
 - Las Normas ISO más importantes para alicates son:
 - ISO 5745 Alicates para agarrar y manipular
 - Dimensiones y valores de prueba
 - ISO 5746 Alicates para ingenieros e instaladores
 - Dimensiones y valores de prueba
 - ISO 5749 Alicates de corte diagonal
 - Dimensiones y valores de prueba
 - ISO 8976 Tenacillas de ajuste rápido
 - Dimensiones y valores de prueba
 - ISO 9242 Pinzas de los trabajadores de Construcción – Dimensiones y valores de prueba
 - ISO 9243 Alicates y tenazas de carpintero
 - Dimensiones y valores de prueba

Llaves dinamométricas

ISO 6789 clasifica las llaves dinamométricas en diferentes tipos (I, II) y clases (A, B, C, D, E, F). La norma ISO asigna diferentes niveles de precisión (4 % o 6 %) dependiendo del tipo, clase y par máximo de cada llave.

Esta precisión debe llevarse a cabo entre 20 % y 100 % del par máximo de la llave.

La norma también tanto se establece el procedimiento de calibración, las condiciones y la frecuencia, así como otras pruebas y requerimientos de productos.

Las herramientas dinamométricas IRIMO cumplen con la norma ISO 6789 y SNA Europe ofrece servicios de calibración en sus centro post venta.

Destornilladores

Las Normas ISO sobre destornilladores definen la dimensión de punta, la dureza mínima y el par mínimo que deben resistir.

Después de la prueba de par con el valor mínimo, los destornilladores no deberían mostrar ninguna deformación en la punta:

- ISO 2380 Destornilladores de boca estampada
 - Dimensiones, dureza y valores de par mínimos.
- ISO 8764 Destornilladores Phillips y Pozidriv
 - Dimensiones, dureza y valores de par mínimos.
- ISO 2936 Destornilladores hexagonales
 - Dimensiones, dureza y valores de par mínimos.

Sin embargo, los destornilladores IRIMO deben cumplir con las Normas internas que están por encima de la norma ISO.

Las normas internas de los valores de par es un 20 % más que el estándar ISO para destornilladores de boca estampada y 50 % en el Phillips y Pozidriv.

La combinación de la materia prima y la dureza determina el rendimiento de la varilla, dándole un vida más larga y un trabajo de calidad.

Dureza interna; Mínimo SNA Europe 58-59 HRc. Mínimo Normativa ISO 54 HRc.

Vasos con punta TORX®; los valores de par son evaluados con galgas de Acument Global Technologies Inc., que licencia TORX®.

SNA Europe tiene el compromiso de suministrar a sus clientes productos que garantizan el cumplimiento estricto de todos los reglamentos, protocolos internacionales y normas a las que estén sujetos nuestros clientes. En base a esto, SNA Europe cumple con los reglamentos y directivas internacionales exigidas, incluyendo el REACH, minerales conflictivos, etc.

REACH es el Reglamento europeo CE N°1907/2006, que establece la obligación de realizar un registro para todo aquel que introduzca sustancias químicas en el mercado comunitario con una concentración superior al 0,1 %, peso sobre peso, ya sean fabricantes o importadores de sustancias, como tales o en forma de preparados, o productores de artículos (<http://www.echa.europa.eu/candidate-list-table>). Además, la Agencia Europea de Sustancias y Mezclas Químicas (ECHA) ha añadido varias sustancias químicas a la lista de sustancias altamente preocupantes (SVHC) que requieren autorización. Siendo, desde diciembre de 2014, 161 las sustancias que se registran en mencionada lista.

La definición y objetivo de la directiva RoHS es bastante simple. Persigue restringir determinadas sustancias peligrosas usadas de manera habitual en electrónica y equipamiento electrónico. Cualquier componente que cumpla RoHS es testado para determinar la presencia de plomo (Pb), cadmio (Cd), mercurio (Hg), cromo hexavalente (Hex-Cr), bifenilos polibromados (PBB) y éteres de difenilo polibromados (PBDE).

La directiva de equipos electrónicos y residuos de aparatos eléctricos (Directiva WEEE) es la directiva de la Comunidad Europea 2012/19/EU relativa a los residuos eléctricos y de aparatos electrónicos (WEEE) que, junto con la directiva RoHS 2002/95/EC, se convirtió en Ley Europea en febrero de 2003. La Directiva WEEE establece objetivos de recogida, reciclado y recuperación de todo tipo de aparatos eléctricos, con una tasa mínima de 4 kilogramos por habitante por año recuperado para su reciclaje en 2009.

El marcado **CE** es la declaración del fabricante de que el producto cumple con los requisitos de las directivas comunitarias aplicables.

El término Minerales conflictivos se refiere a las materias primas que provienen de una parte determinada del mundo en el que se están produciendo conflictos que afectan a la minería y el comercio de esos materiales. Estos se define como la columbita-tantalita, también conocido como coltán (del que se deriva el tántalo); casiterita (estaño); oro; wolframita (tungsteno); o sus derivados; de ser la financiación de conflicto en la República Democrática del Congo o un país colindante.

SNA Europe



Para información sobre la garantía
visite la página web local

www.irimo.com/es_es/

CONDICIONES DE VENTA

1. Las presentes Condiciones Generales estarán en vigor desde el 1 de Febrero de 2024 y vienen a sustituir y dejar sin efecto a todas las Condiciones Generales anteriormente aplicadas.

2. Nuestros productos se identifican, exclusivamente, por sus referencias. Por ello, los pedidos deben mencionar, claramente en cada caso, la referencia y el número de unidades de la misma que se desea adquirir. Una vez aceptado el pedido, la obligación de SNA Europe Industries Iberia, S.A. queda limitada al suministro de dichas unidades de la referencia solicitada. Las dimensiones y características técnicas de los productos que se incluyen en nuestro catálogo comercial, son meramente ilustrativas y están sujetas a modificaciones, por lo que SNA Europe Industries Iberia, S.A. recomienda a sus clientes que, antes de formular un pedido, comprueben que la referencia solicitada se ajusta, en cuanto a dimensiones y demás características a sus necesidades.

3. SNA Europe establece un importe mínimo por pedido de 100 € a portes pagados, para la aceptación de los mismos.

4. Los precios para envíos a las provincias españolas fuera de la península se entienden para mercancía puesta en el puerto de destino (C & F).

5. La elección del medio de transporte será por cuenta de SNA Europe Industries Iberia, S.A.

6. Los clientes tienen la obligación de examinar los productos servidos a su recepción, a fin de comprobar su conformidad con el pedido en cuanto a la referencia o referencias servidas y el número de unidades entregadas. Si existiera alguna disconformidad, el cliente deberá ponerlo de manifiesto, bien rechazando la mercancía si su disconformidad es total, bien recibéndola parcialmente y haciendo constar en el albarán de entrega su queja en cuanto al producto rechazado en el caso de disconformidad parcial. La firma del albarán de entregas, sin salvedad alguna, supondrá la aceptación de la mercancía y la conformidad del cliente en cuanto a la cantidad y referencia(s) servida(s), todo ello sin perjuicio de la garantía de producto aquí prevista.

7. La transmisión de la propiedad de la mercancía en favor del cliente no tendrá lugar hasta el momento de la efectividad del completo pago de su precio, con independencia de que la misma haya sido entregada y puesta a disposición del cliente. En este caso, y hasta la efectiva transmisión de la propiedad mediante el pago, el cliente se abstendrá de realizar cualquier acto de disposición sobre la mercancía o de almacenarla y/o utilizarla de forma tal que pueda sufrir algún menoscabo, siendo responsable frente a SNA Europe Industries Iberia, S.A. del estado de la misma en este tiempo. En el supuesto de que, llegado el vencimiento del pago, este no se haga efectivo por el cliente, SNA Europe Industries Iberia, S.A. tendrá la facultad alternativa de exigir el pago del precio, con sus intereses o la devolución de la mercancía, sin perjuicio en cualquiera de ambos casos de las indemnizaciones de daños y perjuicios a la que por ley tenga derecho.

8. La mercancía será servida en función de las circunstancias del pedido (Número de unidades y clase de la referencia solicitada) y de la disponibilidad de producto de SNA Europe Industries Iberia, S.A. en el momento. Si el cliente precisa que la entrega se realice en un plazo determinado deberá ponerlo de manifiesto en su escrito de pedido, no habiendo lugar a ninguna reclamación por retraso en la entrega, salvo que expresamente se pacte otra cosa.

9. Forma de pago: A 60 días fecha factura. Los clientes que tengan día de vencimiento fijo, se les girará al más próximo a los 60 días

fecha factura, de forma que todos los giros quedarán comprendidos entre los 45 y 75 días f.f.

10. Los pedidos, una vez aceptados por SNA Europe Industries Iberia, S.A., serán irrevocables y no podrán ser anulados o modificados de ninguna manera por el cliente, salvo que medie expreso acuerdo en dicho sentido con SNA Europe Industries Iberia, S.A. Si un pedido, por la especial naturaleza de su objeto u otras circunstancias, requiere alguna clase de cambio en los procesos de fabricación y/o envasado normalmente seguidos por SNA Europe Industries Iberia, S.A., se considerará como definitivo e irrevocable en todos sus conceptos desde el mismo momento de su emisión por el cliente, viniendo éste obligado a la recepción de la mercancía en todo caso. De no hacerlo así y rehusar la mercancía SNA Europe Industries Iberia, S.A. podrá exigirle el precio del pedido, más un 50 % del mismo, en concepto de penalización.

REPOSICIÓN DE GARANTÍA

1. Todos los productos del catálogo están amparados por la Garantía Total contra cualquier defecto de fabricación o material, de forma que los clientes tendrán derecho a la reposición de la pieza o piezas defectuosas siempre que el defecto tenga su origen directo en la fabricación o de material de la misma.

2. El derecho de reposición se limita a la sustitución de la pieza defectuosa por otra nueva y no comprenderá abono de ninguna clase, siendo todos los gastos de la reposición, en particular el transporte, de cargo del cliente.

3. La Garantía Total no ampara los defectos provenientes del desgaste o de la mala conservación y/o utilización de los productos por el cliente.

4. El plazo de garantía es de un año a partir de la fecha de compra en el caso de los productos sujetos a desgaste normal con el uso tales como cuchillas, puntas, brocas, y otros productos consumibles. En el caso de multiplicadores de par, la garantía no se aplicará en los casos en los que el producto haya sido sometido a esfuerzos superiores a sus valores nominales máximos.

5. Para el correcto ejercicio de este derecho el cliente deberá comunicar por escrito a SNA EUROPE INDUSTRIES IBERIA, S.A. el defecto y las piezas afectadas, indicando los datos relativos a la compra (fecha y número de factura). En el plazo de 30 días a contar desde la recepción de dicha comunicación, SNA EUROPE INDUSTRIES IBERIA, S.A. enviará a su representante de plaza a las instalaciones del cliente, a fin de suscribir conjuntamente la documentación relativa a las piezas defectuosas. Inmediatamente después las mismas o una muestra escogida por el representante de plaza, serán remitidas a SNA EUROPE INDUSTRIES IBERIA, S.A. a fin de que su Departamento de Calidad certifique el defecto. En el supuesto de que el informe del Departamento de Calidad confirme el defecto, SNA EUROPE INDUSTRIES IBERIA, S.A. lo comunicará al cliente, anunciando la reposición de las piezas defectuosas.

6. La reposición se llevará a cabo en el menor plazo de tiempo posible y como norma se producirá junto con el más próximo envío de mercancía al cliente.

7. A la recepción de las piezas repuestas, el cliente deberá suscribir un documento manifestando su conformidad con la reposición efectuada y se renuncia a cualquier reclamación posterior a SNA EUROPE INDUSTRIES IBERIA, S.A. por dicho motivo.

Este catálogo comprende nuestra gama actual de productos. De manera regular se realizan cambios tanto en la gama de productos como en el conformado final, formas, diseños y designaciones de los mismos.

Estas modificaciones no serán necesariamente notificadas.

Las ilustraciones y croquis han sido reproducidos para ser lo más precisos posibles. Sin embargo, en la elaboración de un catálogo, los mismos pueden diferir respecto a los propios productos y a las especificaciones técnicas.

Las indicaciones de peso deben entenderse como pesos netos aproximados, y sirven principalmente para facilitar el cálculo de los costes de transporte y franqueo.

Este catálogo reemplaza toda especificación y gamas previas.

La propiedad intelectual de este catálogo pertenece a SNA Europe.

Los extractos, reimpresiones o copias de los contenidos solo se pueden realizar con nuestra autorización.

2024

CONTACTO

Argentina

A.M. de Justo 1750 3° A
C1107AFJ - Capital Federal
Buenos Aires
Tel: +54 (11) 4313-1004
Fax: +54 (11) 4893-3553

Australia

3 Cooper Street, Smithfield,
NSW 2164
Tel: +61 (0) 2 8787 5700
Fax: +61 (0) 2 9756 6130

Беларусь

ЗАО "Эс-Эн-Эй Европа Индастриз Бисов"
220075 СЭЗ "Минск"
ул. Селицкого, д. 8А
Телефон +375 (17) 389 79 50
info.by@snaeurope.com

Belgium

Branch of SNA Europe (Benelux) BV
De Kleetlaan 12A Pegasus Park
1831 DIEGEM
Tel: +32 (0)2 726 03 03
Fax: +32 (0)2 726 04 36

Chile

Av. Americo Vespuccio 2760-D
Conchali - Santiago - Chile
Tel: + 56 2 623 0203
Fax: + 56 2 623 5395

Česká republika

SNA Europe s.r.o.
Holadnská 2/4
639 00 Brno
Tel: +420 537 022 520
Fax: +420 537 022 200

Danmark

Vallensbækvej 40,
2605 Brøndby
Tel: +45 4363 0330
Fax: +45 4396 2456

Deutschland

Willetstraße 10
40822 Mettmann
Tel: +49 (0) 2104 833 83 0
Fax: +49 (0) 2104 833 83 7999

España

c/ Hilanderas, 1
(P.O. Box / Apdo de Correos nº 5)
C.P. 20303 Irún
Tel: +34 902 235 100 / +34 943 649 111
Fax: +34 943 649 120

Ελλάδα

Λ. Βουλιαγμένης 604Γ
167 77 Ελληνικό, Αθήνα
Τηλ: +30 210 9914263
Fax: +30 210 9914587

Export

Antigua Carretera de Altube Km 5,5
P.O.Box 307
01080 VITORIA (Spain)
Tel: +34 945269711
Fax: +34 945165040

France

ZAC de l'Hoirie
20 rue Charles Lacretelle
CS 60101
49072 Beaucouzé cedex
Tél: +33 (0) 2 41 22 98 40
Fax: +33 (0) 2 41 22 98 50

Italia

SNA EUROPE Italia S.p.A.
Via Georges Bizet, 13/15
20092 Cinisello Balsamo MI - Italia
Tel. +39 02 3024161
info.it@snaeurope.com

Казахстан

050000, Алматы,
ул.Шевченко 1656/72г, оф.217
Тел/факс +7 727323 63 39

Nederland

Vossenbeemd 113
5705 CL Helmond
Tel: +31 (0) 492 58 23 82
Fax: +31(0) 492 58 23 20

New Zealand

Unit 3/25 Highbrook Drive
East Tamaki
Auckland
Tel: +64 9-273 46 50
Fax: +64-9-273-2453

Norge

Box 800
1306 Sandvika
Tel: +47 40 49 66 00
Fax: +47 67 17 56 51

Österreich

Vienna, Nineteen, Mooslackengasse 17
A - 1190 Wien
Tel: +49 (0) 2104 8 33 83 0
Fax +49 (0) 2104 833 83 79 99

Polska

ul. Marynarska 15
02-674 Warszawa
Tel.: +48 (0) 22 6070510
Fax: +48 (0) 22 6070521

Россия

ООО "Эс-Эн-Эй Юроп (РУС)"
141407 г. Химки
ул. Панфилова вл.21, стр.1
Телефон +7 (495) 221 58 51
info.ru@snaeurope.com

Portugal

SNA Europe [Industries] LDA
R. Maria Julia M. Ramos - Junqueira
4480-254 Vila Do Conde
Tel. +351 252 650 131
Fax. +351 252 650 160

Slovenská republika

SNA Europe s.r.o.
Karadžičova 8/A
821 08 Bratislava
Tel: +421 (0)2 5939 6124
Fax: +421 (0)2 5939 6217

SRBIJA

Vermax-alati doo
Ul. Drage Spasić 35
11000 Beograd
Tel: +381 11 2360 500
Tel: +381 11 2360 900
Fax: +381 11 2361 147
e-mail: office@vermax.rs

Suomi

SNA Europe Oy
PL 6580
00002 Helsinki
Finland
Tel: +358 207 433 510
Fax: +358 207 433 525

Sverige

SNA Europe Industries AB
Box 83
SE-745 22 Enköping
Tel: +46 (0) 171-47 82 00
Fax: +46 (0) 171-47 82 38

Schweiz / Suisse

Willetstraße 10
40822 Mettmann
Tel: +49 (0) 2104 833 83 0
Fax: +49 (0) 2104 833 83 7999

Türkiye

Girne Mah. Maltepe Küçük San. Sitesi
F Blok No:19 Maltepe
Istanbul
Tel: +90 (0) 216 367 10 21
Fax: +90 (0) 216 367 11 71

Украина

«Бахко Бисов Свенска Акциеболаг»
SNA Europe [Ukraine & Moldova]
Телефон +38 067 441 16 09
офис 555, улица Армянская, 6А
Киев, Украина

United Kingdom

Moorhead Way, Bramley,
Rotherham, South Yorkshire S66 1YY
Tel: +44 (0) 1709 731731
Fax: +44 (0) 1709 731741

